

BALDOR® • RELIANCE 

Product Information Packet

EM3613T

5HP,3450RPM,3PH,60HZ,184T,3630M,TEFC,F1

Part Detail							
Revision:	R	Status:	PRD/A	Change #:		Proprietary:	No
Type:	AC	Elec. Spec:	36WGS042	CD Diagram:	CD0005	Mfg Plant:	
Mech. Spec:	36G271	Layout:	36LYG271	Poles:	02	Created Date:	05-10-2010
Base:	RG	Eff. Date:	10-23-2017	Leads:	9#16		

Specs			
Catalog Number:	EM3613T	Insulation Class:	F
Enclosure:	TEFC	Inverter Code:	Inverter Ready
Frame:	184T	KVA Code:	L
Frame Material:	Steel	Lifting Lugs:	No Lifting Lugs
Output @ Frequency:	5.000 HP @ 60 HZ	Locked Bearing Indicator:	No Locked Bearing
Synchronous Speed @ Frequency:	3600 RPM @ 60 HZ	Motor Lead Quantity/Wire Size:	9 @ 16 AWG
Voltage @ Frequency:	460.0 V @ 60 HZ	Motor Lead Exit:	Ko Box
	230.0 V @ 60 HZ	Motor Lead Termination:	Flying Leads
XP Class and Group:	None	Motor Type:	3630M
XP Division:	Not Applicable	Mounting Arrangement:	F1
Agency Approvals:	CSA	Power Factor:	91
	CSA EEV	Product Family:	General Purpose
	UR	Pulley End Bearing Type:	Ball
Auxillary Box:	No Auxillary Box	Pulley Face Code:	Standard
Auxillary Box Lead Termination:	None	Pulley Shaft Indicator:	Standard
Base Indicator:	Rigid	Rodent Screen:	None
Bearing Grease Type:	Polyrex EM (-20F +300F)	Shaft Extension Location:	Pulley End
Blower:	None	Shaft Ground Indicator:	No Shaft Grounding

Current @ Voltage:	11.800 A @ 230.0 V	Shaft Rotation:	Reversible
	5.900 A @ 460.0 V	Shaft Slinger Indicator:	No Slinger
Design Code:	A	Speed Code:	Single Speed
Drip Cover:	No Drip Cover	Motor Standards:	NEMA
Duty Rating:	CONT	Starting Method:	Direct on line
Electrically Isolated Bearing:	Not Electrically Isolated	Thermal Device - Bearing:	None
Feedback Device:	NO FEEDBACK	Thermal Device - Winding:	None
Front Face Code:	Standard	Vibration Sensor Indicator:	No Vibration Sensor
Front Shaft Indicator:	None	Winding Thermal 1:	None
Heater Indicator:	No Heater	Winding Thermal 2:	None

Nameplate NP3441LUA										
CAT.NO.	EM3613T									
SPEC	36G271S042G2									
HP	5									
VOLTS	230/460									
AMPS	11.8/5.9									
RPM	3450									
FRAME	184T				HZ	60			PH	3
SF	1.15		CODE	L	DES	A		CLASS	F	
NEMA NOM. EFF	88.5		PF	91						
RATING	40C AMB-CONT									
CC	010A				USABLE AT 208V					
ENCL	TEFC		SER							
DE	6206			ODE	6205					
VPWM INVERTER READY										
CT6-60H(10:1)VT3-60H(20:1)										
	50Hz 5HP 190/380V 14.2/7.1A								SF1.0	

Parts List		
Part Number	Description	Quantity
SA194650	SA 36G271S042G2	1.000 EA
RA182236	RA 36G271S042G2	1.000 EA
34FN3002B02	EXTERNAL FAN, PLASTIC, .905/.907 HUB W/	1.000 EA
36CB3004	36 CB CASTING W/1.09 DIA LEAD HOLE @ 6:0	1.000 EA
36GS1000SP	GASKET-CONDUIT BOX, .06 THICK #SV-330 LE	1.000 EA
51XB1016A08	10-16X 1/2HXWSSLD SERTYB	2.000 EA
11XW1032G06	10-32 X .38, TAPTITE II, HEX WSHR SLTD U	1.000 EA
36EP3104A01	FREP MACH ASSEMBLY FOR ROUTING	1.000 EA
HW4500A01	1641B(ALEMITE)400 UNIV, GREASE FITT	1.000 EA
HW5100A05	WVY WSHR F/205 & 304 BRGS	1.000 EA
36EP3100A01SP	PUEP ASSEMBLY FOR ROUTING PURPOSES	1.000 EA
HW4500A01	1641B(ALEMITE)400 UNIV, GREASE FITT	1.000 EA
XY2520A12	1/4-20 HEX NUT, DIRECTIONAL SERRATIONS	4.000 EA
36FH4009A102	IEC FH GREASER PRIMED	1.000 EA
51XW1032A06	10-32 X .38, TAPTITE II, HEX WSHR SLTD S	3.000 EA
36CB4516	36 LIPPED CB LID - GALVANNEAL	1.000 EA
37GS1001SP	GASKET, CONDUIT BOX LID, .06 THICK LEXID	1.000 EA
51XW0832A07	8-32 X .44, TAPTITE II, HEX WSHR SLTD SE	4.000 EA
HW2501E16	KEY, 1/4 SQ X 1.750	1.000 EA
HA7000A02	KEY RETAINER RING, 1 1/8 DIA, 1 3/8 DIA	1.000 EA
85XU0407S04	4X1/4 U DRIVE PIN STAINLESS	2.000 EA
MJ1000A02	GREASE, POLYREX EM EXXON (USe 4824-15A)	0.050 LB
51XB1214A16	12-14X1.00 HXWSSLD SERTYB	1.000 EA
HA3101A25	THRUBOLT 1/4-20 X 11.000 OHIO ROD	4.000 EA

Parts List (continued)		
Part Number	Description	Quantity
MG1000Y03	MUNSELL 2.53Y 6.70/ 4.60, GLOSS 20,	0.022 GA
LC0005E01	CONN.DIA./WARNING LABEL (LC0005/LB1119N)	1.000 EA
NP3441LUA	ALUM SUPER-E VPWM INV READY UL CSA-EEV C	1.000 EA
36PA1001	PKG GRP, PRINT PK1017A06	1.000 EA
MN416A01	TAG-INSTAL-MAINT no wire (1200/bx) 5/18	1.000 EA

Accessories		
Part Number	Description	Multiplier
36-3301	C FACE KIT	A8
36EP1304A62SP	FLANGE MTD ENDPLATE 182-4TD -ENCL (LESS	A8

AC Induction Motor Performance Data

Record # 32158 - Typical performance - not guaranteed values

Winding: 36WGS042-R002	Type: 3630M	Enclosure: TEFC
-------------------------------	--------------------	------------------------

Nameplate Data				460 V, 60 Hz: High Voltage Connection	
Rated Output (HP)	5			Full Load Torque	7.67 LB-FT
Volts	230/460			Start Configuration	direct on line
Full Load Amps	11.8/5.9			Breakdown Torque	33.7 LB-FT
R.P.M.	3450			Pull-up Torque	23.5 LB-FT
Hz	60	Phase	3	Locked-rotor Torque	27.5 LB-FT
NEMA Design Code	A	KVA Code	L	Starting Current	57.2 A
Service Factor (S.F.)	1.15			No-load Current	1.68 A
NEMA Nom. Eff.	88.5	Power Factor	91	Line-line Res. @ 25°C	2.3313 Ω
Rating - Duty	40C AMB-CONT			Temp. Rise @ Rated Load	72°C
S.F. Amps				Temp. Rise @ S.F. Load	89°C
				Locked-rotor Power Factor	45
				Rotor inertia	0.134 LB-FT ²

Load Characteristics 460 V, 60 Hz, 5 HP

% of Rated Load	25	50	75	100	125	150	S.F.
Power Factor	62	81	88	91	93	93	92
Efficiency	84.1	88.9	89.4	88.7	87.3	85.8	87.9
Speed	3568.7	3537.4	3504.2	3465.8	3428.2	3385	3443
Line amperes	2.24	3.26	4.47	5.85	7.26	8.8	6.7

Performance Graph at 460V, 60Hz, 5.0HP Typical performance - Not guaranteed values

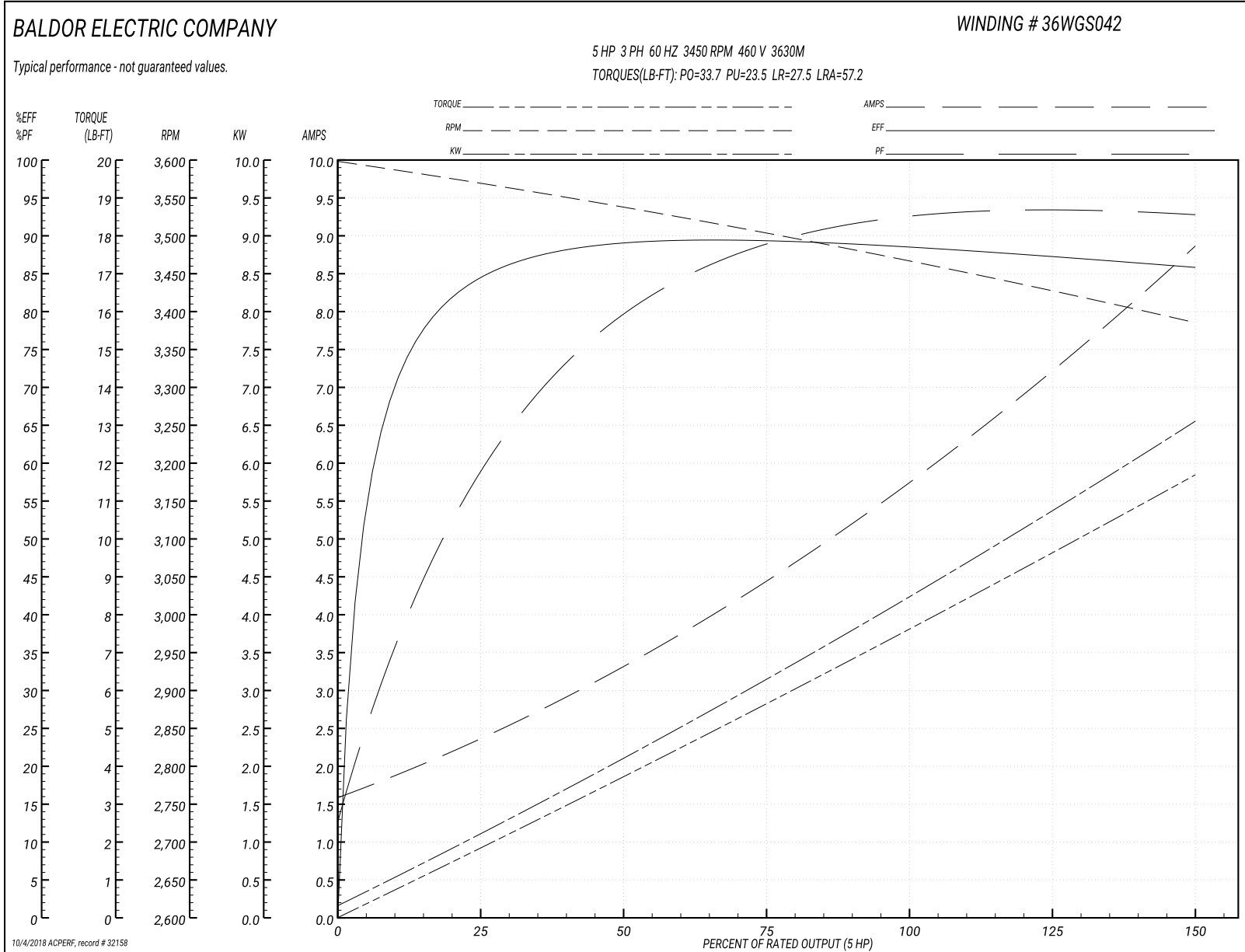

AC Induction Motor Performance Data

Record # 50850 - Typical performance - not guaranteed values

Winding: 36WGS042-R002	Type: 3630M	Enclosure: TEFC
-------------------------------	--------------------	------------------------

Nameplate Data				480 V, 60 Hz: High Voltage Connection	
Rated Output (HP)	5			Full Load Torque	7.64 LB-FT
Volts	230/460			Start Configuration	direct on line
Full Load Amps	11.8/5.9			Breakdown Torque	37.2 LB-FT
R.P.M.	3450			Pull-up Torque	26.4 LB-FT
Hz	60	Phase	3	Locked-rotor Torque	30.9 LB-FT
NEMA Design Code	A	KVA Code	L	Starting Current	60.6 A
Service Factor (S.F.)	1.15			No-load Current	1.91 A
NEMA Nom. Eff.	88.5	Power Factor	91	Line-line Res. @ 25°C	2.26 Ω
Rating - Duty	40C AMB-CONT			Temp. Rise @ Rated Load	71°C
S.F. Amps				Temp. Rise @ S.F. Load	85°C
				Locked-rotor Power Factor	45.7
				Rotor inertia	0.134 LB-FT ²

Load Characteristics 480 V, 60 Hz, 5 HP

% of Rated Load	25	50	75	100	125	150	S.F.
Power Factor	56	77	86	90	92	93	91
Efficiency	83.3	88.5	89.4	88.7	87.6	86	88
Speed	3571	3541	3511	3475	3440	3400	3454
Line amperes	2.39	3.32	4.43	5.71	7.03	8.46	6.5

Performance Graph at 480V, 60Hz, 5.0HP Typical performance - Not guaranteed values

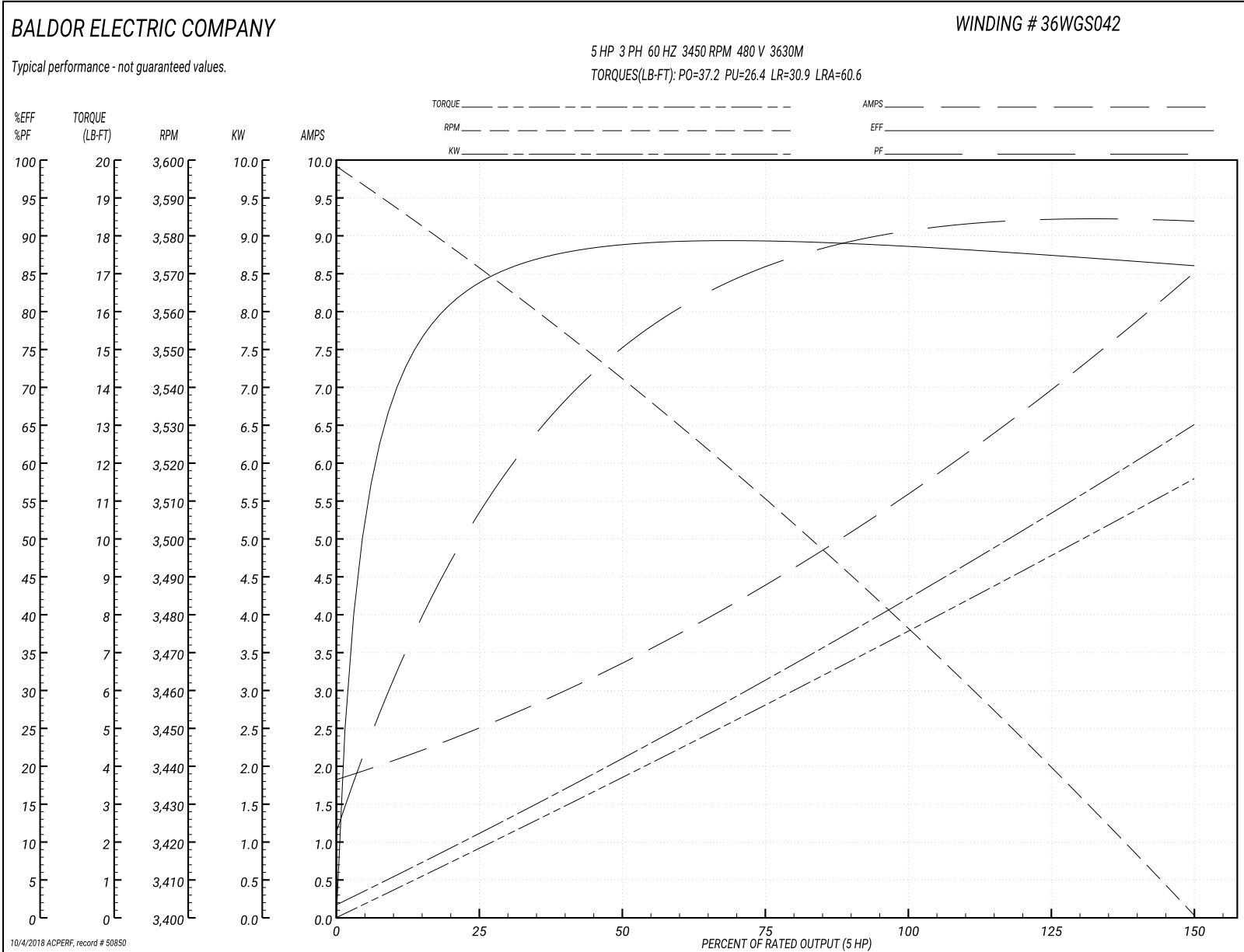

AC Induction Motor Performance Data

Record # 51386 - Typical performance - not guaranteed values

Winding: 36WGS042-R002	Type: 3630M	Enclosure: TEFC
-------------------------------	--------------------	------------------------

Nameplate Data				207 V, 60 Hz: Low Voltage Connection	
Rated Output (HP)	5			Full Load Torque	7.73 LB-FT
Volts	230/460			Start Configuration	direct on line
Full Load Amps	11.8/5.9			Breakdown Torque	26.7 LB-FT
R.P.M.	3450			Pull-up Torque	18.2 LB-FT
Hz	60	Phase	3	Locked-rotor Torque	21.3 LB-FT
NEMA Design Code	A	KVA Code	L	Starting Current	100 A
Service Factor (S.F.)	1.15			No-load Current	2.7 A
NEMA Nom. Eff.	88.5	Power Factor	91	Line-line Res. @ 25°C	0.566 Ω
Rating - Duty	40C AMB-CONT			Temp. Rise @ Rated Load	78°C
S.F. Amps				Temp. Rise @ S.F. Load	99°C
				Locked-rotor Power Factor	44
				Rotor inertia	0.134 LB-FT ²

Load Characteristics 207 V, 60 Hz, 5 HP

% of Rated Load	25	50	75	100	125	150	S.F.
Power Factor	73	87	92	94	94	94	94
Efficiency	85.8	89.5	89.3	88	86.1	84.3	86.9
Speed	3563	3525	3485	3439	3392	3338	3411
Line amperes	4.17	6.68	9.54	12.8	16.1	19.9	14.8

Performance Graph at 207V, 60Hz, 5.0HP Typical performance - Not guaranteed values

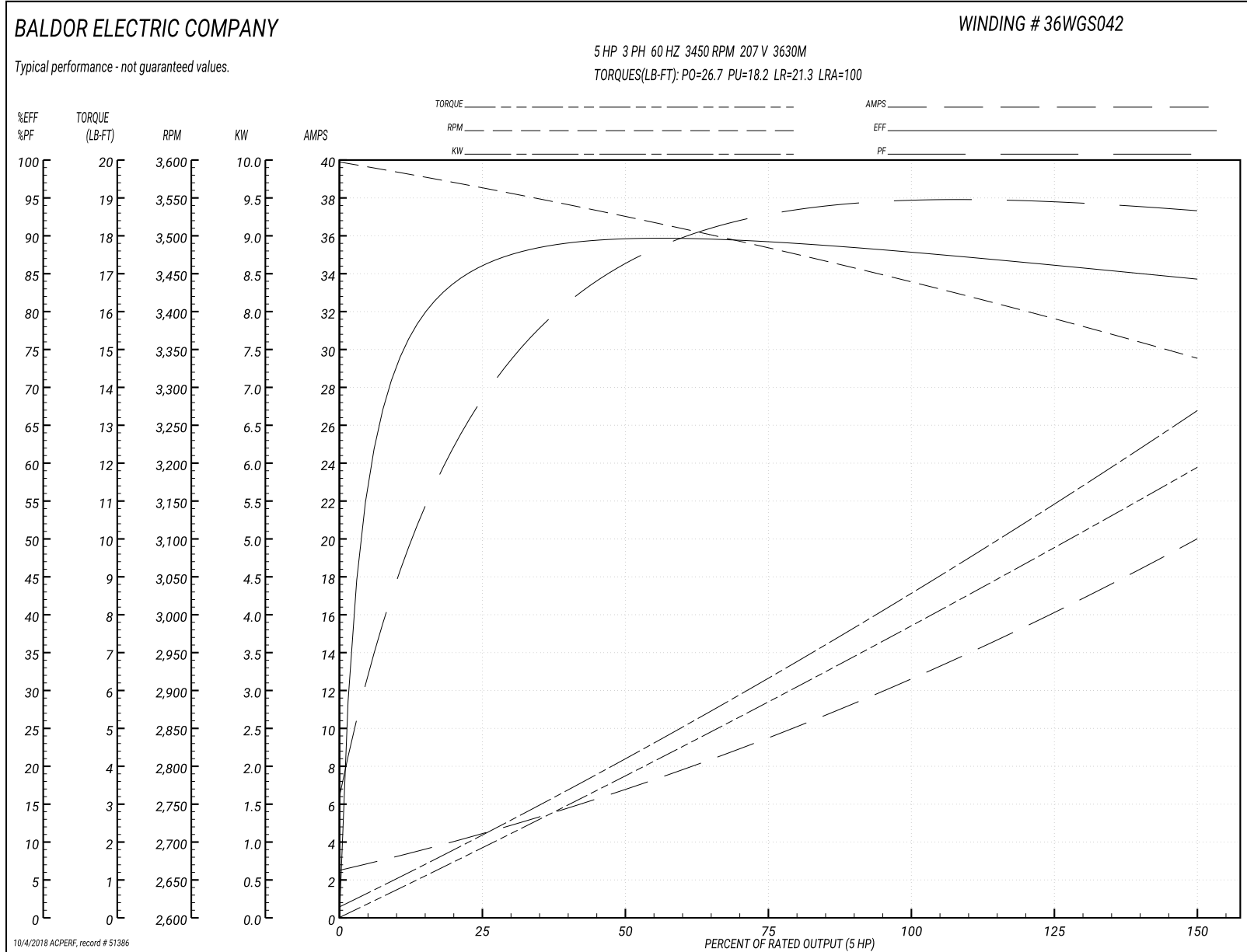

AC Induction Motor Performance Data

Record # 59341 - Typical performance - not guaranteed values

Winding: 36WGS042-R002	Type: 3630M	Enclosure: TEFC
-------------------------------	--------------------	------------------------

Nameplate Data				230 V, 60 Hz: Low Voltage Connection	
Rated Output (HP)	5			Full Load Torque	7.67 LB-FT
Volts	230/460			Start Configuration	direct on line
Full Load Amps	11.8/5.9			Breakdown Torque	33.7 LB-FT
R.P.M.	3450			Pull-up Torque	23.5 LB-FT
Hz	60	Phase	3	Locked-rotor Torque	27.5 LB-FT
NEMA Design Code	A	KVA Code	L	Starting Current	114 A
Service Factor (S.F.)	1.15			No-load Current	3.36 A
NEMA Nom. Eff.	88.5	Power Factor	91	Line-line Res. @ 25°C	0.576 Ω
Rating - Duty	40C AMB-CONT			Temp. Rise @ Rated Load	72°C
S.F. Amps				Temp. Rise @ S.F. Load	88°C
				Locked-rotor Power Factor	45.4
				Rotor inertia	0.134 LB-FT ²

Load Characteristics 230 V, 60 Hz, 5 HP

% of Rated Load	25	50	75	100	125	150	S.F.
Power Factor	62	81	88	91	93	94	92
Efficiency	84.1	88.9	89.4	88.7	87.3	85.8	87.9
Speed	3569	3537	3504	3466	3428	3385	3443
Line amperes	4.48	6.52	8.94	11.7	14.5	17.6	13.4

Performance Graph at 230V, 60Hz, 5.0HP Typical performance - Not guaranteed values

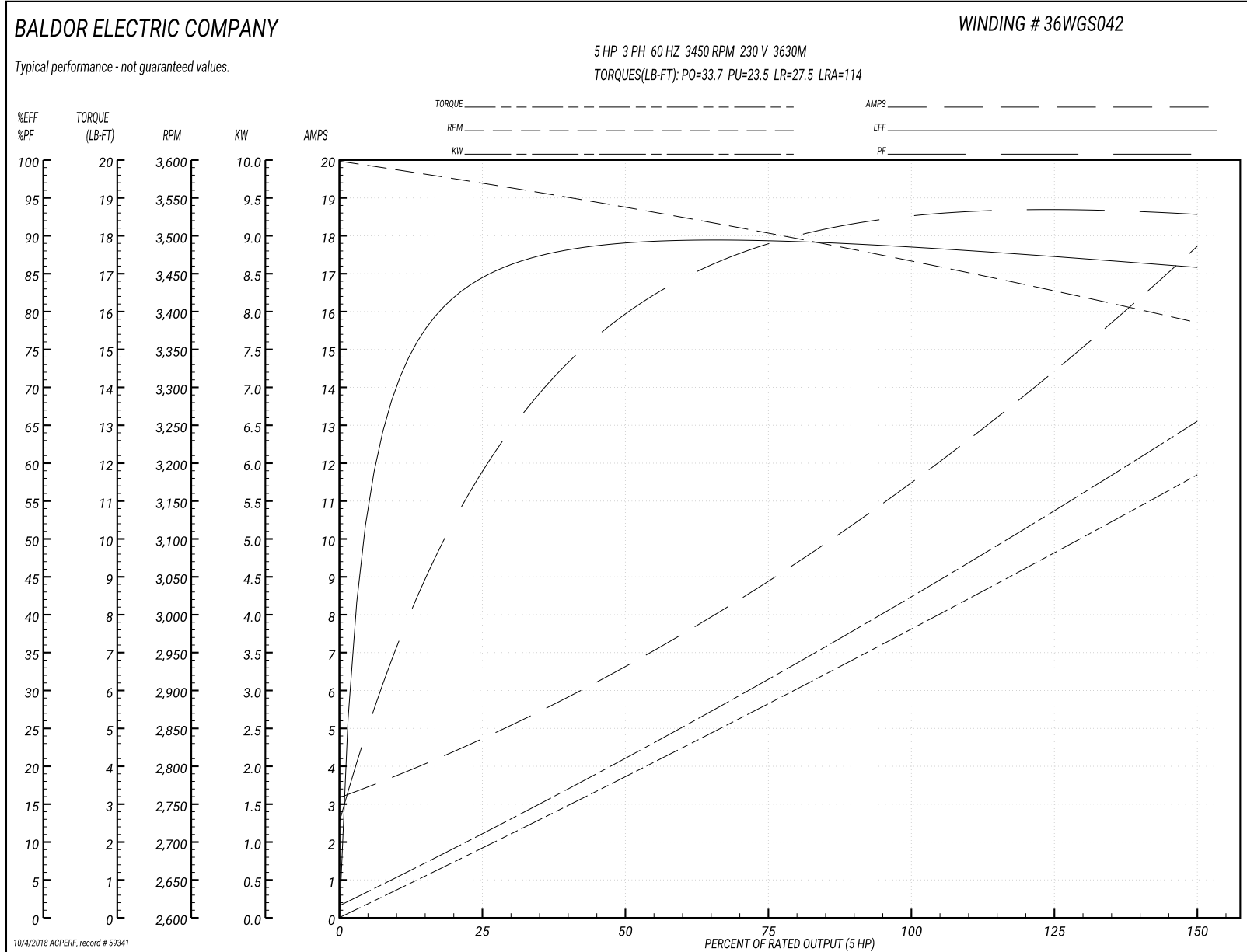

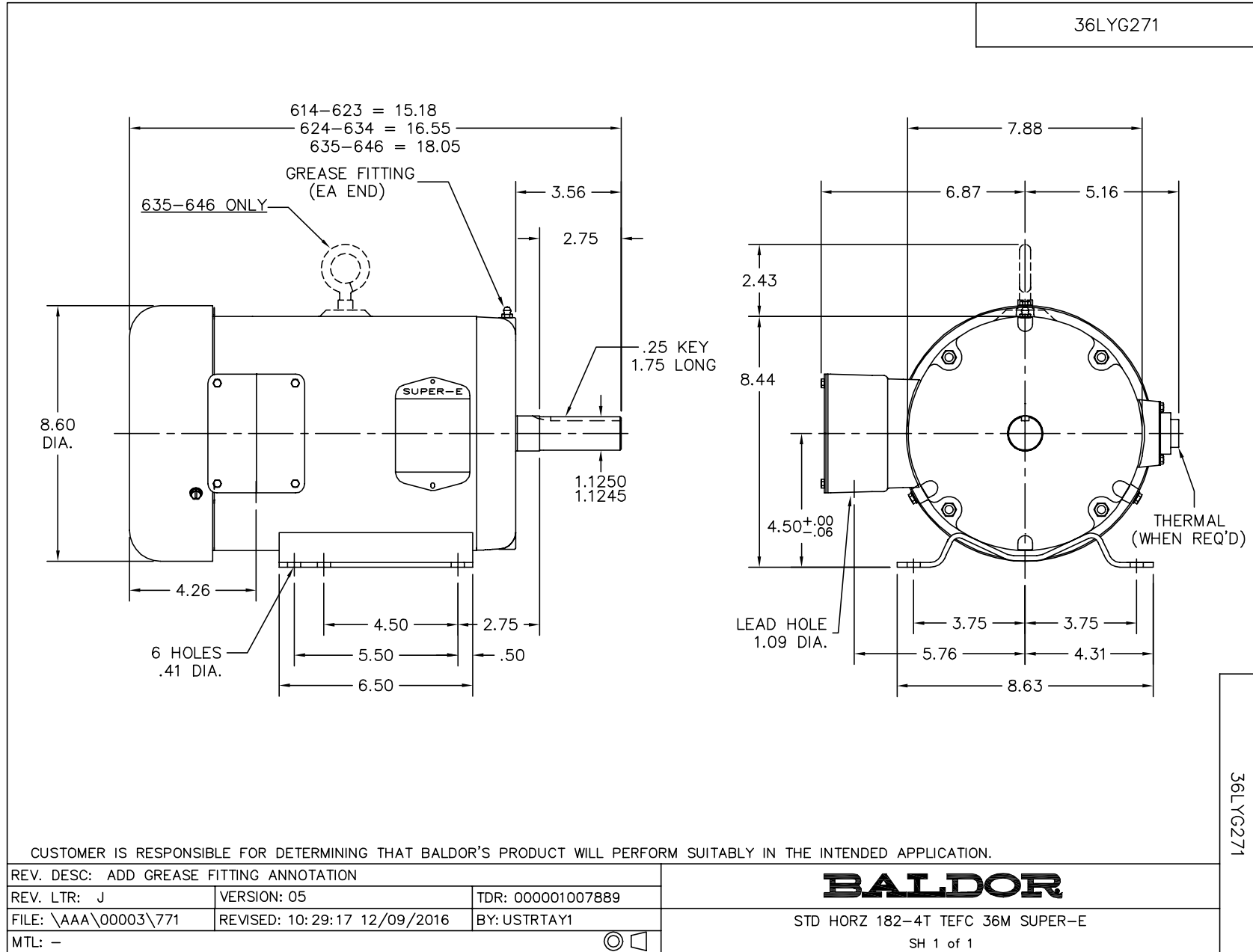

CD0005

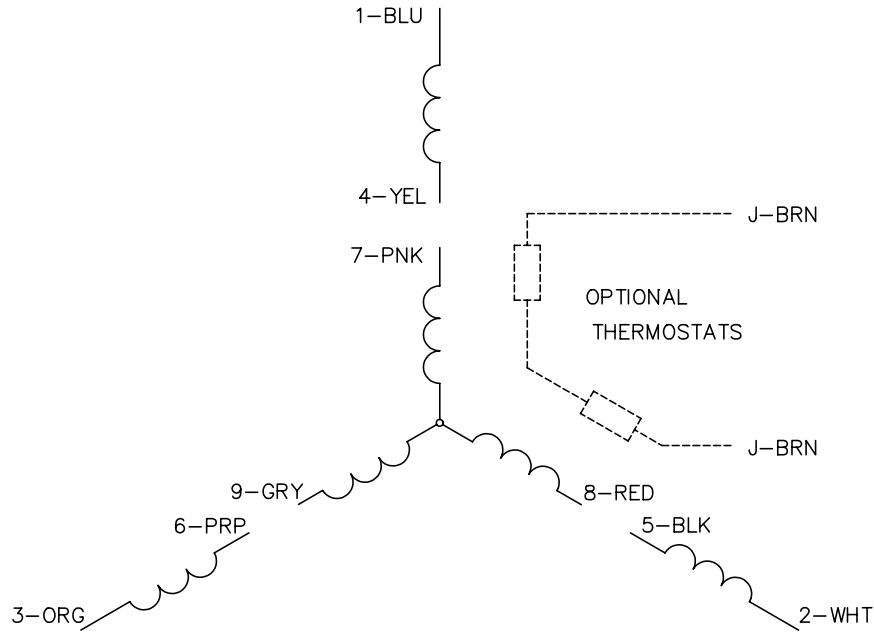

LOW VOLTAGE
(2Y)

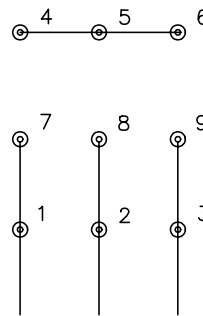

LINE

HIGH VOLTAGE
(1Y)

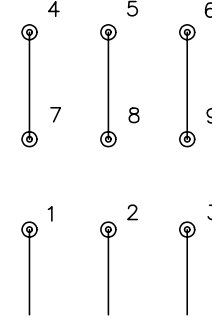

LINE

NOTES:

1. INTERCHANGE ANY TWO LINE LEADS TO REVERSE ROTATION.
2. OPTIONAL THERMOSTATS ARE PROVIDED WHEN SPECIFIED.
3. ACTUAL NUMBER OF INTERNAL PARALLEL CIRCUITS MAY BE A MULTIPLE OF THOSE SHOWN ABOVE.
4. LEAD COLORS ARE OPTIONAL. LEADS MUST ALWAYS BE NUMBERED AS SHOWN.

REV. DESC: REVISE TO SHOW OPTIONAL COLORS			
REV. LTR: E	BY: JLP	REVISED: 01/19/99 10:15	TDR: 0171435
90000		FILE: AAA00005140	MDL: -
		MTL: -	

BALDOR ELECTRIC Co.

3PH, DV, 9 LEADS

CD0005