

Table of Contents**Page****Section I – Introduction**

MRC History	6
Catalog and speed rating disclaimer	7
Warranty statement	7
Identification system	8
Bearing symbols	9
Identification of non-standard variants	26
Descriptive manufacturing suffixes	29
Telephone and fax numbers	31

Section II – Bearing Specification Tables

MRC Bearing Series	39
Ball Bearing Variations	40
Single-row deep groove, type S	43
Single-row deep groove cartridge type SFFC	53
Single-row maximum capacity, filling notch, type M	57
Single-row 15 degree angular contact, type R	65
Single-row 15 degree angular contact, type XLS	76
Single-row 29 degree angular contact, 7000 series	83
Single-row 40 degree angular contact, 7000 P series	97
Single-row 40 degree angular contact, 7000 PJ series	109
Single-row 29 degree angular contact, split ring, 9000 U series	119
Single-row 40 degree angular contact, split ring, 9000 UP series	119
Duplex 29 degree angular contact 97000 U series	129
Duplex 40 degree angular contact 97000UP series	129
Double-row angular contact, 5000 series	139
Self-aligning ball bearings	157
PumPac 8000, 8000 BB and 8000 AAB series	175
Precision ABEC-5 and ABEC-7 bearings	185
Single-row 15 degree angular contact, type R	186
Single-row deep groove, type S, Woodworking Bearings	194
Excello bearings	197
Ball bearing supports	195
Specialty bearings	201
Adapter type	202
Conveyor roll	203
Dynamometer	205
Electric motor quality	209
Felt seal replacement	224
Mast guide	229
Wide inner ring	233

Section III – Engineering Data

Duplex bearings	236
97000 Series	239
ABEC tolerances	241
Shaft and housing fits	247
Internal radial clearance	272
Dynamic and static load ratings	273
Bearing life	274
Speed factors	275
Speed ratings	276
Minimum thrust load for angular contact bearings	277
Minimum radial load for double-row bearings	279
Materials and limitations	281
Lubrication	285

<i>Table of Contents</i>	<i>Page</i>
Section III – Engineering Data (Continued)	
Vibration data	303
Snap ring data	325
Locknuts and lockwashers	329
Locknut torque and clamping force	332
Installation procedures	333
Shaft and housing shoulder diameters	340
Bearing weights.	344
ABMA identification code	347
Millimeter-inch equivalents.	350
Fraction-decimal equivalents.	352
Conversion factors	353
Useful formulae.	356
Product index	379

Section I	Bearing Symbols
------------------	------------------------

Non-Standard Variants

Section II	Single-Row Deep Groove, Type S
-------------------	---------------------------------------

Single-Row Maximum Capacity, Filling Notch, Type M

Single-Row 15 Degree Angular Contact, Type R

Single-Row Angular Contact, 7000, 7000P and 7000PJ Series
--

Single-Row Angular Contact, Split Ring, 9000U, 9000UP, 97000U and 97000UP Series

Double-Row Angular Contact, 5000 Series
--

Self-Aligning Ball Bearings

PumPac 8000, 8000BB and 8000AAB Series

Specialty Bearings

Precision ABEC-5 and ABEC-7 Bearings

Section III	Duplex Bearings
--------------------	------------------------

ABEC Tolerances

Shaft and Housing Fits

Lubrication

Vibration Data

NOTES



Table of Contents

	<i>Page</i>
MRC History	6
Catalog and speed rating disclaimer	7
Warranty statement	7
Identification system	8
Bearing symbols	9
Identification of non-standard variants	26
Descriptive manufacturing suffixes	29
Telephone and fax numbers	31

The Historical Perspective of MRC Bearing Services

MRC Bearing Services is the outgrowth of three of America's oldest bearing companies—Standard Roller Bearing Company, Gurney Ball Bearing Company, and Strom Bearing Company.

The Standard Roller Bearing Company was formed when a Philadelphia industrialist, S. S. Eveland, merged the Ball Bearing Company of Boston with seven other major ball bearing and ball-making equipment manufacturers. The company used the SRB Diamond trademark. SRB made many contributions to the advancement of anti-friction bearings; most notably, the development of 52100 steel, a high carbon, high chrome alloy steel that greatly improved bearing life.

In 1902, Frederick W. Gurney started the manufacture of ball bearing machinery in Jamestown, New York. He originated the Gurney "radial-thrust angular-contact" bearing (today's 7000 Series) in 1905, and the Gurney "radial-Type R" bearing (same designation today) in 1909. Gurney also developed duplex bearings—a matched pair of counterbored bearings—which were a major contribution to the accuracy of high speed machine tool spindles.

Stephen Snyder began manufacturing filling slot radial ball bearings in a small Chicago shop in 1908. His business was incorporated in 1909 as the U.S. Ball Bearing Manufacturing Company. Axel Strom became sole owner and changed the name to Strom Ball Bearing Manufacturing Company. The company established itself as a major supplier of precision ball bearings to the automotive and machinery industries. A major innovation by Strom was engineering service, provided to customers, "to aid in proper choice of ball bearings, their use, and guidance for mounting and maintenance."

Prior to World War I, Albert F. Rockwell, one of two brothers who founded New Departure Company, formed the Rockwell-Drake Corporation to manufacture ball bearings in Plainville, Connecticut. During the war, Rockwell combined Rockwell-Drake Corporation with several other corporations including the Standard Roller Bearing Company of Philadelphia.

After World War I, some of the manufacturing units were liquidated and the company was reorganized as Standard Steel and Bearing, Inc., Division of Marlin

Rockwell Corporation. In 1923, the bearing manufacturing plants were consolidated at Plainville, Connecticut. The following year, Gurney Ball Bearing Company merged with Marlin Rockwell Corporation. MRC purchased Strom Ball Bearing Manufacturing Corporation in 1925 and its assets were moved to Jamestown, New York, in 1931.

The manufacturing experience, technical background, and managerial skills of these antecedent companies provided Marlin Rockwell with a firm base out of which to develop and grow. In 1953, a new state-of-the-art plant was built at Falconer, New York, and an addition to the plant was completed in 1966. The plant was devoted to the manufacture of high-precision ball and roller bearings.

In 1964, Marlin Rockwell Corporation was merged with TRW, Incorporated, and renamed TRW Bearings Division in 1979. With the technological background and facilities of the parent company at its disposal, TRW Bearings Division entered a new period of growth. A ball manufacturing plant was acquired in 1964 at Winstead, Connecticut. In 1976, the Division built a new facility at Gainesville, Georgia, to specialize in high-volume bearing production.

In 1986, the Bearing Division was acquired by the SKF Group, which is an international manufacturing and marketing organization composing approximately 200 companies with 85 factories, together operating in more than 130 countries. SKF sales units are backed up by nearly 200 sales offices and over 10,000 distributors and retailers.

Shortly after the consolidation of major executive and management functions at the Jamestown, New York facilities in the early 1930's, the need for a function within the organization to identify and meet the special needs of our bearing distributor customers was recognized. To provide these services, the forerunner of today's MRC Bearing Services was initiated. From the inception of MRC Bearing Services, the list of services provided to our customers and the quality of the services continued to increase. As the result of over 50 years of experience servicing bearing distributor customers, MRC Bearing Services now provides an impressive list of services designed to help our bearing distributor customers respond to the needs of the aftermarket.

Disclaimer

The contents of this catalog are the copyright of the publishers and may not be reproduced (even extracts) unless permission is granted. Every care has been taken to insure the accuracy of the information contained in this catalog but no liability can be accepted for any errors or omissions.

Listing in this catalog does not necessarily imply product availability. Cage type speed adjustment factor footnotes does not mean that particular cage variants are available.

The designs and load ratings shown in this catalog are those being used at the time of publication. The possibility exists that the designs and ratings may be changed to reflect product improvement or may be procured from a different company facility. To determine current conditions, contact MRC Bearing Services Product Engineering.

Interchange Information

Interchanges provided in this catalog can provide a fast conversion of manufacturer numbers to MRC equivalents. Please note that interchanges are made on an application basis and may not be completely identical to MRC Bearing Services products. Basic interchanges indicate overall compatible design. The interchange information was compiled using data available at the time of publication; however, SKF USA Inc. and MRC Bearing Services assume no responsibility or liability for errors or omissions. Also, bearing illustrations depict closure grooves; however, actual bearings may or may not have closure grooves.

Warranty

MRC Bearing Services warrants that products sold by it shall be free from defects in material and workmanship. MRC Bearing Services' obligation under this warranty is expressly limited to furnishing without additional charge a replacement, or at its option, repairing or issuing credit for any product which shall within one year from the date of sale be returned freight prepaid to the plant designated by an MRC Bearing Services representative and which upon inspection is determined by MRC Bearing Services to be defective in materials or workmanship. Complete information as to service, mounting and relubrication should accompany any product returned for inspection. The provisions of this warranty shall not apply to any MRC Bearing Services product which has been subjected to misuse, improper mounting, assembly or lubrication; or which has been repaired or altered if such repair or alteration in the judgement of MRC Bearing Services would adversely affect performance of the product.

This warranty is in lieu of all other warranties, expressed or implied, including any limited warranty of merchantability or fitness for a particular purpose and is also in lieu of all other obligations or liabilities on the part of MRC Bearing Services, including any obligation or liability arising from contract, tort or otherwise for damages and in no event shall seller be liable hereunder or otherwise for loss of profits; special, incidental, or consequential damages of any kind. There are no warranties, expressed or implied, made by MRC Bearing Services, except the warranty against defects in material and workmanship set forth above. MRC Bearing Services and SKF USA Inc. neither assume nor authorize any other person or firm to assume for it any other obligation or liability in connection with its products.

METRIC RADIAL BEARINGS

EXAMPLE OF MARKING ON BEARING BOX

203SZ-0001 STEEL/C3/ABEC-1	R07
-------------------------------	-----

0001 = MRC INTERNAL SUFFIX CODE
R07 = DATE CODE

BEARING IDENTIFICATION CODE

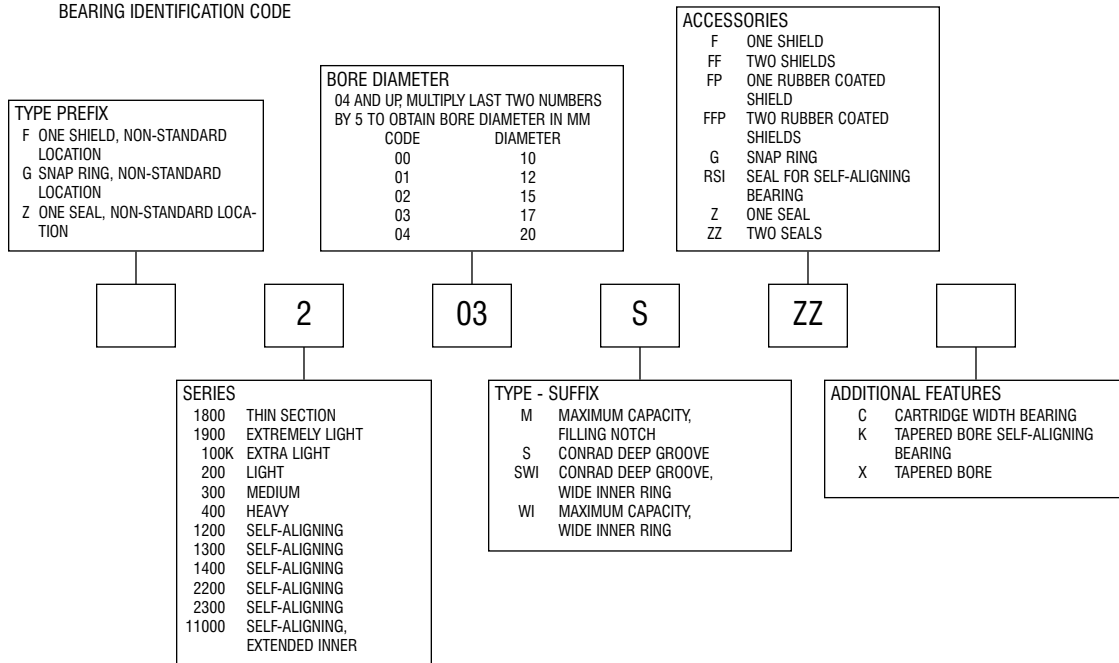

METRIC ANGULAR CONTACT BEARINGS







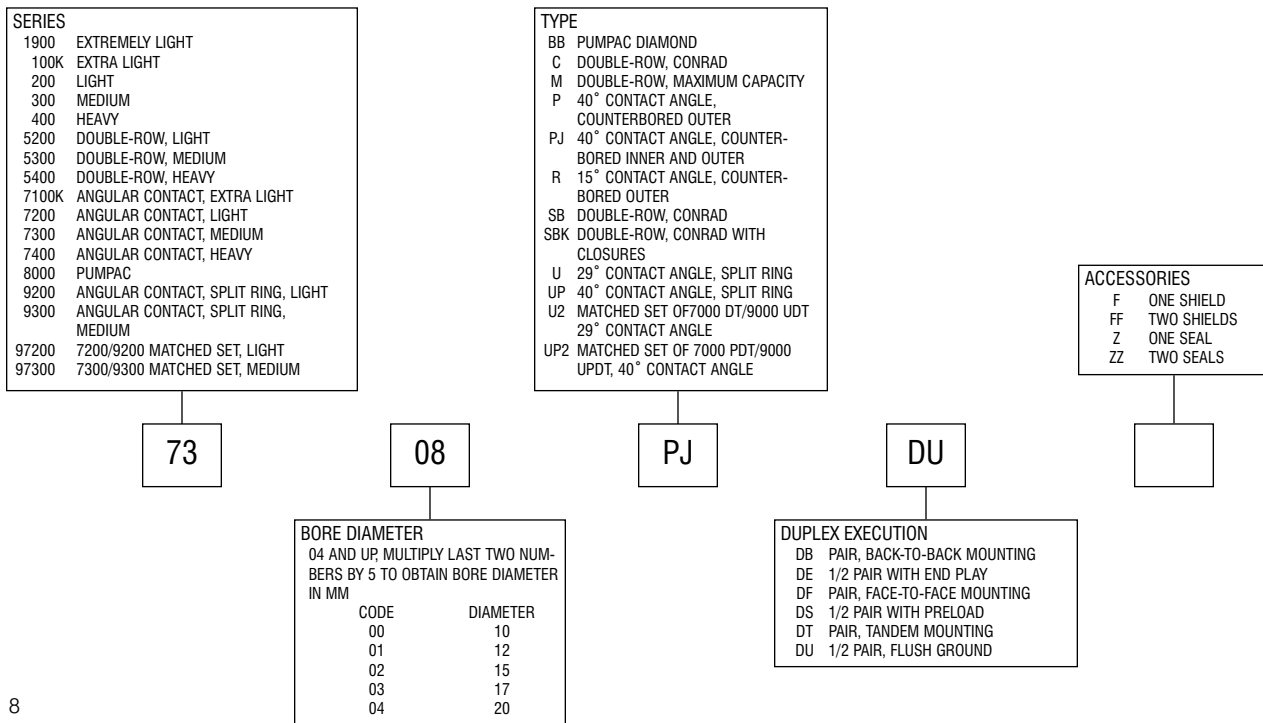

EXAMPLE OF MARKING ON BEARING BOX

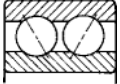
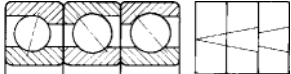
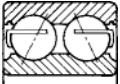
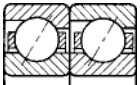
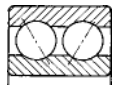

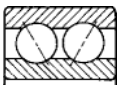

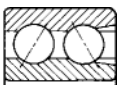

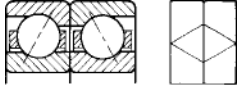

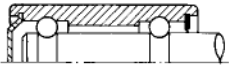

7308 PJDU - H501 PRESSED BRASS/ABEC-3	R07
--	-----



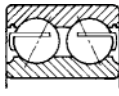
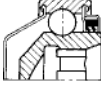

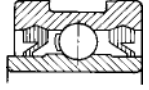
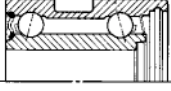
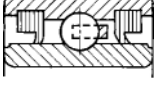



H501 = MRC INTERNAL SUFFIX CODE
R07 = DATE CODE

BEARING IDENTIFICATION CODE





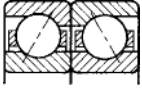

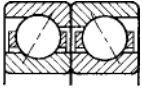
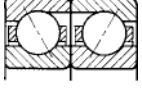
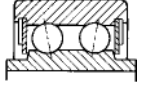
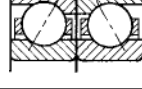
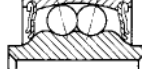



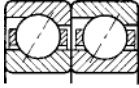

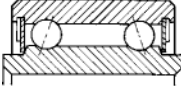
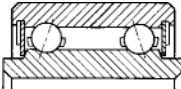

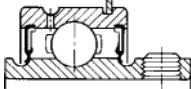
Prefix	Suffix	Description	Example	Illustration
	A	Double-row, angular contact, non-filling notch ball bearing with cast bronze finger type cage, inwardly convergent contact angles, non-rigid design.	5210A	
	AAB	A triplex set of PumPac® bearings. Two 40° contact angle bearings in tandem mounting matched back-to-back with one 15° contact angle bearing. "V" etched on O.D.	8309AAB	
	AC	Double-row angular contact, non-filling notch ball bearing, with outwardly convergent contact angles, rigid design and heavy duty cage.	5308AC	
	ADT	Two PumPac "A" Bearings in tandem		
	AH	Double-row angular contact, non-filling notch ball bearing, with cast iron bronze finger type cage, narrow width, inwardly convergent contact angles, non-rigid design.	5210AH	
	AN	Lock nut.	AN15	
	AS	Double-row, angular contact, non-filling notch ball bearing, with cast bronze finger type cage, and inwardly convergent contact angles, non-rigid design.	5210AS	
	B	Torque tube type airframe bearing.	B540	
	B	Thrust ball bearing with grooved races.	4B	
	B	Outwardly convergent contact angle when used with 5000 Series filling notch bearings. Rigid design.	5309B	
	B	Single-row, metric, high speed rotor ball bearing.	34B	
	BB	PumPac® Diamond. Matched set of 15° contact angle bearings in back-to-back mounting. "V" etched on O.D. to form a diamond.	8309BB	
	BC	W Bell crank type airframe bearing.	BC4W10	
	BIC	ABMA designation, non-filling notch, inch size, various configurations.	18BIC4800	















Prefix	Suffix	Description	Example	Illustration
BTK		Double-row, integral shaft ball bearing, with seal and shield.	BTK4800	
BWF		Double-row, integral shaft ball bearing, with two seals.	BWF4800	
	C	Single-row deep groove type ball bearing, similar to S Type.	208C	
	C	Thrust ball bearing, single acting, with flat races.	6C	
	C	Double-row angular contact, non-filling notch ball bearing, with outwardly convergent contact angles, rigid design.	5310C	
CB		Conveyor type ball bearing.	CB5043	
	CF	Single-row deep groove type ball bearing, with one shield, similar to SF Type.	208CF	
	CFF	Single-row deep groove type ball bearing, with two shields, similar to SFF Type.	208CFF	
CONV	A	Conveyor bearing, two seals, slotted for bracket mounting.	CONV4A	
CONV	E	Double-row conveyor bearing, seal and shield, slotted for bracket mounting, Rigid design.	CONV4E2	
CONV	J	Conveyor bearing, two seals, direct roller mounting.	CONV4J	
CONV	SF	Conveyor bearing, seal and shield, slotted for bracket mounting.	CONV4SF	
CONV	SZ	Conveyor bearing, one seal, direct roller mounting.	CONV4SZ	
CONV	Y	Conveyor bearing, seal and shield, slotted for bracket mounting.	CONV3Y2	













Prefix	Suffix	Description	Example	Illustration
	CT	Clutch release bearing, plain.	211CT	
	CTC	Clutch release bearing, with housing.	210CTC	
	CTQ	Clutch release bearing, with housing.	211CTQ	
	CTR	Clutch release bearing, with housing and grease fitting.	209CTR	
	CZ	Single-row deep groove type ball bearing with one seal, similar to SZ Type.	208CZ	
	CZZ	Single-row deep groove type ball bearing with two seals, similar to SZZ Type.	208CZZ	
	D	A duplex ground half pair matched with a similar half pair in a DE, DS, DT or DU arrangement.	7207D	
	DB	Matched set of duplex bearings, back-to-back mounting.	7207DB	
	DD	Two glass fabric reinforced PTFE (Teflon®) seals.	B540DD	
	DE	Matched set of duplex bearings, universal mounting, with end play requirement.	7207DE	
	DF	Matched set of duplex bearings, face-to-face mounting.	7207DF	
	DPP	Double-row airframe bearing with two glass reinforced PTFE (Teflon®) seals, non rigid design.	DPP4	
	DS	Matched set of duplex bearings, universal mounting, with preload requirement.	7207 DS DL	
	DSP	Double-row, internally self-aligning, airframe bearing, with two glass reinforced PTFE (Teflon®) seals.	DSP4	



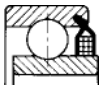

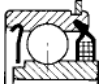
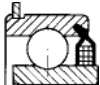
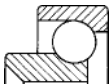







Teflon® is a registered trademark of E.I. duPont de Nemours & Co.



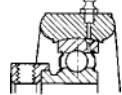



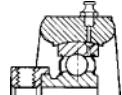
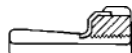



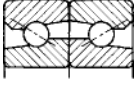
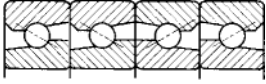

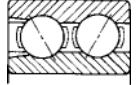
Prefix	Suffix	Description	Example	Illustration
	DT	Matched set of duplex bearings, tandem mounting.	7207 DT	
	DU	½ pair duplex bearings, universal mounting with no preload or end play.	7207 DU	
DW		Double-row airframe bearing with two glass reinforced PTFE (Teflon®) seals, rigid design.	DW4	
DW	K	Double-row airframe bearing with cage and two glass reinforced PTFE (Teflon®) seals, rigid design.	DW4K	
E		Single-row magneto type ball bearing with separable outer ring.	E16	
	E	Self-aligning ball bearing with higher load rating than original design.	2205E	
ER		Power transmission type bearing, extended inner ring with set screws, with snap ring and relube holes in outer ring.	ER16	
E	R	Single-row, counterbored outer ring, radial type ball bearing.	E16R1	
	ES	Single-row elevator type bearing with groove in outer ring and two shields.	203ES	
	F	Thrust bearing, single acting.	1115F	
	F	One shield.	207SF	
FB		Single-row flanged ball bearing with tapered O.D.	FB3	
FB	FFM	Single-row flanged ball bearing with tapered O.D. and two removable shields.	FB3FFM	
FB	FFP	Single-row flanged ball bearing with tapered O.D. and two rubber beaded shields.	FB3FFP	

Teflon® is a registered trademark of E.I. duPont de Nemours & Co.













Prefix	Suffix	Description	Example	Illustration
FB	ZZ	Single-row flanged ball bearing with tapered O.D. and two seals.	FB3ZZ	
FC		Single-row flanged ball bearing with cylindrical O.D.	FC3	
FC	FFM	Single-row flanged ball bearing with cylindrical O.D. and two removable shields.	FC3FFM	
FC	FFP	Single-row flanged ball bearing with cylindrical O.D. and two rubber beaded shields.	FC3FFP	
FC	ZZ	Single-row flanged ball bearing with cylindrical O.D. and two seals.	FC3ZZ	
	FF	Two shields.	207SFF	
	FFC	Single-row, inch size, cartridge width bearing with two shields.	R4FFC	
	FFM	Two removable shields.	R4FFM	
	FFMC	Single-row, inch size, cartridge width bearing with two removable shields	R4FFMC	
	FFP	Two rubber coated shields.	R4FFP	
	FFS	Two felt seals, replaced by 88XXX.	203FFS	
	FFSG	Two felt seals and snap ring, replaced by 488XXX.	203FFSG	
FG	M	Single-row maximum capacity ball bearing with shield on same side as filling notch and snap ring on opposite side.	FG309M	
FG	R	Single-row counterbored outer ring ball bearing with shield and snap ring on side opposite counterbore.	FG209R	

Prefix	Suffix	Description	Example	Illustration
	FM	One removable shield.	R4FM	
F	M	Single-row maximum capacity ball bearing with shield on same side as filling notch.	F309M	
F	MG	Single-row maximum capacity ball bearing with shield and snap ring on same side as filling notch.	F309MG	
	FP	One rubber coated shield.	R4FP	
F	R	Single-row counterbored outer ring ball bearing with shield on side opposite counterbore.	F209R	
F	RG	Single-row counterbored outer ring ball bearing with snap ring on counterbore side and shield on opposite side.	F209RG	
	FS	One felt seal, replaced by 8XXX.	203FS	
	FSF	One felt seal and one shield, replaced by 87XXX.	203FSF	
	FSFG	One felt seal and one shield with snap ring on seal side.	203FSFG	
	FSG	One felt seal with snap ring on open side of bearing.	209FSG	
	FW	Front wheel bearing.	41FW	
	FZ	One seal and one shield.	207SFZ	
FZG	M	Single-row maximum capacity ball bearing with seal on filling notch side and shield and snap ring on opposite side.	FZG209M	
FZ	M	Single-row maximum capacity ball bearing with seal on filling notch side and shield on opposite side.	FZ209M	

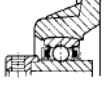

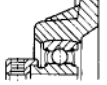



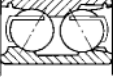







Prefix	Suffix	Description	Example	Illustration
FZ	MG	Single-row maximum capacity ball bearing with seal and snap ring on filling notch side and shield on opposite side.	FZ209MG	
	G	Snap ring.	208SG	
G	FS	One felt seal with snap ring on same side as seal.	G209FS	
G	FSF	One felt seal and one shield with snap ring on shield side, replaced by 487xxx, .	G209FSF	
G	MF	Single-row maximum capacity ball bearing with shield and snap ring on side opposite filling notch.	G207MF	
G	MFZ	Single-row maximum capacity ball bearing with shield on filling notch side and seal and snap ring on opposite side.	G207MFZ	
G	MS	Pressed flange housing, regreaseable, eccentric locking collar.	G62MS3	
GR		Pillow block, regreaseable, with two Flexigard seals, eccentric locking collar.	GR2	
G	R	Single-row counterbored outer ring ball bearing with snap ring on side opposite counterbore. 15° contact angle.	G209R	
G	RF	Single-row counterbored outer ring ball bearing with shield on counterbore side and snap ring on opposite side. 15° contact angle.	G209RF	
G	SF	Single-row deep groove ball bearing with shield and snap ring on same side.	G208SF	
GT		Pillow block, regreaseable, with two seals, eccentric locking collar.	GT1½	
H		Adapter sleeve, nut and lockwasher assembly used with self-aligning ball bearing with tapered bore.	H322	
	H	9000 Series angular contact ball bearing with split outer ring	9310H	









Prefix	Suffix	Description	Example	Illustration
HH		Combined glass reinforced PTFE (Teflon®) seal and stainless steel shield.	HH-KSP8	
J	DF	Ball screw support, duplex pair, face-to-face mounting.	J150DF	
J	DFDT	Ball screw support, quadruplex set, tandem pair matched face-to-face with a tandem pair.	J150DFDT	
	JR	Single-row, counterbored outer ring, radial type bearing, reduced O.D. and narrow width. 15° contact angle.	114JR	
	K	Double-row angular contact, filling notch type bearing, standard width and inwardly converging contact angles, non-rigid design.	5210K	
	K	Self-aligning ball bearing with 1:12 tapered bore.	1215K	
K	L	Single-row airframe type bearing with two stainless steel shields.	K3L	
KP		Single-row airframe type bearing with two glass reinforced PTFE (Teflon®) seals.	KP3	
KP	A	Single-row airframe type bearing with two glass reinforced PTFE (Teflon®) seals, similar to KP Type except reduced O.D. and width.	KP3A	
KP	AK	Single-row airframe type bearing with two glass reinforced PTFE (Teflon®) seals, and cage, same as KP-A except includes cage.	KP3AK	
KP	B	Single-row airframe type bearing with two glass reinforced PTFE (Teflon®) seals.	KP16B	
KP	BS	Single-row airframe type bearing with two glass reinforced PTFE (Teflon®) seals, and self-aligning ring in O.D.	KP16BS	
KP	K	Single-row airframe type bearing with two glass reinforced PTFE (Teflon®) seals, and cage.	KP4K	
	KR	Single-row, counterbored outer ring, radial type, ball bearing. 15° contact angle.	104KR	

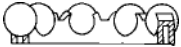

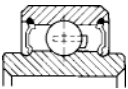

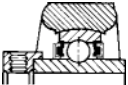
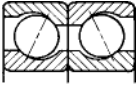
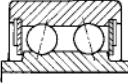

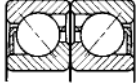
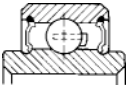
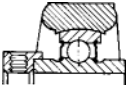

Teflon® is a registered trademark of E.I. duPont de Nemours & Co.

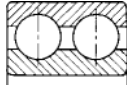

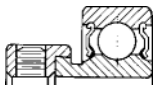
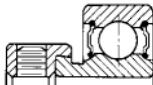
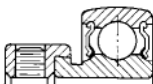
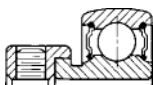
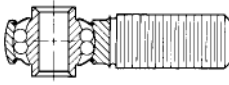



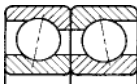

Prefix	Suffix	Description	Example	Illustration
	KS	Single-row deep groove type ball bearing.	104KS	
	KSB	Single-row, extra precision, separable inner ring, radial type bearing.	106KSB	
	KSJ	Single-row, extra precision, low shoulder one side of inner, non-separable, radial type bearing.	106KSJ	
KSP		Single-row, airframe type bearing, internally self-aligning, with two glass reinforced PTFE (Teflon®) seals.	KSP4	
KSP	A	Single-row, airframe type bearing, internally self-aligning, with two glass reinforced PTFE (Teflon®) seals. Similar to KSP except reduced O.D. and width.	KSP4A	
KSP	L	Single-row airframe type bearing, internally self-aligning, with two glass reinforced PTFE (Teflon®) seals. Similar to KSP except reduced O.D. and width.	KSP3L	
L		One glass reinforced PTFE (Teflon®) seal.	L105KS	
LB		Flange unit, non-regreaseable, with two labyrinth seals, and eccentric locking collar.	LB1	
LL		Two glass reinforced PTFE (Teflon®) seals.	LL105KS	
LZ		Flange unit, non-regreaseable, with two seals and eccentric locking collars.	LZ2	
M		Airframe bearing with special close tolerances.	MKP16B	
M		Single-row, miniature, inch size bearing, ABEC-5 precision.	M0620	
	M	Single-row, maximum capacity, filling notch type ball bearing.	208M	
	M	Double-row angular contact, filling notch ball bearing with outwardly convergent contact angles.	5210M	





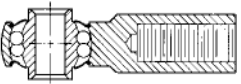
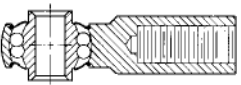
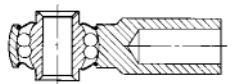
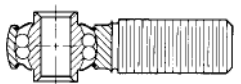
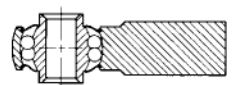



Teflon® is a registered trademark of E.I. duPont de Nemours & Co.



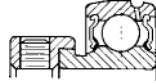
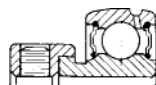
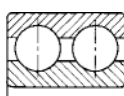

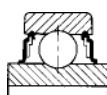

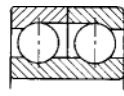
Prefix	Suffix	Description	Example	Illustration
	M	Machined bronze cage for self-aligning ball bearings.	2314M	
	MC2	Machined bronze cage and ABMA C2 internal clearance for self-aligning ball bearing.	2315MC2	
	MFZG	Single-row maximum capacity, filling notch ball bearing with shield and snap ring on filling notch side and seal on opposite side.	209MFZG	
MR	C	Cylindrical roller bearing, with two flanges on inner ring, none on outer ring.	MR208C	
MR	CQ	Cylindrical roller bearing, outer ring only, no flanges.	MR208CQ	
MR	CY	Cylindrical roller bearing, inner ring, roller and cage assembly only, two flanges on inner ring.	MR208CY	
MR	D	Cylindrical roller bearing, with two flanges on inner ring, one on outer ring.	MR208D	
MR	E	Cylindrical roller bearing, two flanges on outer ring, none on inner ring.	MR208E	
MR	EJ	Cylindrical roller bearing, inner ring only, no flanges.	MR208EJ	
MR	EX	Cylindrical roller bearing, outer ring, roller and cage assembly only, two flanges on outer ring.	MR208EX	
MR	F	Cylindrical roller bearing, two flanges on outer ring, one flange on inner ring, with side plate.	MR208F	
MR	G	Cylindrical roller bearing, two flanges on outer ring, one flange on inner ring.	MR208G	
	MW	Double-row angular contact, filling notch ball bearing with inwardly convergent contact angles.	5210MW	
N		Lock nut.	N06	

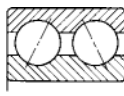
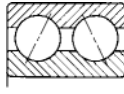

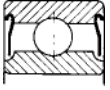
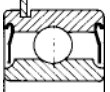

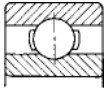
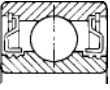



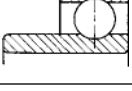
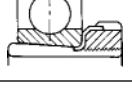
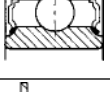
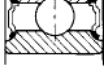

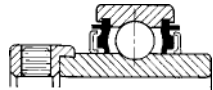
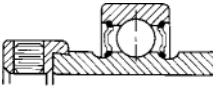
Prefix	Suffix	Description	Example	Illustration
	N	Single-row, maximum capacity, filling notch type ball bearing, narrow width.	112N	
	NYL	Fibreglass reinforced 6/6 polyamide cage.	206S-NYL	
O	B	Single-row, metric, high speed rotor bearing, less inner ring.	034B	
OR	B	Single-row, inch size, high speed rotor bearing, less inner ring.	OR4B	
P		Single-row airframe type bearing, two seals, aircraft pulley type.	P8	
	P	Single-row angular contact, counterbored outer ring, heavy duty bearing, with 40° contact angle.	7308P	
PB		Pillow block, non-regreaseable, with two labyrinth seals and eccentric locking collar.	PB1⁷/₁₆	
	PD	A duplex ground half pair, 40° angular contact bearing, counterbored outer ring, matched with a similar half pair in a DE, DS, DT, or DU arrangement.	7308PD	
PD	K	Double-row airframe type bearing, two seals, aircraft pulley type, rigid design.	PD5K	
	PJ	Single-row angular contact, counterbored inner and outer ring, heavy duty bearing, with a 40° contact angle.	7308PJ	
	PJD	A duplex ground half pair, 40° angular contact bearing, counterbored inner and outer rings, matched with a similar half pair in a DE, DS, DT, or DU arrangement.	7308PJD	
P	K	Single-row airframe type bearing, with two seals, aircraft pulley type.	P5K	
PZ		Pillow block, non-regreaseable, with two seals and eccentric locking collar.	PZ2⁷/₁₆	
R		Single-row, small inch size bearing.	R6	

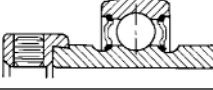

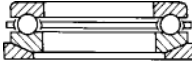



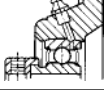
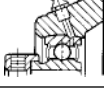

Prefix	Suffix	Description	Example	Illustration
	R	Single-row, counterbored outer ring, radial type bearing, 15° contact angle.	207R	
	R	Double-row, radial type, non-filling notch ball bearing with cast bronze finger type cage. 0° contact angles.	5306R	
R	A	Single-row, small inch size bearing, with increased O.D. and width.	R4A	
RA	ATT	Power transmission type, inner extended one side only, cylindrical O.D., two flexigard seals, non-regreaseable, eccentric locking collar.	RA008ATT	
RA	AZZ	Power transmission type, inner extended one side only, cylindrical O.D., two seals, non-regreaseable, eccentric locking collar.	RA008AZZ	
RA	BTT	Power transmission type, inner ring extended one side only, spherical O.D., two Flexigard seals, non-regreaseable, eccentric locking collar.	RA008BTT	
RA	BZZ	Power transmission type, inner ring extended one side only, spherical O.D., two seals, non-regreaseable, eccentric locking collar.	RA008BZZ	
RAP	M	Airframe bearing, rod end type, with male threaded shank.	RAP3M	
R	B	Single-row, small inch size, high speed rotor bearing, with separable inner ring.	R3B	
R	C	Cylindrical roller bearing, with two flanges on inner ring, none on outer ring.	R208C	
R	CQ	Cylindrical roller bearing, outer ring only, no flanges.	R208CQ	
R	CY	Cylindrical roller bearing, inner ring, roller and cage assembly only, two flanges on inner ring.	R208CY	
R	D	Cylindrical roller bearing, with two flanges on inner ring, one on outer ring.	R208D	
	RD	Single-row, counterbored outer ring, radial type bearing, with controlled relationship of ring faces, used in duplex sets.	306RD	

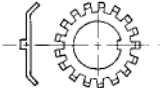
Prefix	Suffix	Description	Example	Illustration
	RDM	Dynamometer bearing, ABEC-5 inner ring, ABEC-1 outer ring, phenolic cage, 15° contact angle.	316RDM	
	RDT	Single-row, split inner ring bearing, 20° contact angle.	309RDT1½	
R	E	Cylindrical roller bearing, two flanges on outer ring, none on inner ring.	R208E	
R	EJ	Cylindrical roller bearing, inner ring only, no flanges.	R208EJ	
R	EX	Cylindrical roller bearing, outer ring, roller and cage assembly only, two flanges on outer ring.	R208EX	
REP	N	Airframe bearing, rod end type, with female threaded shank.	REP3N	
REP	F	Airframe bearing, rod end type, with female threaded shank.	REP4F7	
REP	H	Airframe bearing, rod end type, with hollow shank.	REP3H5	
REP	M	Airframe bearing, rod end type, with male threaded shank.	REP4M6	
REP	S	Airframe bearing, rod end type, with solid shank.	REP4S10	
R	F	Cylindrical roller bearing, two flanges on outer ring, one flange on inner ring, with side plate.	R208F	
	RF	Single-row, counterbored outer ring, radial type bearing, with shield on counterbored side, 15° contact angle.	208RF	
	RFG	Single-row, counterbored outer ring, radial type bearing, with shield and snap ring on counterbored side, 15° contact angle.	208RFG	
R	G	Cylindrical roller bearing, two flanges on outer ring, one flange on inner ring.	R208G	

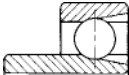
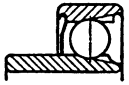
Prefix	Suffix	Description	Example	Illustration
	RG	Single-row, counterbored outer ring, radial type bearing, with snap ring on counterbored side, 15° contact angle.	208RG	
	RJ	Single-row, counterbored inner and outer rings, extra precision, radial type bearing, 15° contact angle.	106RJ	
RRA	BTT	Power transmission bearing, inner ring extended one side only, spherical O.D., two Flexigard seals, regreaseable, eccentric locking collar.	RRA008BTT	
RRA	BZZ	Power transmission bearing, inner ring extended one side only, spherical O.D., two seals, regreaseable, eccentric locking collar.	RRA008BZZ	
	RS	Double-row, radial type, non-filling notch ball bearing, with cast bronze finger type cage.	5312RS	
	2RS1	Self-aligning ball bearing with two synthetic rubber seals.	22102RS1	
RT		Power transmission bearing, inner ring extended both sides, two seals, regreaseable, eccentric locking collar.	RT107BZZ	
RW		Single-row deep groove, rear wheel type bearing with two seals.	RW716	
	RZ	Single-row, counterbored outer ring, radial type bearing, with seal on counterbored side, 15° contact angle.	306RZ	
	R2	Double-row, split outer ring, radial type bearing.	5206R2	
	S	Single-row deep groove ball bearing.	207S	
	S	9000 Series angular contact angle bearing with one-piece inner and outer rings, 20° contact angle.	9212S1	
	SB	Double-row, angular contact, non-filling notch bearing, with outwardly convergent contact angles, rigid design.	5203SB	
	SBK	Double-row, angular contact, non-filling notch, standard width bearing, with outwardly convergent contact angles, rigid design.	5203SBK	

Prefix	Suffix	Description	Example	Illustration
	SFFC	Single-row deep groove, cartridge width bearing, with two shields.	210SFFC	
	SFFCG	Single-row deep groove, cartridge width bearing, with two shields and snap ring.	210SFFCG	
	SFFP	Single-row deep groove ball bearing with two rubber beaded shields.	1910SFFP	
	SFP	Single-row deep groove ball bearing with rubber beaded shield.	1806SFP	
	SH	Single-row deep groove bearing, wider than standard.	105SH	
	SLLC	Single-row deep groove, cartridge width bearing, with two removable shields.	210SLLC	
	SRRC	Single-row deep groove, cartridge width bearing, with two labyrinth seals.	210SRRC	
S	S	Single-row, small inch size bearing.	S3S	
	ST	Stainless steel (440C) rings and rolling elements.	207SST	
	SV	Single-row deep groove bearing, narrower than standard.	209SV	
	SWI	Single-row deep groove bearing, with inner ring extended one side.	311SWI	
	SXY	Single-row deep groove bearing, tapered bore, with adapter sleeve and nut.	210SXY	
	SZZC	Single-row deep groove bearing, cartridge width, with two seals.	210SZZC	
	SZZCG	Single-row deep groove bearing, cartridge width, with two seals and snap ring.	210SZZCG	

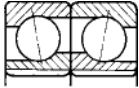
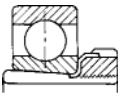
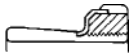
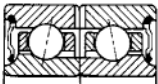
Prefix	Suffix	Description	Example	Illustration
T	ARR	Power transmission bearing, inner ring extended both sides, cylindrical O.D., two labyrinth seals, non-regreaseable, eccentric locking collar.	T1100ARR	
T	AZZ	Power transmission bearing, inner ring extended both sides, cylindrical O.D., two seals, non-regreaseable, eccentric locking collar.	T1100AZZ	
T	BRR	Power transmission bearing, inner ring extended both sides, spherical O.D., two labyrinth seals, non-regreaseable, eccentric locking collar.	T1100BRR	
T	BZZ	Power transmission bearing, inner ring extended both sides, spherical O.D., two seals, non-regreaseable, eccentric locking collar.	T1100BZZ	
	TT	Two metal shrouded synthetic rubber seals.	205STT	
	U	Thrust bearing, single acting, with self-aligning washer.	1109U	
	U	9000 Series angular contact ball bearing with split inner ring, 29° contact angle.	9309U	
	UH	9000 Series angular contact ball bearing with split inner and outer rings, 29° contact angle.	9213UH	
	UK	9000 Series, extra light, angular contact ball bearing with split inner ring, 29° contact angle.	9107UK	
	UP	9000 Series, 40° angular contact ball bearing with split inner ring.	9308UP	
UR		Flange unit, two seals, regreaseable, with eccentric locking collar.	UR2	
UT		Flange unit, two Flexigard seals, regreaseable, with eccentric locking collar.	UT1½	
	V	Single-row, maximum capacity, filling notch type ball bearing, with narrow width.	209V	
	V	Felt seal replacement bearing with one seal and one shield with snap ring on seal side.	487508V	

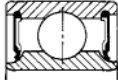

























Prefix	Suffix	Description	Example	Illustration
W		Lock washer.	W06	
	W	Cylindrical roller bearing, roller and cage assembly only.	R207W	
WC		Single-row felt seal replacement bearing with inner and outer ring faces flush on one side.	WC87504	
	WI	Single-row, maximum capacity, filling notch type ball bearing, with inner ring extended one side only.	318WI	
	WIF	Single row maximum capacity ball bearing with inner ring extended one side, and shield on extended inner side.	318WIF	
	X	Tapered bore bearing.	206SX	
XLR		Cylindrical roller bearing, inch size.	XLR3½E	
XLS		Single-row, counterbored outer ring, radial type ball bearing, inch size.	XLS2	
XO	RBDS	Excello Replacement Bearing.	XO90RBDS	
	XY	Tapered bore bearing with adapter sleeve.	208SXY	
	Y	Adapter sleeve and nut.	6Y	
Y	PWI-DB	Duplex pair of airframe bearings, seals on outboard side, aircraft pulley type.	Y96PWID2B	
	Z	One synthetic rubber seal.	206SZ	
	ZZ	Two synthetic rubber seals.	206SZZ	
	ZZC	Single-row, cartridge width bearing, extra small size, with two synthetic rubber seals.	38ZZC	

**Prefix/Suffix Symbols for Single-Row
Bearing Non-Standard Variants**

Nomenclature

- S**—Single Row Deep Groove Type
- M**—Single Row Filling Notch Type
- R**—15 Degree Angular Contact Type
- WI**—Wide Inner Ring Filling Notch Type
- SWI**—Wide Inner Ring Non-Filling Notch Type
- F**—Shield
- Z**—Seal
- G**—Snap Ring
- FS**—Felt Seal
- X**—Tapered Bore

When single seal is used, seal symbol (Z) replaces (F) in designations shown except for Filling Notch (M) Type

Prefix-Suffix	Illustration	Prefix-Suffix	Illustration	Prefix-Suffix	Illustration
MF		X-M		G-MFZ	
MG		MXF		FZG-M	
MFG		X-MF		MXFZ	
G-M		MFX		XFZ-M	
F-M		F-MX		X-MFZ	
F-MG		MFZ		FZ-MX	
G-MF		FZ-M		SFG	
FG-M		MFZG		G-SF	
MX		FZ-MG		SFX	

Nomenclature

S—Single Row Deep Groove Type

M—Single Row Filling Notch Type

R—15 Degree Angular Contact Type

WI—Wide Inner Ring Filling Notch Type

SWI—Wide Inner Ring Non-Filling Notch Type

F—Shield

Z—Seal

G—Snap Ring

FS—Felt Seal

X—Tapered Bore



When single seal is used, seal symbol (Z) replaces (F) in designations shown except for Filling Notch (M) Type

Prefix-Suffix	Illustration	Prefix-Suffix	Illustration	Prefix-Suffix	Illustration
SXF		G-FSF		F-RG	
SWIF		RF		RX	
F-SWI		RG		X-R	
WIF		RFG		RFX	
F-WI		F-R		X-RF	
FSG		G-R		F-RX	
G-FS		FG-R		FX-R	
FSFG		G-RF			

**Prefix/Suffix Symbols for Double-Row
Bearing Non-Standard Variants**

Nomenclature

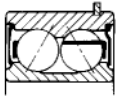
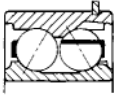
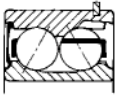
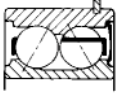
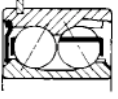
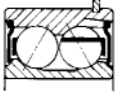
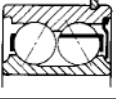
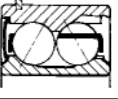
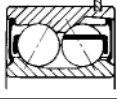
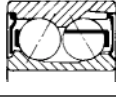
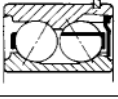
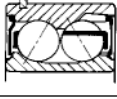
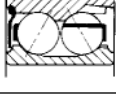
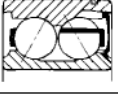
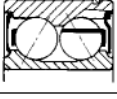
- M**—Filling Notch Type
- C**—Non-Filling Notch Type
- F**—Shield
- Z**—Seal
- G**—Snap Ring

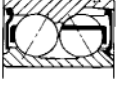
Prefix-Suffix	Illustration	Prefix-Suffix	Illustration	Prefix-Suffix	Illustration
G-CFZ		G-M		ZG-M	
G-CZ		F-MG		G-MFF	
G-CF		Z-MG		G-MZZ	
F-MZ		G-MF		F-MZG	
F-M		G-MZ		G-MFZ	
Z-M		FG-M		FG-MZ	

MRC Manufacturing Suffixes

The manufacturing suffix is specified on packing lists, invoices and all unit cartons. Whenever possible the manufacturing suffix is also shown on the bearing steel. It is separated from the standard MRC part number by several spaces. Example:

204SZZ

Standard MRC Part No.

H501

Manufacturing Suffix

A four digit manufacturing suffix is used by MRC internally to define bearing specifications as well as to track such information as plant-of-manufacture as product is distributed throughout the MRC warehousing network. This suffix is assigned sequentially within the MRC computer system and can only be cross-referenced internally by the MRC Customer Service Representative.

The standard MRC part number is sufficient for specifying customer requirements for all "Stock" sizes. The use of a non-descriptive manufacturing suffix permits minor changes to the design and manufacture of standard product without a confusing nomenclature change. The revised product may still be tracked through distribution by the four digit manufacturing suffix.

MRC Descriptive Part Suffixes

A Descriptive Part Suffix is frequently combined with the standard MRC Part Number to provide a more complete description of Bearing Design Specifications. Descriptive Suffixes are found on MRC Price Sheets, Packing Lists and Invoices. Preload and Endplay Descriptive Suffixes are only displayed on the bearing steel away from the basic part number.



Descriptive Part Suffixes are physically separated from the standard MRC Part Number by a dash “-”.

Descriptive Part Suffix Definitions

BKE	Machined Phenolic Composition (Bakelite)
BRS	Pressed Brass Cage
BRZ	Machined Bronze Cage
CA	Less than Normal End Play Designation for Duplexed Bearings
CB	Normal End Play Designation for Duplexed Bearings
CC	Greater than Normal End Play Designation for Duplexed Bearings
CX	Special End Play Designation for Duplexed Bearings
CO	ABMA #0 Radial Clearance (MRC-ST Fit)
C2	ABMA #2 Radial Clearance (MRC-TI Fit)
C3	ABMA #3 Radial Clearance (MRC-LO Fit)
C4	ABMA #4 Radial Clearance (MRC-XL Fit)
DE	End Play Designation for Duplexed Bearings
DL	Light Preload Designation for Duplexed Bearings
DM	Medium Preload Designation for Duplexed Bearings
DH	Heavy Preload Designation for Duplexed Bearings
DX	Special Preload Designation for Duplexed Bearings
EA	Each, Sold as ½ Pair (Example: 9218UDT-BRZEA)
HT	High Temperature Heat Treat
M	Machined Brass Cage for Self-Aligning Ball Bearing
RB	Texaco Premium RB Grease
# 3	ABEC-3 Tolerances
# 5	ABEC-5 Tolerances
# 7	ABEC-7 Tolerances
EMQ	Electric Motor Quality
NYL	Glass Fiber Reinforced Polyamide
PO	Poly-Oil Treatment
STL	Steel Cage
TDC	Thin Dense Chrome Plated
TN9	Glass Fiber Reinforced Polyamide Cage
T44	MRC Code #44 Radial Clearance

The six primary features of the services provided to our customers are listed below:

- MRC is always one **1-800-MRC-7000** phone call away—saving time in response to your customer.
- Fax number toll-free at 888-322-4672
-or-
(215) 513-4737
- Immediate attention is given to technical questions by our in-house engineering department.
- MRC Technical Services experts are able to address bearing problems in the field and offer solutions.
- MRC provides bearing failure analysis in problem applications.
- Friendly, knowledgeable customer service people are able to take important action on your requests.
- Many servicing warehouses assure inventory accessibility in all parts of the country.

NOTES

NOTES

NOTES

NOTES

NOTES

*Bearing
Specification
Tables*



<i>Table of Contents</i>	<i>Page</i>
MRC Bearing Series	39
Ball Bearing Variations.	40
Single-row deep groove, type S	43
Single-row deep groove cartridge type SFFC	53
Single-row maximum capacity, filling notch, type M.	57
Single-row 15 degree angular contact, type R.	65
Single-row 15 degree angular contact, type XLS	76
Single-row 29 degree angular contact, 7000 series	83
Single-row 40 degree angular contact, 7000 P series	97
Single-row 40 degree angular contact, 7000 PJ series	109
Single-row 29 degree angular contact, split ring, 9000 U series.	119
Single-row 40 degree angular contact, split ring, 9000 UP series	119
Duplex 29 degree angular contact 97000 U series	129
Duplex 40 degree angular contact 97000UP series	129
Double-row angular contact, 5000 series.	139
Self-aligning ball bearings	157
PumPac 8000, 8000 BB and 8000 AAB series.	175
Precision ABEC-5 and ABEC-7 bearings.	185
Single-row 15 degree angular contact, type R.	186
Single-row deep groove, type S, Woodworking Bearings	194
Excello bearings	197
Ball bearing supports	195
Specialty bearings.	201
Adapter type	202
Conveyor roll.	203
Dynamometer	205
Electric motor quality	209
Felt seal replacement	224
Mast guide	229
Wide inner ring	233

NOTES

The basic types of bearings shown on the following pages are furnished in several "series" as illustrated in the sketch. Note that although the bore is the same, the outside diameter, width and ball size are progressively larger from "thin section" to "heavy." Reference to the dimensions tables will indicate the series available for the different types.

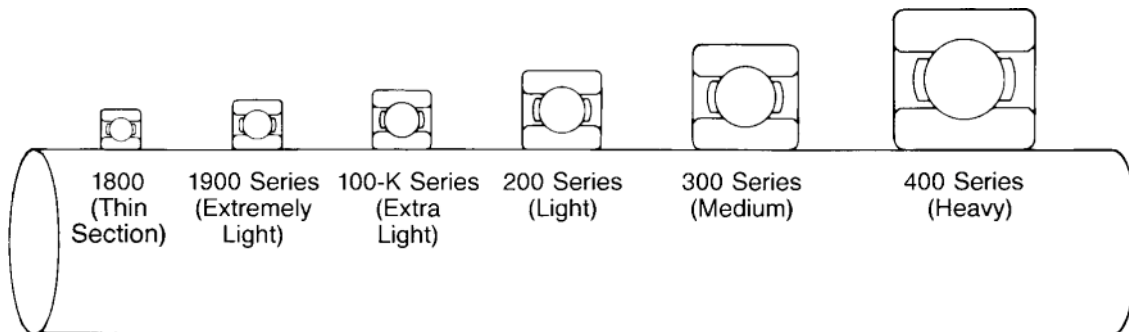

Ball Bearing Variations

MRC Bearing Services

The basic ball bearing types covered in this catalog are shown below. Special purpose bearings such as adapter type, mast guide, cartridge, conveyor, and felt seal are variations of these basic types.

The cross section of each bearing type shows bearing construction and contact angles, the angle at which the ball contacts the inner and outer ring ball grooves.

The vertical bar graphs indicate the relative radial load-carrying capacities and the horizontal bars show the relative thrust-carrying capacities of the bearing type in both directions. The blue bars represent the basic S type bearing. Black bars represent the other bearing types pictured above them. Showing them side by side provides a visual comparison of the relative capacities of each.

Bearing Type	Description	Load Capacity	Relative Capacity
Type S Conrad Deep Groove	Ordinarily supplied with loose internal clearance. Other degrees of internal clearance may be necessary for special conditions. Outer and inner races have full depth both sides. Balls assembled by eccentric displacement of rings.	Recommended for moderate to heavy radial loads, thrust load in either direction, or combined radial and thrust loads.	
Type M Maximum Capacity Filling Notch	Ordinarily supplied with normal internal clearance, other degrees of internal clearance may be necessary for special conditions. Has a filling notch on one side of inner and outer rings to allow assembly of maximum number of balls.	Can carry greater radial load than type S and greater combined radial and thrust load where radial load predominates. Recommended for heavily loaded bearing positions—heavy industrial machinery, farm equipment, tractors and trucks.	
Type R Angular Contact Counterbored Outer Ring	Ordinarily supplied with loose internal clearance, other degrees of internal clearance may be necessary for special conditions. To assemble full quota of balls, outer ring is expanded by heating. Bearing is non-separable.	Higher radial load carrying capacity than type S. Heavy thrust load in one direction only, or combined loads where a radial load predominates and thrust is always against heavy shoulder of outer ring.	
7000 Series Angular Contact Counterbored Outer Ring	Counterbored outer ring, non-separable, with a 29° contact angle. Two-piece pressed steel cage for normal use or one piece phenolic or solid bronze cage for high speed, high operating temperature, or severe vibration.	Can carry very high thrust load in one direction or combined radial and thrust load where thrust load predominates.	
7000 P Series Angular Contact Counterbored Outer Ring Heavy Duty	Similar in design to 7000 series except 40° contact angle, with ball complement and race depths designed for increased thrust capacity. Usually supplied with one-piece solid bronze or phenolic cage.	Thrust capacity is significantly greater than 7000 series. Restricted to primarily thrust load. Should not be used for radial load only or combined radial and thrust loads where radial load is predominate.	
7000 PJ Series Angular Contact Counterbored Inner and Outer Rings	Similar to 7000 P series except counterbored inner and outer rings, a one-piece pressed brass cage, and ABEC-3 bore tolerance.	Load capability same as 7000 P. Construction allows good oil flow through bearing. Closer bore tolerance provides closer control of interference fit on shaft.	

Bearing Type	Description	Load Capacity	Relative Capacity
9000 U Series Angular Contact Split Inner Ring	Designed with solid one-piece outer ring and two-piece inner ring, 29° contact angle, maximum ball complement and one-piece machined bronze cage.	Can carry very high thrust load in both directions or combined radial and thrust loads where thrust load is predominate. Should not be used for radial load only.	
9000UP Series Angular Contact Split Inner Ring Heavy Duty	Designed with solid one-piece outer ring and two-piece inner ring, 40° contact angle, maximum ball complement and one-piece machined bronze cage.	Greater thrust capacity than 9000U in both directions. Can carry combined radial and thrust loads where thrust load is predominate. Should not be used for radial load only.	
5000 Series Double-Row C and SB Type Conrad M Type Maximum Capacity	C and SB types assembled by elastic displacement of rings. Does not have filling notches. M type has filling notches on one row only for inserting full quota of balls. Supplied with loose internal clearance. Other clearances available if required.	C and SB types can carry heavy radial loads, heavy thrust loads in either direction, and heavy combined radial and thrust loads. M type has very heavy radial capacity and very heavy thrust capacity in one direction, with light reversing thrust capacity.	
8000 Series PumPac	Duplex pair, universally ground (DU), consisting of one 7000 P, 40° contact angle bearing with special internal construction, matched with one R type, 15° contact angle bearing, both having a one piece machined bronze cage. Usually mounted back-to-back (DB) with Apex of "V" etched on O.D. pointing in direction of major thrust load.	Can carry very heavy thrust load in one direction and moderate reversing thrust load. Minimizes skidding in unloaded, or inactive bearing and provides very good radial and axial rigidity. Used mainly in large vertical pumps and motors.	
Self-Aligning Ball Bearing	Double-row ball bearing with individual raceways in inner ring and a common sphered raceway in the outer ring, which gives the bearing its self-aligning ability. Usually furnished with normal radial clearance, and a glass reinforced polyamide cage with options of pressed steel and machined brass in some sizes.	Used in a wide variety of applications and is particularly suitable where misalignment can arise from errors in mounting or shaft deflection, recommended for radial load or combined radial and thrust loads where the thrust load is extremely light.	

NOTES

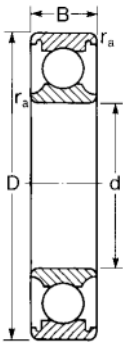

The MRC conrad ball bearing is a single-row radial deep groove bearing with no filling notches. It can carry significant radial loads, and, because of the uninterrupted raceway grooves and the high degree of conformity between balls and raceways, it can carry substantial thrust loads in either direction, even at very high speeds. Single-row deep groove ball bearings are offered open or with single or double shields or seals, as well as with snap rings in various combinations.

Cage Types and Materials

This type of bearing is supplied with a pressed steel cage as standard; however, for special requirements, it can be supplied with a two-piece riveted machined cage of phenolic composition or bronze material.

Size	Series	Page
30	Extra Small	44
R	Small Inch-Size	45
1800S	Thin Section	46
1900S	Extremely Light	47
100S	Narrow-Type Light	48
100KS	Extra Light	49
200S	Light	50
300S	Medium	51
400S	Heavy	52
Cartridge Type		53
Equivalent Load and Life		54
Life Calculation Examples		55

30 Series

Extra Small Size

MRC Bearing Services

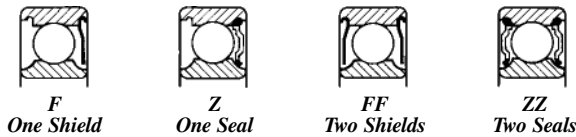
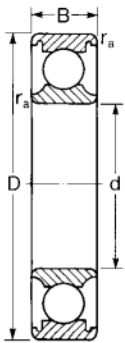

These single-row radial conrad-type bearings have 4 mm to 9 mm bores (approximately $\frac{5}{32}$ " to $\frac{3}{8}$ "), and are designed for very small shafts. They are suitable for high speed fractional horsepower motors and small turbines. MRC offers open, shielded, and sealed types. Some sizes are available in stainless steel. 30 Series supplied with ABMA CO radial clearance unless otherwise specified.

MRC Bearing Number	Bore		Outside Diameter		Width		Fillet Radius ¹⁾		ZD ²⁾		Basic Radial Load Rating				Speed Rating ²⁾		
	d	in	D	in	B	in	r _a	in	mm	in	Dynamic C ³⁾		Static C ₀		Open and Shielded Grease		Single and Double Sealed Grease
											N	lbf	N	lbf	RPM	RPM	RPM
34	4	.1575	16	.6299	5	.1969	.30	.012	45	.07	1 470	330	600	135	43 000	50 000	30 000
35	5	.1969	19	.7480	6	.2362	.30	.012	96	.15	2 210	497	950	214	36 000	43 000	26 000
36	6	.2362	19	.7480	6	.2362	.30	.012	96	.15	2 210	497	950	214	36 000	43 000	26 000
37	7	.2756	22	.8661	7	.2756	.30	.012	110	.17	3 250	731	1 360	306	36 000	43 000	23 000
38	8	.3150	22	.8661	7	.2756	.30	.012	110	.17	3 250	731	1 360	306	36 000	43 000	23 000
39	9	.3543	26	1.0236	8	.3150	.64	.025	161	.25	4 620	1 040	1 960	441	28 000	34 000	20 000

¹⁾ Fillet radius indicates maximum fillet radius on shaft or in housing which bearing corner will clear.

²⁾ Listed values are for pressed steel or polyamide cage, ABEC-1.

For phenolic composition cage, multiply by 1.66 for grease and 2.00 for oil. For machined bronze cage, multiply by 1.25 for grease and 1.50 for oil. For phenolic composition cage, ABEC-5 or 7, multiply by 2.30 for grease and 2.80 for oil. The speed rating adjustment factors have been determined through historical application and practice. For a more complete explanation, see page 276.

³⁾ Rating for one million revolutions or 500 hours at 33 $\frac{1}{3}$ RPM.

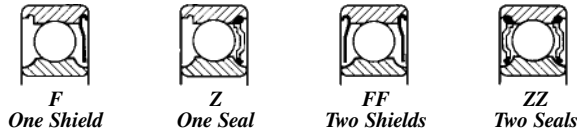
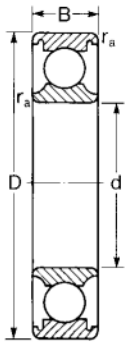

R series bearings are single-row radial conrad-type bearings that are available in inch sizes for shafts from 1/8" to 1 1/2" in diameter. Open, shielded, and sealed types are available, and many sizes are available in stainless steel.

R Series supplied with ABMA CO radial clearance unless otherwise specified.

MRC Bearing Number	Bore d		Outside Diameter D		Width B Plain		Shielded or Sealed		Fillet Radius ¹⁾ r _a		ZD ²⁾		Basic Radial Load Rating				Speed Rating ²⁾		
													Dynamic C ³⁾		Static C ₀		Open and Shielded Grease		Shielded Oil
	mm	in	mm	in	mm	in	mm	in	mm	in	mm	in	N	lbf	N	lbf	RPM	RPM	RPM
R-2	3.2	.1250	9.5	.3750	4.0	.1562	4.0	.1562	.30	.012	19	.03	312	70	120	27	75 000	91 000	52 000
R-2-A	3.2	.1250	12.7	.5000	4.4	.1719	4.4	.1719	.30	.012	19	.03	312	70	120	27	75 000	91 000	52 000
R-3	4.8	.1875	12.7	.5000	4.0	.1562	5.0	.1960	.30	.012	39	.06	956	215	490	110	57 000	69 000	40 000
R-4	6.4	.2500	15.9	.6250	5.0	.1960	5.0	.1960	.30	.012	45	.07	1 480	332	620	139	44 000	54 000	31 000
R-4-A	6.4	.2500	19.1	.7500	5.6	.2188	7.1	.2812	.41	.016	71	.11	2 810	632	1 160	261	39 000	48 000	27 000
R-6	9.5	.3750	22.2	.8750	5.6	.2188	7.1	.2812	.41	.016	110	.17	3 320	746	1 340	301	31 000	38 000	21 000
R-8	12.7	.5000	28.6	1.1250	6.4	.2500	7.9	.3125	.41	.016	181	.28	5 070	1 140	2 400	540	24 000	29 000	16 000
R-10	15.9	.6250	34.9	1.3750	7.1	.2812	8.7	.3438	.79	.031	226	.35	6 050	1 360	3 250	731	18 000	22 000	13 000
R-12	19.1	.7500	41.3	1.6250	7.9	.3125	11.1	.4375	.79	.031	361	.56	9 360	2 100	5 100	1 150	16 000	19 000	11 000
R-14	22.2	.8750	47.6	1.8750	9.5	.3750	12.7	.5000	.79	.031	406	.63	10 100	2 270	5 850	1 320	14 000	17 000	9 600
R-16	25.4	1.0000	50.8	2.0000	9.5	.3750	12.7	.5000	.79	.031	406	.63	10 100	2 270	6 000	1 350	13 000	16 000	9 000
R-18	28.6	1.1250	54.0	2.1250	9.5	.3750	12.7	.5000	.79	.031	510	.79	12 500	2 810	7 500	1 690	11 000	14 000	7 900
R-20	31.8	1.2500	57.2	2.2500	9.5	.3750	12.7	.5000	.79	.031	613	.95	14 000	3 150	9 300	2 090	11 000	13 000	7 500
R-24	38.1	1.5000	66.7	2.6250	11.1	.4375	14.3	.5625	.79	.031	755	1.17	16 800	3 780	11 800	2 650	9 000	11 000	6 200

¹⁾ Fillet radius indicates maximum fillet radius on shaft or in housing which bearing corner will clear.

²⁾ Listed values are for pressed steel or polyamide cage, ABEC-1.

For phenolic composition cage, multiply by 1.66 for grease and 2.00 for oil. For machined bronze cage, multiply by 1.25 for grease and 1.50 for oil. For phenolic composition cage, ABEC-5 or 7, multiply by 2.30 for grease and 2.80 for oil. The speed rating adjustment factors have been determined through historical application and practice. For a more complete explanation, see page 276.

³⁾ Rating for one million revolutions or 500 hours at 33 1/3 RPM.

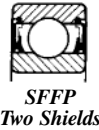
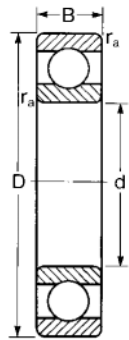

1800-S Series bearings are single-row radial conrad-type bearings that can accommodate light radial loads, two-directional thrust loads, or a combination of both. They are designed for applications where space or weight is very limited.

The 1800-S Series is supplied with an ABMA CO Radial internal clearance unless otherwise specified.

MRC Bearing Number	Bore		Outside Diameter		Width		Fillet Radius ¹⁾		Basic Radial Load Rating				Speed Rating ²⁾				
	d	mm	D	mm	B	mm	r _a	mm	in	Dynamic C ³⁾		Static C ₀		Open and Shielded Grease		Single and Double Sealed Grease	
										N	lbf	N	lbf	RPM	RPM	RPM	
1800S	10	.3937	19	.7480	5	.1969	.30	.012	62	.10	1 820	410	930	209	36 000	43 000	20 000
1801S	12	.4724	21	.8268	5	.1969	.30	.012	68	.11	1 900	427	1 040	234	32 000	38 000	19 000
1802S	15	.5906	24	.9449	5	.1969	.30	.012	80	.12	2 080	468	1 250	281	28 000	34 000	17 000
1803S	17	.6693	26	1.0236	5	.1969	.30	.012	91	.14	2 250	505	1 460	328	24 000	30 000	16 000
1804S	20	.7874	32	1.2598	7	.2756	.30	.012	141	.22	3 510	790	2 240	504	19 000	24 000	13 000
1805S	25	.9843	37	1.4567	7	.2756	.30	.012	184	.28	4 360	980	2 900	652	17 000	20 000	11 000
1806S	30	1.1811	42	1.6535	7	.2756	.30	.012	208	.32	4 490	1 010	3 400	764	15 000	18 000	9 500
1807S	35	1.3780	47	1.8504	7	.2756	.30	.012	233	.36	4 750	1 070	3 800	854	13 000	16 000	8 000
1808S	40	1.5748	52	2.0472	7	.2756	.30	.012	257	.40	4 940	1 110	4 150	933	11 000	14 000	7 500
1809S	45	1.7717	58	2.2835	7	.2756	.30	.012	315	.49	6 050	1 360	5 100	1 150	9 500	12 000	6 700
1810S	50	1.9685	65	2.5591	7	.2756	.30	.012	347	.54	6 240	1 400	5 500	1 240	9 000	11 000	6 000
1811S	55	2.1654	72	2.8346	9	.3543	.30	.012	454	.70	8 320	1 870	7 350	1 650	8 500	10 000	5 180
1812S	60	2.3622	78	3.0709	10	.3937	.30	.012	499	.77	8 710	1 960	8 000	1 800	7 500	9 000	4 800
1813S	65	2.5591	85	3.3465	10	.3937	.60	.025	679	1.05	11 700	2 630	11 000	2 470	7 000	8 500	4 500
1814S	70	2.7559	90	3.5433	10	.3937	.60	.025	741	1.15	12 100	2 720	11 800	2 650	6 700	8 000	4 300
1815S	75	2.9528	95	3.7402	10	.3937	.60	.025	803	1.24	12 500	2 810	12 900	2 900	6 300	7 500	4 000
1816S	80	3.1496	100	3.9370	10	.3937	.60	.025	864	1.32	13 000	2 920	13 700	3 080	6 000	7 000	3 600
1817S	85	3.3465	110	4.3307	13	.5118	1.0	.040	1 230	1.90	19 500	4 380	19 600	4 410	5 300	6 300	3 400
1818S	90	3.5433	115	4.5276	13	.5118	1.0	.040	1 280	1.98	19 500	4 380	20 400	4 590	5 300	6 300	3 200
1819S	95	3.7402	120	4.7244	13	.5118	1.0	.040	1 330	2.06	19 900	4 470	21 200	4 770	5 000	6 000	3 000
1820S	100	3.9370	125	4.9213	13	.5118	1.0	.040	1 380	2.14	20 300	4 560	22 000	4 950	4 800	5 600	3 000
1821S	105	4.1339	130	5.1181	13	.5118	1.0	.040	1 480	2.29	20 800	4 680	23 600	5 310	4 500	5 300	2 800
1822S	110	4.3307	140	5.5118	16	.6299	1.0	.040	1 910	2.95	28 100	6 320	30 500	6 860	4 300	5 000	2 600
1824S	120	4.7244	150	5.9055	16	.6299	1.0	.040	2 060	3.19	29 100	6 540	32 500	7 310	3 800	4 500	2 400
1826S	130	5.1181	165	6.4961	18	.7087	1.0	.040	2 660	4.13	37 700	8 480	43 000	9 670	3 600	4 300	2 200
1828S	140	5.5118	175	6.8898	18	.7087	1.0	.040	2 870	4.46	39 000	8 770	46 500	10 500	3 400	4 000	2 000
1830S	150	5.9055	190	7.4803	20	.7874	1.0	.040	3 540	5.49	48 800	11 000	57 000	12 800	3 000	3 600	
1832S	160	6.2992	200	7.8740	20	.7874	1.0	.040	3 690	5.71	49 400	11 100	60 000	13 500	2 800	3 400	
1834S	170	6.6929	215	8.4646	22	.8661	1.0	.040	4 550	7.06	61 800	13 900	73 500	16 500	2 600	3 200	
1836S	180	7.0866	225	8.8583	22	.8661	1.0	.040	4 730	7.34	62 400	14 000	76 500	17 200	2 400	3 000	
1838S	190	7.4803	240	9.4488	24	.9449	1.5	.060	5 690	8.81	74 100	16 700	91 500	20 600	2 200	2 800	
1840S	200	7.8740	250	9.8425	24	.9449	1.5	.060	5 910	9.17	76 100	17 100	95 000	21 400	2 200	2 800	
1844S	220	8.6614	270	10.6299	24	.9449	1.5	.060	6 370	9.87	78 000	17 500	102 000	22 900	1 900	2 400	
1848S	240	9.4488	300	11.8110	28	1.1024	2.0	.080	8 670	13.4	108 000	24 300	140 000	31 500	1 800	2 200	
1852S	260	10.2362	320	12.5984	28	1.1024	2.0	.080	9 330	14.5	111 000	25 000	150 000	33 700	1 700	2 000	
1856S	280	11.0236	350	13.7795	33	1.2992	2.0	.080	11 500	17.8	138 000	31 000	183 000	41 100	1 600	1 900	
1860S	300	11.8110	380	14.9606	38	1.4961	2.0	.080	14 200	22.0	172 000	38 700	228 000	51 300	1 400	1 700	
1864S	320	12.5984	400	15.7480	38	1.4961	2.0	.080	14 700	22.9	172 000	38 700	236 000	53 100	1 300	1 600	
1868S	340	13.3858	420	16.5354	38	1.4961	2.0	.080	15 900	24.6	178 000	40 000	255 000	57 300	1 200	1 500	
1872S	360	14.1732	440	17.3228	38	1.4961	2.0	.080	16 400	25.5	182 000	40 900	260 000	58 500	1 100	1 400	
1876S	380	14.9606	480	18.8976	46	1.8110	2.0	.080	22 700	35.3	242 000	54 400	365 000	82 100	1 000	1 300	
1880S	400	15.7480	500	19.6850	46	1.8110	2.0	.080	23 700	36.7	247 000	55 500	380 000	85 400	1 000	1 300	
1884S	420	16.5354	520	20.4724	46	1.8110	2.0	.080	24 600	38.1	251 000	56 400	390 000	87 700	950	1 200	
1888S	440	17.3228	540	21.2598	46	1.8110	2.0	.080	25 500	39.5	255 000	57 300	405 000	91 000	900	1 100	
1892S	460	18.1102	580	22.8346	56	2.2047	2.5	.100	33 300	51.7	312 000	70 100	530 000	119 000	900	1 100	
1896S	480	18.8976	600	23.6220	56	2.2047	2.5	.100	34 700	53.7	325 000	73 100	560 000	126 000	850	1 000	

¹⁾ Fillet radius indicates maximum fillet radius on shaft or in housing which bearing corner will clear.
²⁾ Listed values are for pressed steel cage for 1800S through 1828S and 1834S and 1856S. All others for outer land guided machined bronze. The values have been determined through historical application and practice. For a more complete explanation, see page 276.
³⁾ Rating for one million revolutions or 500 hours at 33 1/3 RPM.

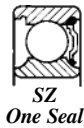
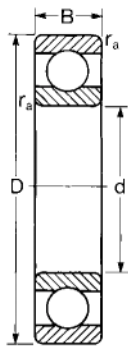

1900-S Series bearings are single-row radial conrad-type bearings that can accommodate light radial loads, two-directional thrust loads, or a combination of both. They are designed for applications where a lack of space or limitations on weight require a bearing with a thinner section than 100-KS Series bearings. Some sizes are available with shields or seals.

MRC Bearing Number	Bore		Outside Diameter		Width		Fillet Radius ¹⁾		Basic Radial Load Rating				Speed Rating ²⁾				
	d	mm	D	mm	B	mm	r _a	mm	ZD ²⁾		Dynamic C ³⁾		Static C ₀		Open and Shielded Grease	Shielded Oil	Single and Double Sealed Grease
									mm	in	N	lbf	N	lbf	RPM	RPM	RPM
1900S	10	.3937	22	.8661	6	.2362	.30	.012	84	.13	2 510	565	1 120	252	34 000	40 000	19 000
1901S	12	.4724	24	.9449	6	.2362	.30	.012	103	.16	2 910	655	1 500	337	30 000	36 000	18 000
1902S	15	.5906	28	1.1024	7	.2756	.30	.012	142	.22	4 030	906	2 040	459	24 000	30 000	16 000
1903S	17	.6693	30	1.1811	7	.2756	.30	.012	155	.24	4 360	980	2 320	522	22 000	28 000	14 000
1904S	20	.7874	37	1.4567	9	.3543	.30	.012	252	.39	6 370	1 430	3 650	821	18 000	22 000	12 000
1905S	25	.9843	42	1.6535	9	.3543	.30	.012	271	.42	6 630	1 490	4 150	933	16 000	19 000	10 000
1906S	30	1.1811	47	1.8504	9	.3543	.30	.012	317	.49	7 280	1 640	5 000	1 120	14 000	17 000	8 500
1907S	35	1.3780	55	2.1654	10	.3937	.64	.025	432	.67	9 560	2 150	6 800	1 530	11 000	14 000	7 500
1908S	40	1.5748	62	2.4409	12	.4724	.64	.025	637	.99	13 800	3 100	10 000	2 250	10 000	13 000	6 700
1909S	45	1.7717	68	2.6772	12	.4724	.64	.025	683	1.06	14 000	3 150	10 800	2 430	9 000	11 000	6 000
1910S	50	1.9685	72	2.8346	12	.4724	.64	.025	728	1.13	14 600	3 280	11 800	2 650	8 500	10 000	5 600
1911S	55	2.1654	80	3.1496	13	.5118	1.0	.040	864	1.34	16 500	3 710	14 000	3 150	8 000	9 500	5 000
1912S	60	2.3622	85	3.3465	13	.5118	1.0	.040	864	1.34	16 500	3 710	14 300	3 210	7 500	9 000	4 500
1913S	65	2.5591	90	3.5433	13	.5118	1.0	.040	968	1.50	17 400	3 910	16 000	3 600	6 700	8 000	4 300
1914S	70	2.7559	100	3.9370	16	.6299	1.0	.040	1 300	2.01	23 800	5 350	21 200	4 770	6 300	7 500	4 000
1915S	75	2.9528	105	4.1339	16	.6299	1.0	.040	1 370	2.13	24 200	5 440	22 400	5 040	6 000	7 000	3 600
1916S	80	3.1496	110	4.3307	16	.6299	1.0	.040	1 450	2.25	25 100	5 640	24 000	5 400	5 600	6 700	3 400
1917S	85	3.3465	120	4.7244	18	.7087	1.0	.040	1 810	2.81	31 900	7 170	30 000	6 740	5 300	6 300	3 200
1918S	90	3.5433	125	4.9213	18	.7087	1.0	.040	1 920	2.97	32 500	7 310	31 500	7 080	5 000	6 000	3 100
1919S	95	3.7402	130	5.1181	18	.7087	1.0	.040	2 025	3.14	33 800	7 600	33 500	7 530	4 800	5 600	2 900
1920S	100	3.9370	140	5.5118	20	.7874	1.0	.040	2 550	3.96	42 300	9 510	41 500	9 330	4 500	5 300	2 700
1921S	105	4.1339	145	5.7087	20	.7874	1.0	.040	2 770	4.18	44 200	9 940	44 000	9 890	4 300	5 000	2 600
1922S	110	4.3307	150	5.9055	20	.7874	1.0	.040	2 770	4.18	43 600	9 800	44 000	9 890	4 000	4 800	2 500
1924S	120	4.7244	165	6.4961	22	.8661	1.0	.040	3 460	5.36	55 300	12 400	57 000	12 800	3 600	4 300	2 300
1926S	130	5.1181	180	7.0866	24	.9449	1.5	.060	4 100	6.35	65 000	14 600	67 000	15 100	3 400	4 000	2 100
1928S	140	5.5118	190	7.4803	24	.9449	1.5	.060	4 320	6.70	66 300	14 900	71 000	16 000	3 200	3 800	2 000
1930S	150	5.9055	210	8.2677	28	1.1024	2.0	.080	5 670	8.78	88 400	19 900	93 000	20 900	2 800	3 400	1 800
1932S	160	6.2992	220	8.6614	28	1.1024	2.0	.080	6 000	9.30	92 300	20 700	98 000	22 000	2 600	3 200	1 700
1934S	170	6.6929	230	9.0551	28	1.1024	2.0	.080	6 330	9.82	93 600	21 000	104 000	23 400	2 400	3 000	1 600
1936S	180	7.0866	250	9.8425	33	1.2992	2.0	.080	8 060	12.5	119 000	26 800	132 000	29 700	2 200	2 800	1 500
1938S	190	7.4803	260	10.2362	33	1.2992	2.0	.080	8 060	12.5	117 000	26 300	134 000	30 100	2 200	2 800	1 400
1940S	200	7.8740	280	11.0236	38	1.4961	2.0	.080	10 200	15.8	148 000	33 300	166 000	37 300	2 000	2 600	1 300
1944S	220	8.6614	300	11.8110	38	1.4961	2.0	.080	10 800	16.7	151 000	33 900	176 000	39 600	1 900	2 400	1 200
1948S	240	9.4488	320	12.5984	38	1.4961	2.0	.080	11 900	18.5	159 000	35 800	196 000	44 100	1 800	2 200	1 100
1952S	260	10.2362	360	14.1732	46	1.8110	2.0	.080	16 400	25.4	212 000	47 700	270 000	60 700	1 600	1 900	1 000
1956S	280	11.0236	380	14.9606	46	1.8110	2.0	.080	17 300	26.8	216 000	48 600	285 000	64 100	1 500	1 800	950
1960S	300	11.8110	420	16.5354	56	2.2047	3.0	.120	22 700	35.1	270 000	60 700	375 000	84 300	1 300	1 600	800
1964S	320	12.5984	440	17.3228	56	2.2047	3.0	.120	24 000	37.2	276 000	62 100	390 000	87 700	1 200	1 500	750
1968S	340	13.3858	460	18.1102	56	2.2047	3.0	.120	25 300	39.3	281 000	63 200	415 000	93 300	1 100	1 400	700
1972S	360	14.1732	480	18.8976	56	2.2047	3.0	.120	26 700	41.3	291 000	65 400	440 000	98 900	1 100	1 400	700
1976S	380	14.9606	520	20.4724	65	2.5591	4.0	.160	32 400	50.2	338 000	76 000	530 000	119 000	1 000	1 300	650
1980S	400	15.7480	540	21.2598	65	2.5591	4.0	.160	34 100	52.8	345 000	77 000	560 000	126 000	950	1 200	600
1984S	420	16.5354	560	22.0472	65	2.5591	4.0	.160	35 800	55.5	351 000	78 900	585 000	132 000	900	1 100	550
1988S	440	17.3228	600	23.6220	74	2.9134	4.0	.160	43 100	66.8	410 000	92 200	710 000	160 000	900	1 100	550
1992S	460	18.1102	620	24.4094	74	2.9134	4.0	.160	45 400	70.3	423 000	95 100	750 000	169 000	850	1 000	550

¹⁾ Fillet radius indicates maximum fillet radius on shaft or in housing which bearing corner will clear.

²⁾ Listed values are for pressed steel or polyamide cage, ABEC-1.

For phenolic composition cage, multiply by 1.66 for grease and 2.00 for oil. For machined bronze cage, multiply by 1.25 for grease and 1.50 for oil. For phenolic composition cage, ABEC-5 or 7, multiply by 2.30 for grease and 2.80 for oil. The speed rating adjustment factors have been determined through historical application and practice. For a more complete explanation, see page 276.

³⁾ Rating for one million revolutions or 500 hours at 33 1/3 RPM.

The 100-S Narrow-type Light Series is made up of single-row radial conrad-type bearings with bores ranging from 10 mm to 95 mm.

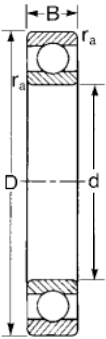

MRC Bearing Number	Bore d		Outside Diameter D		Width B		Fillet Radius ¹⁾ r _a		Basic Radial Load Rating						Speed Rating ²⁾	
									ZD ²⁾		Dynamic C ³⁾		Static C ₀		Open and Shielded	
									mm	in	N	lbf	N	lbf	Grease RPM	Oil RPM
102-S	10	.3937	32	1.2598	9	.3543	.51	.02	181	.28	5 200	1 170	2 450	551	24 000	29 000
103-S	15	.5906	37	1.4567	9	.3543	.51	.02	284	.44	7 800	1 750	3 550	798	21 000	26 000
104-S	20	.7874	42	1.6535	9	.3543	.51	.02	361	.56	9 360	2 100	5 100	1 150	17 000	21 000
105-S	25	.9843	52	2.0472	9	.3543	1.0	.04	458	.71	12 100	2 710	6 700	1 510	14 000	17 000
106-S	30	1.1811	62	2.4409	10	.3937	1.0	.04	632	.98	15 600	3 500	9 300	2 090	11 000	14 000
107-S	35	1.3780	70	2.7559	10	.3937	1.0	.04	755	1.17	16 800	3 780	11 600	2 610	10 000	12 000
108-S	40	1.5748	80	3.1496	11	.4331	1.0	.04	819	1.27	18 200	4 100	12 900	2 900	9 000	11 000
109-S	45	1.7717	85	3.3465	11	.4331	1.0	.04	1 010	1.56	19 800	4 450	16 300	3 670	8 000	9 700
110-S	50	1.9685	90	3.5433	11	.4331	1.0	.04	1 010	1.56	19 900	4 470	16 600	3 730	7 400	9 000
111-S	55	2.1654	100	3.9370	12	.4724	1.0	.04	1 220	1.89	23 400	5 260	20 000	4 500	6 800	8 300
112-S	60	2.3622	105	4.1339	12	.4724	1.0	.04	1 450	2.25	27 000	6 080	23 600	5 300	6 100	7 400
113-S	65	2.5591	115	4.5276	14	.5512	1.0	.04	1 450	2.25	27 000	6 080	23 600	5 300	6 100	7 400
114-S	70	2.7559	120	4.7244	14	.5512	1.0	.04	1 700	2.64	31 200	7 010	28 000	6 300	5 400	6 600
115-S	75	2.9528	130	5.1181	16	.6299	1.5	.06	2 260	3.50	42 300	9 520	36 000	8 090	5 100	6 200
116-S	80	3.1496	135	5.3150	16	.6299	1.5	.06	2 420	3.75	44 200	9 940	39 000	8 770	4 800	5 900
117-S	85	3.3465	145	5.7087	18	.7087	1.5	.06	2 850	4.42	52 700	11 800	45 500	10 200	4 500	5 500
118-S	90	3.5433	150	5.9055	18	.7087	1.5	.06	2 850	4.42	52 700	11 800	46 500	10 500	4 300	5 200
119-S	95	3.7402	160	6.2992	20	.7874	1.5	.06	3 530	5.47	63 700	14 300	57 000	12 800	4 000	4 900

¹⁾ Fillet radius indicates maximum fillet radius on shaft or in housing which bearing corner will clear.

²⁾ Listed values are for pressed steel or polyamide cage, ABEC-1.

For phenolic composition cage, multiply by 1.66 for grease and 2.00 for oil. For machined bronze cage, multiply by 1.25 for grease and 1.50 for oil. For phenolic composition cage, ABEC-5 or 7, multiply by 2.30 for grease and 2.80 for oil. The speed rating adjustment factors have been determined through historical application and practice. For a more complete explanation, see page 276.

³⁾ Rating for one million revolutions or 500 hours at 33 1/3 RPM.

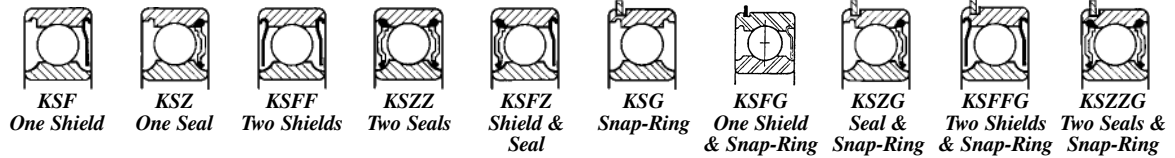
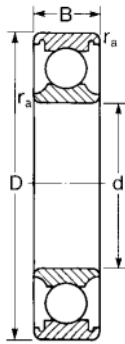

The 100-KS Extra Light Series consists of single-row radial conrad-type bearings made with bores from 10 mm to 320 mm for light to moderate radial loads, two-directional thrust loads, or a combination of both, where space is somewhat limited. This series is available in plain, shielded, or sealed types, as well as with snap-rings.

MRC Bearing Number	Bore d		Outside Diameter D		Width B		Fillet Radius ¹⁾ r _a		Basic Radial Load Rating				Speed Rating ²⁾				
									Dynamic C ³⁾		Static C ₀		Open and Shielded Grease		Single and Double Sealed Grease		
									N	lbf	N	lbf	RPM	RPM	RPM		
100-KS	10	.3937	26	1.0236	8	.3150	.30	.012	181	.28	4 620	1 040	1 960	440	30 000	36 000	19 000
101-KS	12	.4724	28	1.1024	8	.3150	.30	.012	181	.28	5 070	1 140	2 360	530	26 000	32 000	17 000
102-KS	15	.5906	32	1.2598	9	.3543	.30	.012	206	.32	5 590	1 260	2 850	640	22 000	28 000	14 000
103-KS	17	.6693	35	1.3780	10	.3937	.30	.012	226	.35	6 050	1 360	3 250	730	19 000	24 000	13 000
104-KS	20	.7874	42	1.6535	12	.4724	.64	.025	361	.56	9 360	2 100	5 000	1 120	17 000	20 000	11 000
105-KS	25	.9843	47	1.8504	12	.4724	.64	.025	458	.71	11 200	2 520	6 550	1 470	15 000	18 000	9 500
106-KS	30	1.1811	55	2.1654	13	.5118	1.0	.04	561	.87	13 300	2 990	8 300	1 870	12 000	15 000	8 000
107-KS	35	1.3780	62	2.4409	14	.5512	1.0	.04	691	1.07	15 800	3 570	10 200	2 290	10 000	13 000	7 000
108-KS	40	1.5748	68	2.6772	15	.5906	1.0	.04	909	1.41	20 800	4 680	11 600	2 610	9 500	12 000	6 300
109-KS	45	1.7717	75	2.9528	16	.6299	1.0	.04	1 090	1.69	23 400	5 270	16 600	3 730	9 000	11 000	5 600
110-KS	50	1.9685	80	3.1496	16	.6299	1.0	.04	1 180	1.83	24 700	5 560	18 000	4 050	8 500	10 000	5 000
111-KS	55	2.1654	90	3.5433	18	.7087	1.0	.04	1 390	2.16	28 100	6 320	21 600	4 880	7 500	9 000	4 500
112-KS	60	2.3622	95	3.7402	18	.7087	1.0	.04	1 610	2.49	32 500	7 310	25 000	5 620	6 700	8 000	4 300
113-KS	65	2.5591	100	3.9370	18	.7087	1.0	.04	1 730	2.68	33 800	7 600	27 000	6 070	6 300	7 500	4 000
114-KS	70	2.7559	110	4.3307	20	.7874	1.0	.04	2 100	3.25	41 000	9 220	32 500	7 310	6 000	7 000	3 600
115-KS	75	2.9528	115	4.5276	20	.7874	1.0	.04	2 260	3.50	42 300	9 510	35 500	7 970	5 600	6 700	3 400
116-KS	80	3.1496	125	4.9213	22	.8661	1.0	.04	2 650	4.11	50 700	11 400	41 500	9 330	5 300	6 300	3 200
117-KS	85	3.3465	130	5.1181	22	.8661	1.0	.04	2 860	4.43	52 700	11 800	45 000	10 100	5 000	6 000	3 000
118-KS	90	3.5433	140	5.5118	24	.9449	1.5	.06	3 280	5.08	61 800	13 900	51 000	11 500	4 800	5 600	2 800
119-KS	95	3.7402	145	5.7087	24	.9449	1.5	.06	3 530	5.47	63 700	14 300	54 000	12 100	4 500	5 300	2 800
120-KS	100	3.9370	150	5.9055	24	.9449	1.5	.06	3 530	5.47	63 700	14 300	54 000	12 100	4 300	5 000	2 600
121-KS	105	4.1339	160	6.2992	26	1.0236	2.0	.08	4 330	6.72	79 300	17 800	65 500	14 700	4 000	4 800	2 400
122-KS	110	4.3307	170	6.6929	28	1.1024	2.0	.08	4 660	7.23	81 800	18 400	73 500	16 500	3 800	4 500	2 400
124-KS	120	4.7244	180	7.0866	28	1.1024	2.0	.08	5 000	7.75	85 200	19 100	80 000	18 000	3 400	4 000	2 200
126-KS	130	5.1181	200	7.8740	33	1.2992	2.0	.08	5 960	9.24	106 000	23 800	100 000	22 500	3 200	3 800	2 000
128-KS	140	5.5118	210	8.2677	33	1.2992	2.0	.08	6 900	10.7	111 000	25 000	108 000	24 300	3 000	3 600	1 800
130-KS	150	5.9055	225	8.8583	35	1.3780	2.0	.08	8 385	13.0	125 000	28 100	125 000	28 100	2 600	3 200	1 700
132-KS	160	6.2992	240	9.4488	38	1.4961	2.0	.08	9 030	14.0	143 000	32 100	143 000	32 100	2 400	3 000	1 600
134-KS	170	6.6929	260	10.2362	42	1.6535	2.0	.08	11 800	18.3	168 000	37 800	173 000	38 900	2 200	2 800	1 500
136-KS	180	7.0866	280	11.0236	46	1.8110	2.0	.08	11 400	17.7	190 000	42 700	200 000	45 000	2 000	2 600	1 400
138-KS	190	7.4803	290	11.4173	46	1.8110	2.0	.08	13 400	20.8	195 000	43 800	216 000	48 600	2 000	2 600	1 400
140-KS	200	7.8740	310	12.2047	51	2.0079	2.0	.08	15 900	24.6	216 000	48 600	245 000	55 100	1 900	2 400	1 300
144-KS	220	8.6614	340	13.3868	56	2.2047	2.5	.10	18 600	28.9	247 000	55 500	290 000	65 200	1 800	2 200	1 100
148-KS	240	9.4488	360	14.1732	56	2.2047	2.5	.10	19 500	30.2	255 000	57 300	315 000	70 800	1 700	2 000	1 000
152-KS	260	10.2362	400	15.7480	65	2.5591	3.0	.12	23 900	37.0	291 000	65 400	375 000	84 300	1 500	1 800	940
156-KS	280	11.0236	420	16.5354	65	2.5591	3.0	.12	25 700	39.9	302 000	67 900	405 000	91 000	1 400	1 700	890
160-KS	300	11.8110	460	18.1102	74	2.9134	3.0	.12	31 700	49.2	358 000	80 500	500 000	112 000	1 200	1 500	780
164-KS	320	12.5984	480	18.8976	74	2.9134	3.0	.12	34 000	52.7	371 000	83 400	540 000	121 000	1 100	1 400	730

¹⁾ Fillet radius indicates maximum fillet radius on shaft or in housing which bearing corner will clear.

²⁾ Listed values are for pressed steel or polyamide cage, ABEC-1.

For phenolic composition cage, multiply by 1.66 for grease and 2.00 for oil. For machined bronze cage, multiply by 1.25 for grease and 1.50 for oil. For phenolic composition cage, ABEC-5 or 7, multiply by 2.30 for grease and 2.80 for oil. The speed rating adjustment factors have been determined through historical application and practice. For a more complete explanation, see page 276.

³⁾ Rating for one million revolutions or 500 hours at 33 1/3 RPM.

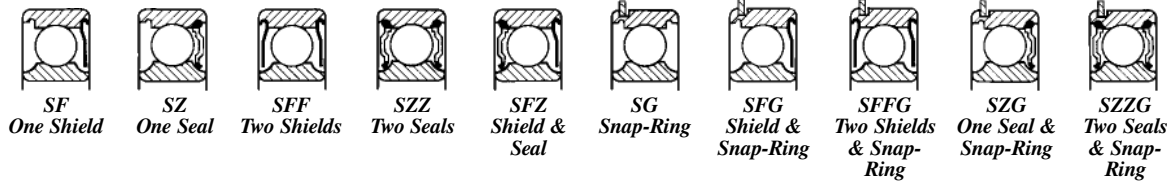
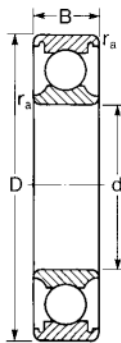

200-S Light Series bearings are single-row radial con-rad-type bearings made with bores from 10 mm to 120 mm. They are used in applications with moderate to heavy radial loads, two-directional thrust loads, or a combination of both.

MRC Bearing Number	Bore d		Outside Diameter D		Width B		Fillet Radius ¹⁾ r _a		Basic Radial Load Rating				Speed Rating ²⁾				
									ZD ²⁾		Dynamic C ³⁾		Static C ₀		Open and Shielded Grease		Single and Double Sealed Grease
									mm	in	N	lbf	N	lbf	RPM	RPM	RPM
200-S	10	.3937	30	1.8111	9	.3543	.64	.025	181	.28	5 070	1 140	2 360	531	24 000	30 000	17 000
201-S	12	.4724	32	1.2598	10	.3937	.64	.025	252	.39	6 890	1 550	3 100	697	22 000	28 000	15 000
202-S	15	.5906	35	1.3780	11	.4331	.64	.025	290	.45	7 800	1 750	3 250	843	19 000	24 000	13 000
203-S	17	.6693	40	1.5748	12	.4724	.64	.025	361	.56	9 560	2 150	4 750	1 070	17 000	20 000	12 000
204-S	20	.7874	47	1.8504	14	.5512	1.0	.04	503	.78	12 700	2 860	6 550	1 470	15 000	18 000	10 000
205-S	25	.9843	52	2.0472	15	.5906	1.0	.04	568	.88	14 000	3 150	7 800	1 750	12 000	15 000	8 500
206-S	30	1.1811	62	2.4409	16	.6299	1.0	.04	819	1.27	19 500	4 380	11 200	2 520	10 000	13 000	7 500
207-S	35	1.3780	72	2.8346	17	.6693	1.0	.04	1 110	1.72	25 500	5 730	15 300	3 440	9 000	11 000	6 300
208-S	40	1.5748	80	3.1496	18	.7087	1.0	.04	1 360	2.11	30 700	6 900	19 000	4 270	8 500	10 000	5 600
209-S	45	1.7717	85	3.3465	19	.7480	1.0	.04	1 510	2.35	33 200	7 460	21 600	4 860	7 500	9 000	5 000
210-S	50	1.9685	90	3.5433	20	.7874	1.0	.04	1 610	2.50	35 100	7 890	23 200	5 220	7 000	8 500	4 800
211-S	55	2.1654	100	3.9370	21	.8268	1.5	.06	2 040	3.16	43 600	9 800	29 000	6 520	6 300	7 500	4 300
212-S	60	2.3622	110	4.3307	22	.8661	1.5	.06	2 280	3.53	47 500	10 700	32 500	7 310	6 000	7 000	4 000
213-S	65	2.5591	120	4.7244	23	.9055	1.5	.06	2 770	4.30	55 900	12 600	40 500	9 110	5 300	6 300	3 600
214-S	70	2.7559	125	4.9213	24	.9449	1.5	.06	3 060	5.18	60 500	13 600	45 000	10 100	5 000	6 000	3 400
215-S	75	2.9528	130	5.1181	25	.9843	1.5	.06	3 350	5.20	66 300	14 900	49 000	11 000	4 800	5 600	3 200
216-S	80	3.1496	140	5.5118	26	1.0236	2.0	.08	3 630	5.63	72 800	16 400	53 000	11 900	4 500	5 300	3 000
217-S	85	3.3465	150	5.9055	28	1.1024	2.0	.08	4 260	6.60	83 200	18 700	64 000	14 400	4 300	5 000	2 800
218-S	90	3.5433	160	6.2992	30	1.1811	2.0	.08	5 050	7.83	95 600	21 500	73 500	16 500	3 800	4 500	2 600
219-S	95	3.7402	170	6.6929	32	1.2598	2.0	.08	5 670	8.79	108 000	24 300	81 500	18 300	3 600	4 300	2 400
220-S	100	3.9370	180	7.0866	34	1.3386	2.0	.08	6 450	10.00	124 000	27 900	93 000	20 900	3 400	4 000	2 400
221-S	105	4.1339	190	7.4803	36	1.4173	2.0	.08	7 280	11.3	133 000	29 900	104 000	23 400	3 200	3 800	2 200
222-S	110	4.3307	200	7.8740	38	1.4961	2.0	.08	8 190	12.7	143 000	32 100	118 000	26 500	3 000	3 600	2 000
224-S	120	4.7244	215	8.4646	40	1.5748	2.0	.08	8 970	13.9	146 000	32 800	118 000	26 500	2 800	3 400	1 900

¹⁾ Fillet radius indicates maximum fillet radius on shaft or in housing which bearing corner will clear.

²⁾ Listed values are for pressed steel or polyamide cage, ABEC-1.

For phenolic composition cage, multiply by 1.66 for grease and 2.00 for oil. For machined bronze cage, multiply by 1.25 for grease and 1.50 for oil. For phenolic composition cage, ABEC-5 or 7, multiply by 2.30 for grease and 2.80 for oil. The speed rating adjustment factors have been determined through historical application and practice. For a more complete explanation, see page 276.

³⁾ Rating for one million revolutions or 500 hours at 33 1/3 RPM.

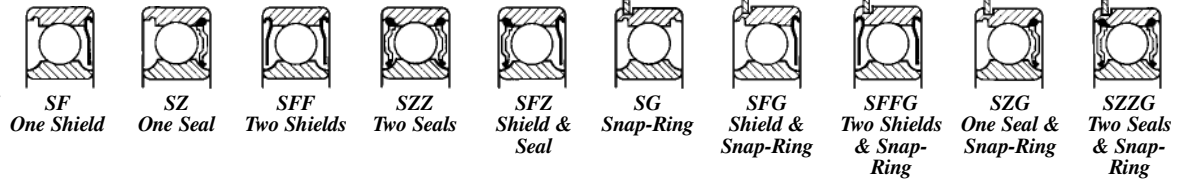
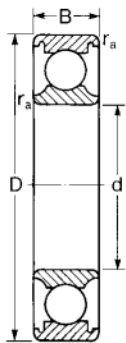

300-S Medium Series bearings are used with heavy radial loads, two-directional thrust loads, or a combination of both.

MRC Bearing Number	Bore d		Outside Diameter D		Width B		Fillet Radius ¹⁾ r _a		Basic Radial Load Rating				Speed Rating ²⁾				
									ZD ²⁾		Dynamic C ³⁾		Static C ₀		Open and Shielded Grease		Single and Double Sealed Grease
									mm	in	N	lbf	N	lbf	RPM	RPM	RPM
300-S	10	.3937	35	1.3780	11	.4331	.64	.025	303	.47	8 060	1 810	3 400	764	20 000	26 000	15 000
301-S	12	.4724	37	1.4567	12	.4724	1.0	.04	381	.59	9 750	2 190	4 150	933	19 000	24 000	14 000
302-S	15	.5906	42	1.6535	13	.5118	1.0	.04	439	.68	11 400	2 560	5 400	1 210	17 000	20 000	12 000
303-S	17	.6693	47	1.8504	14	.5512	1.0	.04	535	.83	13 500	3 030	6 550	1 470	16 000	19 000	11 000
304-S	20	.7874	52	2.0472	15	.5906	1.0	.04	632	.98	15 900	3 570	7 800	1 750	13 000	16 000	9 500
305-S	25	.9843	62	2.4409	17	.6693	1.0	.04	864	1.34	21 200	4 760	10 800	2 430	11 000	14 000	7 500
306-S	30	1.1811	72	2.8346	19	.7480	1.0	.04	1 210	1.88	28 100	6 320	16 000	3 600	9 000	11 000	6 300
307-S	35	1.3780	80	3.1496	21	.8268	1.5	.06	1 460	2.26	33 200	7 460	19 000	4 270	8 500	10 000	6 000
308-S	40	1.5748	90	3.5433	23	.9055	1.5	.06	1 820	2.82	41 000	9 220	24 000	5 400	7 500	9 000	5 000
309-S	45	1.7717	100	3.9370	25	.9843	1.5	.06	2 440	3.62	52 700	11 900	31 500	7 080	6 700	8 000	4 500
310-S	50	1.9685	110	4.3307	27	1.0630	2.0	.08	2 900	4.50	61 800	13 900	38 000	8 540	6 300	7 500	4 300
311-S	55	2.1654	120	4.7244	29	1.1417	2.0	.08	3 410	5.28	71 500	16 100	45 000	10 100	5 600	6 700	3 800
312-S	60	2.3622	130	5.1181	31	1.2205	2.0	.08	3 950	6.13	81 900	18 400	52 000	11 700	5 000	6 000	3 400
313-S	65	2.5591	140	5.5118	33	1.2992	2.0	.08	4 540	7.03	92 300	20 800	60 000	13 500	4 800	5 600	3 200
314-S	70	2.7559	150	5.9055	35	1.3780	2.0	.08	5 160	8.00	104 000	23 400	68 000	15 300	4 500	5 300	3 000
315-S	75	2.9528	160	6.2992	37	1.4567	2.0	.08	5 820	9.03	114 000	25 600	76 500	17 200	4 300	5 000	2 800
316-S	80	3.1496	170	6.6929	39	1.5354	2.0	.08	6 515	10.1	124 000	27 900	86 500	19 400	3 800	4 500	2 600
317-S	85	3.3465	180	7.0866	41	1.6142	2.5	.10	7 290	11.3	133 000	29 900	96 500	21 700	3 600	4 300	2 400
318-S	90	3.5433	190	7.4803	43	1.6929	2.5	.10	8 060	12.5	143 000	32 100	108 000	24 300	3 400	4 000	2 400
319-S	95	3.7402	200	7.8740	45	1.7717	2.5	.10	8 900	13.8	153 000	34 400	118 000	26 500	3 200	3 800	2 200
320-S	100	3.9370	215	8.4646	47	1.8504	2.5	.10	10 600	16.5	174 000	39 100	140 000	31 500	3 000	3 600	2 100
321-S	105	4.1339	225	8.8583	49	1.9291	2.5	.10	11 600	18.0	182 000	40 800	153 000	34 400	2 800	3 400	2 000
322-S	110	4.3307	240	9.4488	50	1.9685	2.5	.10	13 600	21.1	203 000	45 600	180 000	40 500	2 600	3 200	1 800

¹⁾ Fillet radius indicates maximum fillet radius on shaft or in housing which bearing corner will clear.

²⁾ Listed values are for pressed steel or polyamide cage, ABEC-1.

For phenolic composition cage, multiply by 1.66 for grease and 2.00 for oil. For machined bronze cage, multiply by 1.25 for grease and 1.50 for oil. For phenolic composition cage, ABEC-5 or 7, multiply by 2.30 for grease and 2.80 for oil. The speed rating adjustment factors have been determined through historical application and practice. For a more complete explanation, see page 276.

³⁾ Rating for one million revolutions or 500 hours at 33 1/3 RPM.

This series is made up of single-row radial conrad-type bearings made with bores ranging from 17 mm to 110 mm. They are used in applications with very heavy radial loads, two-directional thrust loads, or a combination of both.

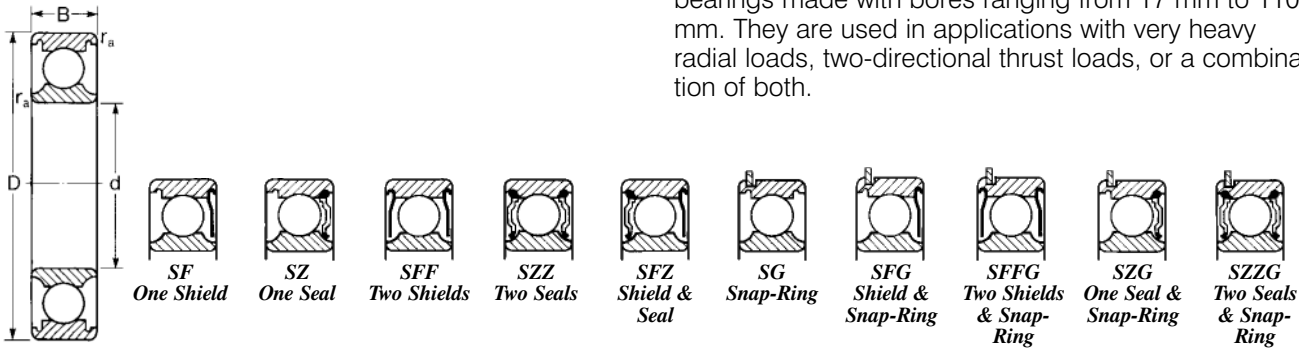

MRC Bearing Number	Bore		Outside Diameter		Width		Fillet Radius ¹⁾		Basic Radial Load Rating				Speed Rating ²⁾				
	d	in	D	in	B	in	r _a	in	ZD ²⁾		Dynamic C ³⁾		Static C ₀		Open and Shielded Grease		Single and Double Sealed Grease
									mm	in	N	lbf	N	lbf	RPM	RPM	RPM
403-S	17	.6693	62	2.4409	17	.6693	1.0	.04	968	1.50	22 900	5 150	10 800	2 430	12 000	15 000	8 500
404-S	20	.7874	72	2.8346	19	.7480	1.0	.04	1 370	2.12	30 700	6 900	15 000	3 370	10 000	13 000	7 300
405-S	25	.9843	80	3.1496	21	.8268	1.5	.06	1 590	2.47	35 800	8 050	19 300	4 340	9 000	11 000	6 400
406-S	30	1.1811	90	3.5433	23	.9055	1.5	.06	1 950	3.02	43 600	9 800	23 600	5 310	8 500	10 000	5 600
407-S	35	1.3780	100	3.9370	25	.9843	1.5	.06	2 540	3.94	55 300	12 400	31 000	6 970	7 000	8 500	4 900
408-S	40	1.5748	110	4.3307	27	1.0630	2.0	.08	2 980	4.62	63 700	14 300	36 500	8 210	6 700	8 000	4 400
409-S	45	1.7717	120	4.7244	29	1.1417	2.0	.08	3 710	5.75	76 100	17 100	45 000	10 100	6 000	7 000	4 000
410-S	50	1.9685	130	5.1181	31	1.2205	2.0	.08	4 520	7.00	87 100	19 600	52 000	11 700	5 200	6 300	3 700
411-S	55	2.1654	140	5.5118	33	1.2992	2.0	.08	5 100	7.90	99 500	22 400	62 000	13 900	5 000	6 000	3 400
412-S	60	2.3622	150	5.9055	35	1.3780	2.0	.08	5 710	8.86	108 000	24 300	69 500	15 600	4 800	5 600	3 100
413-S	65	2.5591	160	6.2992	37	1.4567	2.0	.08	6 370	9.87	119 000	26 800	78 000	17 500	4 500	5 300	2 900
414-S	70	2.7559	180	7.0866	42	1.6535	2.5	.10	8 510	13.2	143 000	32 100	104 000	23 400	3 800	4 500	2 600
415-S	75	2.9528	190	7.4803	45	1.7717	2.5	.10	9 350	14.5	153 000	34 400	114 000	25 600	3 600	4 300	2 500
416-S	80	3.1496	200	7.8740	48	1.8898	2.5	.10	10 200	15.8	163 000	36 600	125 000	28 100	3 400	4 000	2 300
417-S	85	3.3465	210	8.2677	52	2.0472	3.0	.12	11 000	17.1	174 000	39 100	137 000	30 800	3 200	3 800	2 200
418-S	90	3.5433	225	8.8583	54	2.1260	3.0	.12	12 800	19.9	186 000	41 800	150 000	33 700	3 000	3 600	2 100
419-S	95	3.7402	250	9.8425	55	2.1654	3.0	.12	13 800	21.4	203 000	45 600	173 000	38 900	2 700	3 300	1 900
420-S	100	3.9370	265	10.4331	60	2.3622	3.0	.12	15 900	24.6	225 000	50 600	200 000	45 000	2 500	3 100	1 800
421-S	105	4.1339	290	11.4173	65	2.5591	3.0	.12	18 100	28.0	247 000	55 500	228 000	51 300	2 400	2 900	1 600
422-S	110	4.3307	320	12.5984	70	2.7559	3.0	.12	20 300	31.6	270 000	60 700	260 000	58 500	2 100	2 600	1 500

¹⁾ Fillet radius indicates maximum fillet radius on shaft or in housing which bearing corner will clear.
²⁾ Listed values are for pressed steel or polyamide cage, ABEC-1.
 For phenolic composition cage, multiply by 1.66 for grease and 2.00 for oil. For machined bronze cage, multiply by 1.25 for grease and 1.50 for oil. For phenolic composition cage, ABEC-5 or 7, multiply by 2.30 for grease and 2.80 for oil. The speed rating adjustment factors have been determined through historical application and practice. For a more complete explanation, see page 276.
³⁾ Rating for one million revolutions or 500 hours at 33 1/3 RPM.

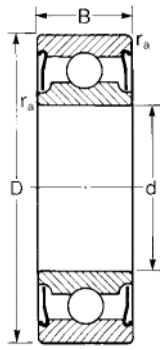

SFFC
Metal Shields

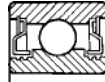

SLLC Removable
Metal Shields

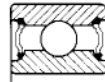

SZZC Synthetic
Rubber Seals

Cartridge-type bearings have an extra large grease chamber packed with high quality lubricant. For applications where space for a lubrication system is limited or conditions demand a larger grease supply inside bearing.

Bearings designated SFFC have non-removable metal shields. Many sizes are available with removable shields (SLLC) or synthetic rubber seals (SZZC).

MRC Bearing Number	Bore d		Outside Diameter D		Width B		Fillet Radius ¹⁾ r _a		Basic Radial Load Rating				Speed Rating ²⁾				
									ZD ²⁾		Dynamic C ³⁾		Static C ₀		Open and Shielded Grease		Single and Double Sealed Grease
									mm	in	N	lbf	N	lbf	RPM	RPM	RPM
38-FFC	8	.3150	22	.8661	11.99	.472	.30	.012	110	.17	3 250	731	1 370	308	36 000	43 000	23 000
220-SFFC	10	.3937	30	1.1811	14.29	5/16	.64	.025	181	.28	5 070	1 140	2 400	540	24 000	30 000	17 000
201-SFFC	12	.4724	32	1.2598	15.88	5/8	.64	.025	252	.39	6 760	1 520	3 000	674	22 000	28 000	15 000
202-SFFC	15	.5906	35	1.3780	15.88	5/8	.64	.025	290	.45	7 610	1 710	3 750	843	19 000	24 000	13 000
203-SFFC	17	.6693	40	1.5748	17.46	11/16	.64	.025	361	.56	9 560	2 150	4 500	1 010	17 000	20 000	12 000
204-SFFC	20	.7874	47	1.8504	20.64	13/16	1.0	.04	503	.78	13 000	2 920	6 700	1 510	15 000	18 000	10 000
205-SFFC	25	.9843	52	2.0472	20.64	13/16	1.0	.04	568	.88	15 100	3 390	8 150	1 830	12 000	15 000	8 500
206-SFFC	30	1.1811	62	2.4409	23.81	15/16	1.0	.04	819	1.27	20 800	4 680	11 400	2 560	10 000	13 000	7 500
207-SFFC	35	1.3780	72	2.8346	26.99	13/16	1.0	.04	1 140	1.76	26 500	5 960	15 300	3 440	9 000	11 000	6 300
208-SFFC	40	1.5748	80	3.1496	30.16	13/16	1.0	.04	1 450	2.25	32 500	7 310	20 000	4 550	8 500	10 000	5 600
209-SFFC	45	1.7717	85	3.3465	30.16	13/16	1.0	.04	1 640	2.54	36 400	8 180	22 800	5 130	7 500	9 000	5 000
210-SFFC	50	1.9685	90	3.5433	30.16	13/16	1.0	.04	1 610	2.50	35 100	7 890	23 200	5 220	7 000	8 500	4 800
211-SFFC	55	2.1654	100	3.9370	33.34	13/16	1.5	.06	2 040	3.16	39 700	8 920	29 000	6 520	6 300	7 500	4 300
213-SFFC	65	2.5591	120	4.7244	38.10	11/2	1.5	.06	3 050	4.73	62 400	14 000	44 000	9 890	5 300	6 300	3 600
214-SFFC	70	2.7559	125	4.9213	39.69	13/16	1.5	.06	3 050	4.73	62 400	14 000	44 000	9 890	5 000	6 000	3 400
216-SFFC	80	3.1496	140	5.5118	44.45	13/4	2.0	.08	3 630	5.63	78 000	17 500	53 000	11 900	4 500	5 300	3 000
304-SFFC	20	.7874	52	2.0472	22.23	7/8	1.0	.04	632	.98	15 900	3 570	7 800	1 750	13 000	16 000	9 500
305-SFFC	25	.9843	62	2.4409	25.40	1	1.0	.04	864	1.34	21 000	4 770	11 000	2 470	11 000	14 000	7 500
306-SFFC	30	1.1811	72	2.8346	30.16	13/16	1.0	.04	1 290	2.00	29 600	6 650	16 600	3 730	9 000	11 000	6 300
307-SFFC	35	1.3780	80	3.1496	34.93	13/16	1.5	.06	1 590	2.47	36 400	8 180	20 000	4 500	8 500	10 000	6 000
308-SFFC	40	1.5748	90	3.5433	36.51	17/16	1.5	.06	2 020	3.13	44 200	9 940	26 000	5 850	7 500	9 000	5 000
309-SFFC	45	1.7717	100	3.9370	39.69	13/16	1.5	.06	2 330	3.62	52 000	11 700	30 000	6 740	6 700	8 000	4 500
310-SFFC	50	1.9685	110	4.3307	44.45	13/4	2.0	.08	2 900	4.50	61 800	13 900	38 000	8 540	6 300	7 500	4 300
311-SFFC	55	2.1654	120	4.7244	49.21	115/16	2.0	.08	3 410	5.28	71 500	16 100	45 000	10 100	5 600	6 700	3 800
312-SFFC	60	2.3622	130	5.1181	53.98	21/8	2.0	.08	3 950	6.13	81 900	18 400	52 000	11 700	5 000	6 000	3 400
313-SFFC	65	2.5591	140	5.5118	58.74	25/16	2.0	.08	4 530	7.03	92 300	20 700	60 000	13 500	4 800	5 600	3 200
314-SFFC	70	2.7559	150	5.9055	63.50	21/2	2.0	.08	5 160	8.00	104 000	23 400	68 000	15 300	4 500	5 300	3 000
315-SFFC	75	2.9528	160	6.2992	68.26	211/16	2.0	.08	6 530	10.1	124 000	27 900	85 000	19 100	4 300	5 000	2 800
316-SFFC	80	3.1496	170	6.6929	68.26	211/16	2.0	.08	7 280	11.3	133 000	29 900	95 000	21 400	3 800	4 500	2 600
317-SFFC	85	3.3465	180	7.0866	73.03	27/8	2.5	.10	7 280	11.3	133 000	29 900	96 500	21 700	3 600	4 300	2 400
318-SFFC	90	3.5433	190	7.4803	73.03	27/8	2.5	.10	8 060	12.5	143 000	32 100	108 000	24 300	3 400	4 000	2 400
320-SFFC	100	3.9370	215	8.4646	82.55	31/4	2.5	.10	11 600	18.0	182 000	40 900	150 000	33 700	3 000	3 600	2 100

¹⁾ Fillet radius indicates maximum fillet radius on shaft or in housing which bearing corner will clear.

²⁾ Listed values are for pressed steel or polyamide cage, ABEC-1.

The values have been determined through historical application and practice. For a more complete explanation, see page 276.

³⁾ Rating for one million revolutions or 500 hours at 33 1/3 RPM.

Dynamic and static equivalent radial load and life rating

Dynamic equivalent radial load

$P = XF_R + YF_A$ P = Dynamic equivalent radial load
 F_R = Radial load
 F_A = Thrust load
 Z = Number of balls
 D = Ball diameter
 X = Radial load factor
 Y = Thrust load factor
 e = Limiting factor for F_A/F_R

Life rating

$L_{10} = \left(\frac{C}{P}\right)^3$ (Millions of revolutions)

or

$L_{10h} = \frac{10^6}{60n} \left(\frac{C}{P}\right)^3$ (Hours)

C = Basic dynamic load rating
 P = Dynamic equivalent radial load
 n = Speed in RPM

Static equivalent radial load

$P_0 = 0.6 F_R + 0.5 F_A$
 P_0 is always $\geq F_R$
 P_0 = Static equivalent radial load
 F_R = Radial load
 F_A = Thrust load

Internal Radial Clearance	F_A / ZD^2		$F_A / F_R > e$		e
	Units N, mm	Units lb, in	X	Y	
Standard (ABMA C0)	0.172	25	0.56	2.30	0.19
	0.345	50		1.99	0.22
	0.689	100		1.71	0.26
	1.03	150		1.56	0.28
	1.38	200		1.45	0.30
	2.07	300		1.31	0.34
	3.45	500		1.15	0.38
	5.17	750		1.04	0.42
6.89	1000	1.00	0.44		
Loose (ABMA C3)	0.172	25	0.44	1.47	0.38
	0.345	50		1.40	0.40
	0.689	100		1.30	0.43
	1.03	150		1.23	0.46
	1.38	200		1.19	0.47
	2.07	300		1.12	0.50
	3.45	500		1.02	0.55
	5.17	750		1.00	0.56
6.89	1000	1.00	0.56		

When $F_A/F_R \leq e$, use $X = 1.0$, $Y = 0$.
 Values of Y and e for loads not shown are obtained from chart to the right.

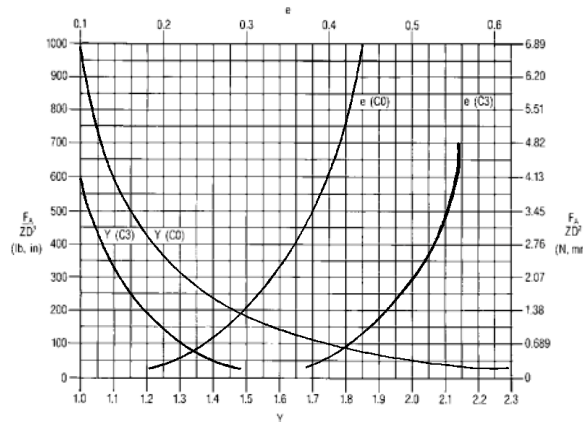

Dynamic equivalent radial load and life calculation examples

Bearing size: 309S
 Speed = 2000 RPM
 Basic dynamic load rating (C) = 11900 lbf
 $ZD^2 = 3.62$

ABMA CO Internal Clearance

Case 1

Radial load (F_R) = 1890
 Equivalent load (P) = $X F_R + Y F_A$
 $P = F_R = 1890$
 Life (L10) = $\left(\frac{C}{P}\right)^3 = \left(\frac{11900}{1890}\right)^3 = 249.6 \times 10^6$ Rev.

or
 Life (L10h) = $\frac{10^6}{60n} \left(\frac{C}{P}\right)^3 = \frac{10^6}{60 \times 2000} \left(\frac{11900}{1890}\right)^3$
 = 2080 Hrs

Case 2

Radial load (F_R) = 1890
 Thrust load (F_A) = 1250
 Equivalent load (P) = $X F_R + Y F_A$
 $F_A/ZD^2 = 1250/3.62 = 345$
 $X = 0.56$
 $Y = 1.27$
 $P = 0.56 \times 1890 + 1.27 \times 1250 = 2646$
 Life (L10) = $\left(\frac{C}{P}\right)^3 = \left(\frac{11900}{2646}\right)^3 = 91.0 \times 10^6$ Rev.

or
 Life (L10h) = $\frac{10^6}{60n} \left(\frac{C}{P}\right)^3 = \frac{10^6}{60 \times 2000} \left(\frac{11900}{2646}\right)^3$
 = 758 Hrs

Case 3

Thrust load (F_A) = 1250
 Equivalent load (P) = $X F_R + Y F_A$
 $F_A/ZD^2 = 1250/3.62 = 345$
 $Y = 1.27$
 $P = 1.27 \times 1250 = 1588$
 Life (L10) = $\left(\frac{C}{P}\right)^3 = \left(\frac{11900}{1588}\right)^3 = 420.8 \times 10^6$ Rev.

or
 Life (L10h) = $\frac{10^6}{60n} \left(\frac{C}{P}\right)^3 = \frac{10^6}{60 \times 2000} \left(\frac{11900}{1588}\right)^3$
 = 3507 Hrs

ABMA C3 Internal Clearance

Case 1

Radial load (F_R) = 1890
 Equivalent load (P) = $X F_R + Y F_A$
 $P = F_R = 1890$
 Life (L10) = $\left(\frac{C}{P}\right)^3 = \left(\frac{11900}{1890}\right)^3 = 249.6 \times 10^6$ Rev.

or
 Life (L10h) = $\frac{10^6}{60n} \left(\frac{C}{P}\right)^3 = \frac{10^6}{60 \times 2000} \left(\frac{11900}{1890}\right)^3$
 = 2080 Hrs

Case 2

Radial load (F_R) = 1890
 Thrust load (F_A) = 1250
 Equivalent load (P) = $X F_R + Y F_A$
 $F_A/ZD^2 = 1250/3.62 = 345$
 $X = 0.44$
 $Y = 1.08$
 $P = 0.44 \times 1890 + 1.08 \times 1250 = 2182$
 Life (L10) = $\left(\frac{C}{P}\right)^3 = \left(\frac{11900}{2182}\right)^3 = 162.2 \times 10^6$ Rev.

or
 Life (L10h) = $\frac{10^6}{60n} \left(\frac{C}{P}\right)^3 = \frac{10^6}{60 \times 2000} \left(\frac{11900}{2182}\right)^3$
 = 1352Hrs

Case 3

Thrust load (F_A) = 1250
 Equivalent load (P) = $X F_R + Y F_A$
 $F_A/ZD^2 = 1250/3.62 = 345$
 $Y = 1.08$
 $P = 1.08 \times 1250 = 1350$
 Life (L10) = $\left(\frac{C}{P}\right)^3 = \left(\frac{11900}{1350}\right)^3 = 684.9 \times 10^6$ Rev.

or
 Life (L10h) = $\frac{10^6}{60n} \left(\frac{C}{P}\right)^3 = \frac{10^6}{60 \times 2000} \left(\frac{11900}{1350}\right)^3$
 = 5708 Hrs

NOTES

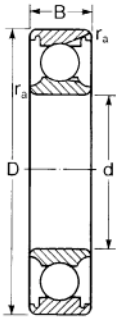

MRC's single-row maximum "M-type" bearings have two characteristics that give the M-type an important advantage over other single-row types when used for heavily loaded positions:

- 1) Maximum radial load-carrying capacity; and
- 2) Ability to carry heavy combined radial and thrust loads.

The M-type bearing is also designated as the "notched" type because it has a filling notch on one side of the inner and outer rings.

Normally furnished with ABMA CO radial clearance.

Cage Types and Materials

Type and material available is a two-piece, pressed steel, ball riding, stayrod cage.

Size	Series	Page
100M	Narrow-Type Light	58
200M	Light	59
300M	Medium	60
400M	Heavy	61
Equivalent Load and Life		62
Life Calculation Examples		63

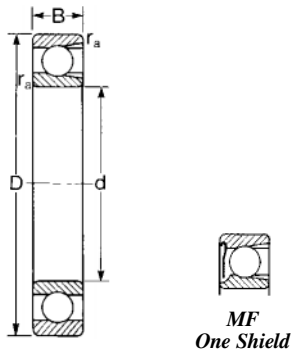

The 100-M Narrow-type Light Series consists of single-row radial filling-notch bearings having bores ranging from 50 mm to 160 mm.

MRC Bearing Number	Bore		Outside Diameter D		Width B		Fillet Radius ¹⁾ r _a	Basic Radial Load Rating				Speed Rating ²⁾		
								Dynamic C ³⁾		Static C ₀		Open and Shielded Grease	Shielded Oil	
	d	in	mm	in	mm	in	mm	in	N	lbf	N	lbf	RPM	RPM
110-M	50	1.9685	90	3.5433	11	.4331	1.0	.04	18 700	4 200	19 600	4 400	5 600	6 800
113-M	65	2.5591	115	4.5276	14	.5512	1.0	.04	31 900	7 170	36 500	8 210	4 400	5 400
117-M	85	3.3465	145	5.7087	18	.7087	1.5	.06	58 300	13 100	68 000	15 300	3 400	4 200
120-M	100	3.9370	160	6.2992	28	1.1024	2.0	.08	96 800	21 800	108 000	24 300	3 000	3 700
120-MF	100	3.9370	160	6.2992	28	1.1024	2.0	.08	96 800	21 800	108 000	24 300	3 000	3 700
124-M	120	4.7244	190	7.4803	32	1.2598	2.0	.08	123 000	27 700	146 000	32 800	2 500	3 100
124-MF	120	4.7244	190	7.4803	32	1.2598	2.0	.08	123 000	27 700	146 000	32 800	2 500	3 100
126-M	130	5.1181	205	8.0709	34	1.3386	2.0	.08	138 000	31 000	166 000	37 300	2 300	2 800
126-MF	130	5.1181	205	8.0709	34	1.3386	2.0	.08	138 000	31 000	166 000	37 300	2 300	2 800
124-M	140	5.5118	220	8.6614	36	1.4173	2.0	.08	157 000	35 300	190 000	42 800	2 100	2 600
128-MF	140	5.5118	220	8.6614	36	1.4173	2.0	.08	157 000	35 300	190 000	42 800	2 100	2 600
132-M	160	6.2992	250	9.8425	40	1.5748	2.0	.08	190 000	42 700	255 000	57 300	1 900	2 300
132-MF	160	6.2992	250	9.8425	40	1.5748	2.0	.08	190 000	42 700	255 000	57 300	1 900	2 300

¹⁾ Fillet radius indicates maximum fillet radius on shaft or in housing which bearing corner will clear.
²⁾ Listed values are for pressed steel or polyamide cage, ABEC-1.
 The values have been determined through historical application and practice. For a more complete explanation, see page 276.
³⁾ Rating for one million revolutions or 500 hours at 33 1/3 RPM.

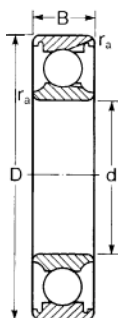

MF
One Shield



MFF
Two Shields



MG
Snap-Ring



MFG
Shield
& Snap-Ring



MFFG
Two Shields
& Snap-Ring

200-M Light Series bearings are single-row maximum capacity filling-notch bearings. They are used in applications with heavy radial loads, or a combination of radial and thrust loads where the radial load is predominant. They are not to be used where only thrust loads are present.

MRC Bearing Number	Bore d		Outside Diameter D		Width B		Fillet Radius ¹⁾ r _a		Basic Radial Load Rating				Speed Rating ²⁾			
									Dynamic C ³⁾		Static C ₀		Open and Shielded Grease		Oil	
									N	lbf	N	lbf	RPM	RPM		
202-M	15	.5906	35	1.3780	11	.4331	.64	.025	8 250	1 850	5 100	1 150	16 000	20 000		
203-M	17	.6693	40	1.5748	12	.4724	.64	.025	8 970	2 020	6 000	1 350	14 000	17 000		
204-M	20	.7874	47	1.8504	14	.5512	1.0	.04	12 500	2 810	8 300	1 870	12 000	15 000		
205-M	25	.9843	52	2.0472	15	.5906	1.0	.04	16 100	3 620	11 200	2 510	11 000	13 000		
206-M	30	1.1811	62	2.4409	16	.6299	1.0	.04	22 900	5 150	17 000	3 820	9 000	11 000		
207-M	35	1.3780	72	2.8346	17	.6693	1.0	.04	29 700	6 680	22 800	5 130	7 800	9 500		
208-M	40	1.5748	80	3.1496	18	.7087	1.0	.04	33 600	7 550	26 500	5 960	7 000	8 500		
209-M	45	1.7717	85	3.3465	19	.7480	1.0	.04	39 300	8 840	32 500	7 310	6 200	7 500		
210-M	50	1.9685	90	3.5433	20	.7874	1.0	.04	39 100	8 790	34 500	7 760	5 700	7 000		
211-M	55	2.1654	100	3.9370	21	.8268	1.5	.06	48 400	10 900	44 000	9 890	5 200	6 300		
212-M	60	2.3622	110	4.3307	22	.8661	1.5	.06	56 100	12 600	51 000	11 500	4 900	6 000		
213-M	65	2.5591	120	4.7244	23	.9055	1.5	.06	69 300	15 600	65 500	14 700	4 300	5 300		
214-M	70	2.7559	125	4.9213	24	.9449	1.5	.06	69 300	15 600	65 500	14 700	4 100	5 000		
215-M	75	2.9528	130	5.1181	25	.9843	1.5	.06	74 800	16 800	72 000	16 200	3 900	4 800		
216-M	80	3.1496	140	5.5118	26	1.0236	2.0	.08	85 800	19 300	86 500	19 400	3 700	4 500		
217-M	85	3.3465	150	5.9055	28	1.1024	2.0	.08	88 000	19 800	93 000	20 900	3 500	4 300		
218-M	90	3.5433	160	6.2992	30	1.1811	2.0	.08	101 000	22 700	108 000	24 300	3 300	4 000		
219-M	95	3.7482	170	6.6929	32	1.2598	2.0	.08	111 000	25 000	118 000	26 500	3 100	3 800		
220-M	100	3.9370	180	7.0866	34	1.3386	2.0	.08	127 000	28 600	134 000	30 100	2 800	3 400		
221-M	105	4.1339	190	7.4803	36	1.4173	2.0	.08	142 000	31 900	153 000	34 400	2 600	3 200		
222-M	110	4.3307	200	7.8740	38	1.4961	2.0	.08	154 000	34 600	170 000	38 200	2 500	3 100		
224-M	120	4.7244	215	8.4646	40	1.5748	2.0	.08	172 000	38 700	200 000	45 000	2 300	2 800		
226-M	130	5.1181	230	9.0551	40	1.5748	2.5	.10	179 000	40 300	216 000	48 500	2 100	2 600		

¹⁾ Fillet radius indicates maximum fillet radius on shaft or in housing which bearing corner will clear.

²⁾ Listed values are for pressed steel or polyamide cage, ABEC-1.

The values have been determined through historical application and practice. For a more complete explanation, see page 276.

³⁾ Rating for one million revolutions or 500 hours at 33 1/3 RPM.

The 300-M Medium Series consists of single-row maximum capacity filling-notch bearings with bores ranging from 17 mm to 110 mm. They are used with very heavy radial loads, or a combination of radial and thrust loads where the radial load is predominant. They are not to be used where only a thrust load is present.

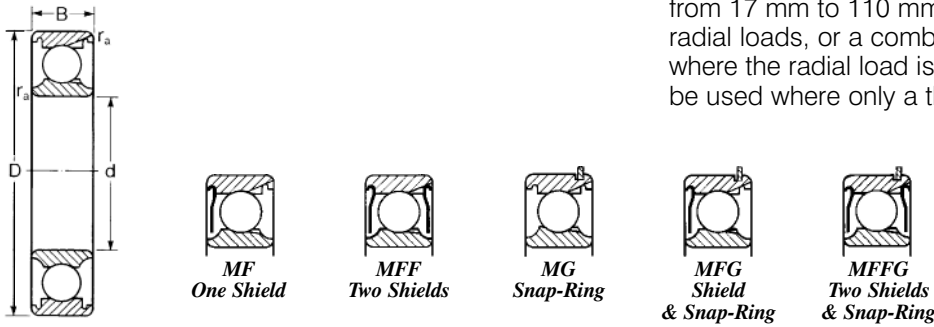

MRC Bearing Number	Bore		Outside Diameter D		Width B		Fillet Radius ¹⁾ r _a		Basic Radial Load Rating				Speed Rating ²⁾	
	d mm	in	mm	in	mm	in	mm	in	Dynamic C ³⁾		Static C ₀		Open and Shielded Oil	
									N	lbf	N	lbf	RPM	RPM
303-M	17	.6693	47	1.8504	14	.5512	1.0	.04	14 200	3 200	8 500	1 910	12 000	15 000
304-M	20	.7874	52	2.0472	15	.5906	1.0	.04	15 900	3 570	10 200	2 280	11 000	14 000
305-M	25	.9843	62	2.4409	17	.6693	1.0	.04	22 900	5 150	15 600	3 510	9 800	12 000
306-M	30	1.1811	72	2.8346	19	.7480	1.0	.04	29 200	6 560	20 800	4 680	7 800	9 500
307-M	35	1.3780	80	3.1496	21	.8268	1.5	.06	39 300	8 830	28 500	6 410	7 000	8 500
308-M	40	1.5748	90	3.5433	23	.9055	1.5	.06	46 800	10 500	36 000	8 090	6 200	7 500
309-M	45	1.7717	100	3.9370	25	.9843	1.5	.06	59 400	13 400	46 500	10 500	5 700	7 000
310-M	50	1.9685	110	4.3307	27	1.0630	2.0	.08	64 400	14 500	52 000	11 700	5 200	6 300
311-M	55	2.1654	120	4.7244	29	1.1417	2.0	.08	79 200	17 800	65 500	14 700	4 600	5 600
312-M	60	2.3622	130	5.1181	31	1.2205	2.0	.08	91 300	20 500	78 000	17 500	4 300	5 300
313-M	65	2.5591	140	5.5118	33	1.2992	2.0	.08	102 000	22 900	90 000	20 200	3 900	4 800
314-M	70	2.7559	150	5.9055	35	1.3780	2.0	.08	114 000	25 600	102 000	22 900	3 700	4 500
315-M	75	2.9528	160	6.2992	37	1.4567	2.0	.08	125 000	28 000	116 000	26 000	3 500	4 300
316-M	80	3.1496	170	6.6929	39	1.5354	2.0	.08	138 000	31 000	129 000	29 000	3 300	4 000
317-M	85	3.3465	180	7.0866	41	1.6142	2.5	.10	147 000	33 000	146 000	32 800	3 100	3 800
318-M	90	3.5433	190	7.4803	43	1.6929	2.5	.10	157 000	35 300	160 000	36 000	2 800	3 400
319-M	95	3.7402	200	7.8740	45	1.7717	2.5	.10	168 000	37 800	180 000	40 500	2 600	3 200
320-M	100	3.9370	215	8.4646	47	1.8504	2.5	.10	194 000	43 600	212 000	47 700	2 500	3 000
321-M	105	4.1339	225	8.8583	49	1.9291	2.5	.10	205 000	46 100	232 000	52 200	2 400	2 900
322-M	110	4.3307	240	9.4488	50	1.9685	2.5	.10	216 000	48 600	250 000	56 200	2 200	2 700

¹⁾ Fillet radius indicates maximum fillet radius on shaft or in housing which bearing corner will clear.

²⁾ Listed values are for pressed steel or polyamide cage, ABEC-1.

The values have been determined through historical application and practice. For a more complete explanation, see page 276.

³⁾ Rating for one million revolutions or 500 hours at 33 1/3 RPM.

400-M Heavy Series bearings are single-row maximum capacity filling-notch bearings with bores ranging from 17 mm to 100 mm. They are used with extremely heavy radial loads, or a combination of radial and thrust loads where the radial load is predominant. They are not used where only thrust loads are present.

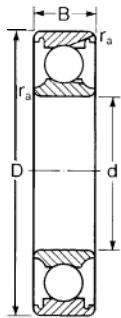

MRC Bearing Number	Bore		Outside Diameter D		Width B		Fillet Radius ¹⁾ r _a		Basic Radial Load Rating				Speed Rating ²⁾	
	d mm	in	mm	in	mm	in	mm	in	Dynamic C ³⁾		Static C ₀		Open and Shielded Grease Oil	
									N	lbf	N	lbf	RPM	RPM
403-M	17	.6693	62	2.4409	17	.6693	1.0	.04	23 300	5 240	14 600	3 280	11 000	13 000
404-M	20	.7874	72	2.8346	19	.7480	1.0	.04	29 200	6 560	18 600	4 210	9 000	11 000
405-M	25	.9843	80	3.1496	21	.8268	1.5	.06	35 800	8 050	23 600	5 270	7 700	9 400
406-M	30	1.1811	90	3.5433	23	.9055	1.5	.06	45 700	10 300	32 500	7 310	6 200	7 500
407-M	35	1.3780	100	3.9370	25	.9843	1.5	.06	53 900	12 100	39 000	8 770	5 600	6 800
408-M	40	1.5748	110	4.3307	27	1.0630	2.0	.08	68 200	15 300	52 000	11 700	5 300	6 500
409-M	45	1.7717	120	4.7244	29	1.1417	2.0	.08	78 100	17 600	61 000	13 700	4 800	5 900
410-M	50	1.9685	130	5.1181	31	1.2205	2.0	.08	88 000	19 800	71 000	16 000	4 400	5 400
411-M	55	2.1654	140	5.5118	33	1.2992	2.0	.08	108 000	24 200	90 000	20 200	4 100	5 000
412-M	60	2.3622	150	5.9055	35	1.3780	2.0	.08	117 000	26 200	102 000	22 900	3 800	4 600
413-M	65	2.5591	160	6.2992	37	1.4567	2.0	.08	128 000	28 800	112 000	25 200	3 400	4 100
414-M	70	2.7559	180	7.0866	42	1.6535	2.5	.10	147 000	33 100	140 000	31 500	3 200	3 900
415-M	75	2.9528	190	7.4803	45	1.7717	2.5	.10	157 000	55 300	153 000	34 400	3 000	3 600
416-M	80	3.1496	200	7.8740	48	1.8898	2.5	.10	176 000	89 600	176 000	39 600	2 800	3 400
417-M	85	3.3465	210	8.2677	52	2.0472	3.0	.12	190 000	42 700	200 000	45 000	2 600	3 200
418-M	90	3.5433	225	8.8583	54	2.1260	3.0	.12	198 000	44 500	212 000	47 700	2 500	3 000
419-M	95	3.7402	250	9.8425	55	2.1654	3.0	.12	229 000	51 500	260 000	58 500	2 300	2 800
420-M	100	3.9370	265	10.4331	60	2.3622	3.0	.12	251 000	56 500	300 000	67 400	2 100	2 600

¹⁾ Fillet radius indicates maximum fillet radius on shaft or in housing which bearing corner will clear.

²⁾ Listed values are for pressed steel or polyamide cage, ABEC-1.

The values have been determined through historical application and practice. For a more complete explanation, see page 276.

³⁾ Rating for one million revolutions or 500 hours at 33⅓ RPM.

Dynamic and static equivalent radial load and life rating

Dynamic equivalent radial load

$$P = F_R + F_A \quad \begin{array}{l} P = \text{Dynamic equivalent radial} \\ \text{load} \\ F_R = \text{Radial load} \\ F_A = \text{Thrust load} \end{array}$$

when $F_A/F_R > 0.6$ or $P > 0.5 C_0$, a non-filling notch bearing is suggested.

C_0 = Basic static radial load rating

Life rating

$$L_{10} = \left(\frac{C}{P}\right)^3 \quad (\text{millions of revolutions})$$

or

$$L_{10h} = \frac{10^6}{60n} \left(\frac{C}{P}\right)^3 \quad (\text{Hours})$$

C = Basic dynamic radial load rating

P = Dynamic equivalent radial load

n = Speed in rpm

Static equivalent radial load

$$P_0 = F_R + 0.5 F_A$$

Provided $F_A/F_R \leq 0.6$

P_0 = Static equivalent radial load

F_R = Radial load

F_A = Thrust load

**Dynamic equivalent radial load
and life calculation examples**

Bearing size: 309M

Speed = 2000 RPM

Basic dynamic load rating (C) = 13400 lbf

ABMA CO Internal Clearance

Case 1Radial load (F_R) = 1890Equivalent load (P) = $F_R + F_A$ P = $F_R = 1890$

$$\text{Life (L}_{10}\text{)} = \left(\frac{C}{P}\right)^3 = \left(\frac{13400}{1890}\right)^3 = 356 \times 10^6 \text{ Rev.}$$

or

$$\begin{aligned}\text{Life (L}_{10\text{h}}\text{)} &= \frac{10^6}{60n} \left(\frac{C}{P}\right)^3 = \frac{10^6}{60 \times 2000} \left(\frac{13400}{1890}\right)^3 \\ &= 2967 \text{ Hrs}\end{aligned}$$

Case 2Radial load (F_R) = 1890Thrust load (F_A) = 950

$$F_A/F_R = 950/1890 = 0.50$$

Since $F_A/F_R < 0.60$ P = $F_R + F_A = 1890 + 950 = 2840$

$$\text{Life (L}_{10}\text{)} = \left(\frac{C}{P}\right)^3 = \left(\frac{13400}{2840}\right)^3 = 105 \times 10^6 \text{ Rev.}$$

or

$$\begin{aligned}\text{Life (L}_{10\text{h}}\text{)} &= \frac{10^6}{60n} \left(\frac{13400}{2840}\right)^3 = \frac{10^6}{60 \times 2000} \left(\frac{13400}{2840}\right)^3 \\ &= 875 \text{ Hrs}\end{aligned}$$

Case 3Radial load (F_R) = 1890Thrust load (F_A) = 1250

$$F_A/F_R = 1250/1890 = 0.66$$

Since $F_A/F_R > 0.60$, use a non-filling notch bearing

NOTES

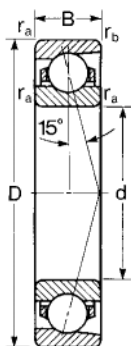

MRC R-type bearings are single-row 15 degree angular contact bearings with one heavy race shoulder and one counterbored race shoulder on the outer ring. Because of this construction, it is possible to incorporate a greater number of balls than in the deep-groove nonfilling notch bearing. R-type bearings have ample radial and thrust capacity for the majority of applications involving heavy radial loads; heavy thrust loads; or combinations of these.

Normally furnished with ABMA C3 radial clearance.

Cage Types and Materials

Cage types and materials available are: two piece pressed steel, ball-riding, bent prong cages; one-piece machined bronze inner ring-riding cages; and one-piece phenolic inner ring-riding cages.

Size	Series	Page
1900R	Extremely Light—Single Bearing	66
1900RD	Extremely Light—Duplex Set	67
100R/RD	Extra Large—Single and Duplex Set	68
100KR	Extra Light—Single Bearing	69
100KRD	Extra Light—Duplex Set	70
200R	Light—Single Bearing	71
200RD	Light—Duplex Set	72
300R	Medium—Single Bearing	73
300RD	Medium—Duplex Set	74
400R/RD	Heavy—Single Bearing and Duplex Set	75
XLS	Inch-Size	76
R	Equivalent Load and Life	78
R	Life Calculation Examples	79
RD	Equivalent Load and Life	80
RD	Life Calculation Examples	81

1900-R Extremely Light Series (Single Bearings)

MRC Bearing Services

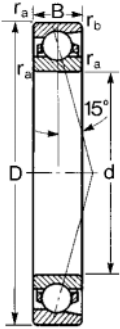

1900-R Extremely Light Series bearings are made with bores ranging from 10 mm to 200 mm. The extremely light section on the 1900-R bearing permits the use of these bearings in applications where there are space and weight limitations. These bearings can accommodate light radial loads and one directional thrust loads, or a combination of both. Use duplex bearings for two-directional thrust loads. 1900-R bearings can be furnished duplex ground for installation in pairs.

MRC Bearing Number	Bore d mm in		Outside Diameter D mm in		Width B mm in		Fillet Radius ¹⁾ r _a r _b ZD ²⁾ mm in mm in mm in					Basic Radial Load Rating				Speed Rating ²⁾		
												Dynamic C ₃₎		Static C ₀		Grease RPM	Oil RPM	
												N	lbf	N	lbf			
1900-R	10	.3937	22	.8661	6	.2362	.30	.012	.10	.004	110	.17	3 120	701	1 560	351	33 000	40 000
1901-R	12	.4724	24	.9449	6	.2362	.30	.012	.10	.004	123	.19	3 250	731	1 800	405	30 000	36 000
1902-R	15	.5906	28	1.1024	7	.2756	.30	.012	.10	.004	187	.29	4 800	1 100	2 700	607	24 000	30 000
1903-R	17	.6693	30	1.1811	7	.2756	.30	.012	.10	.004	206	.32	5 400	1 210	3 000	674	22 000	28 000
1904-R	20	.7874	37	1.4567	9	.3543	.30	.012	.15	.006	400	.62	9 360	2 100	5 850	1 320	18 000	22 000
1905-R	25	.9843	42	1.6535	9	.3543	.30	.012	.15	.006	342	.53	7 610	1 710	5 300	1 190	16 000	19 000
1906-R	30	1.1811	47	1.8504	9	.3543	.30	.012	.15	.006	452	.70	9 750	2 190	7 100	1 600	14 000	17 000
1907-R	35	1.3780	55	2.1654	10	.3937	.64	.025	.15	.006	555	.86	11 200	2 520	9 000	2 020	11 000	14 000
1908-R	40	1.5748	62	2.4409	12	.4724	.64	.025	.15	.006	722	1.12	14 300	3 210	11 600	2 600	10 000	15 000
1909-R	45	1.7717	68	2.6772	12	.4724	.64	.025	.15	.006	806	1.25	15 100	3 400	13 400	3 010	9 000	11 000
1910-R	50	1.9685	72	2.8346	12	.4724	.64	.025	.15	.006	1 070	1.66	19 500	4 380	17 300	3 900	8 500	10 000
1911-R	55	2.1654	80	3.1496	13	.5118	1.0	.04	.30	.012	1 260	1.95	22 900	5 150	20 400	4 590	8 000	9 500
1912-R	60	2.3622	85	3.3465	13	.5118	1.0	.04	.30	.012	1 380	2.15	24 200	5 440	22 800	5 730	7 500	9 000
1913-R	65	2.5591	90	3.5433	13	.5118	1.0	.04	.30	.012	1 450	2.25	24 700	5 550	24 000	5 400	6 700	8 000
1914-R	70	2.7559	100	3.9370	16	.6299	1.0	.04	.30	.012	1 990	3.09	33 200	7 460	32 500	7 300	6 300	7 500
1915-R	75	2.9528	105	4.1339	16	.6299	1.0	.04	.30	.012	2 080	3.23	34 500	7 760	34 500	7 760	6 000	7 000
1916-R	80	3.1496	110	4.3307	16	.6299	1.0	.04	.30	.012	2 180	3.38	34 500	7 760	36 000	8 100	5 600	6 700
1917-R	85	3.3465	120	4.7244	18	.7087	1.0	.04	.60	.024	2 840	4.40	44 900	10 100	46 500	10 500	5 300	6 300
1918-R	90	3.5433	125	4.9213	18	.7087	1.0	.04	.60	.024	3 400	5.27	52 700	11 800	56 000	12 600	5 000	6 000
1919-R	95	3.7402	130	5.1181	18	.7087	1.0	.04	.60	.024	3 090	4.79	47 500	10 700	52 000	11 700	4 800	5 600
1920-R	100	3.9370	140	5.5118	20	.7874	1.0	.04	.60	.024	3 870	6.00	58 500	13 200	64 000	14 400	4 500	5 300
1921-R	105	4.1339	145	5.7087	20	.7874	1.0	.04	.60	.024	4 030	6.25	60 500	13 600	67 000	15 100	4 300	5 000
1922-R	110	4.3307	150	5.9055	20	.7874	1.0	.04	.60	.024	3 820	5.93	55 300	12 400	64 000	14 400	4 000	4 800
1924-R	120	4.7244	165	6.4961	22	.8661	1.0	.04	.60	.024	5 100	7.91	74 100	16 700	85 000	19 100	3 600	4 300
1926-R	130	5.1181	180	7.0866	24	.9449	1.5	.06	.60	.024	6 300	9.77	90 400	20 500	106 000	23 800	3 400	4 000
1928-R	140	5.5118	190	7.4803	24	.9449	1.5	.06	.60	.024	6 580	10.2	95 600	21 400	110 000	24 700	3 200	3 800
1930-R	150	5.9055	210	8.2677	28	1.1024	2.0	.08	1.0	.04	9 090	14.1	125 000	28 200	150 000	33 700	2 800	3 400
1932-R	160	6.2992	220	8.6614	28	1.1024	2.0	.08	1.0	.04	9 420	14.6	127 000	28 600	156 000	35 100	2 600	3 200
1934-R	170	6.6929	230	9.0551	28	1.1024	2.0	.08	1.0	.04	10 200	15.8	133 000	29 800	170 000	38 300	2 400	3 000
1936-R	180	7.0866	250	9.8425	33	1.2992	2.0	.08	1.0	.04	12 800	19.9	168 000	36 000	212 000	47 800	2 200	2 800
1938-R	190	7.4803	260	10.2362	33	1.2992	2.0	.08	1.0	.04	13 400	20.7	174 000	39 100	224 000	50 400	2 200	2 800
1940-R	200	7.8740	280	11.0236	38	1.4961	2.0	.08	1.0	.04	16 800	26.0	216 100	48 600	275 000	61 800	2 000	2 600

¹⁾ Fillet radius indicates maximum fillet radius on shaft or in housing which bearing corner will clear.

²⁾ Listed values are for pressed steel or polyamide cage, ABEC-1.

For phenolic composition cage, multiply by 1.66 for grease and 2.00 for oil. For machined bronze cage, multiply by 1.25 for grease and 1.50 for oil. For phenolic composition cage, ABEC-5 or 7, multiply by 2.30 for grease and 2.80 for oil. The speed rating adjustment factors have been determined through historical application and practice. For a more complete explanation, see page 276.

³⁾ Rating for one million revolutions or 500 hours at 33 1/3 RPM.

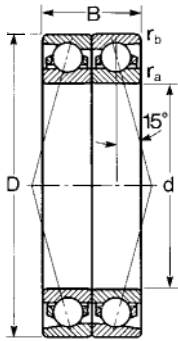

Note: ABEC 1 & 3 are stocked as half-pairs where available.

"D" indicates a duplex ground half pair matched with an identical half pair and is followed by an additional suffix letter to describe the type of duplex. See pages 236 and 237 for suffix description.

Use these values for back-to-back (DB) or face-to-face (DF) mounting arrangements.

MRC Bearing Number	Bore d mm in		Outside Diameter D mm in		Width B mm in		Fillet Radius ¹⁾ r _a r _b mm in mm in					Basic Radial Load Rating				Speed Rating ²⁾		
												Dynamic C ₃ ³⁾		Static C ₀		Grease RPM	Oil RPM	
												N	lbf	N	lbf			
1900-RD	10	.3737	22	.8661	12	.4724	.30	.012	.10	.004	110	.17	5 070	1 140	3 100	697	26 000	32 000
1901-RD	12	.4724	24	.9449	12	.4724	.30	.012	.10	.004	123	.19	5 270	1 180	3 550	798	24 000	29 000
1902-RD	15	.5906	28	1.1024	14	.5512	.30	.012	.10	.004	187	.29	7 930	1 780	5 400	1 210	19 000	24 000
1903-RD	17	.6693	30	1.1811	14	.5512	.30	.012	.10	.004	206	.32	8 710	1 960	6 100	1 370	18 000	22 000
1904-RD	20	.7874	37	1.4567	18	.7087	.30	.012	.15	.006	400	.62	15 300	3 440	11 600	2 600	14 000	18 000
1905-RD	25	.9843	42	1.6535	18	.7087	.30	.012	.15	.006	342	.53	12 400	2 790	10 800	2 430	13 000	15 000
1906-RD	30	1.1811	47	1.8504	18	.7087	.30	.012	.15	.006	452	.70	15 900	3 580	14 300	3 210	11 000	14 000
1907-RD	35	1.3780	55	2.1654	20	.7874	.64	.025	.15	.006	555	.86	18 200	4 090	18 000	4 050	8 800	11 000
1908-RD	40	1.5748	62	2.4409	24	.9449	.64	.025	.15	.006	722	1.12	22 900	5 150	23 200	5 220	8 000	10 000
1909-RD	45	1.7717	68	2.6772	24	.9449	.64	.025	.15	.006	806	1.25	24 700	5 550	26 500	5 960	7 200	8 800
1910-RD	50	1.9685	72	2.8346	24	.9449	.64	.025	.15	.006	1 070	1.66	31 900	7 170	34 500	7 760	6 800	8 000
1911-RD	55	2.1654	80	3.1496	26	1.0236	1.0	.04	.30	.012	1 260	1.95	37 100	8 340	40 500	9 100	6 400	7 600
1912-RD	60	2.3622	85	3.3465	26	1.0236	1.0	.04	.30	.012	1 380	2.15	39 000	8 770	45 500	10 200	6 000	7 200
1913-RD	65	2.5591	90	3.5433	26	1.0236	1.0	.04	.30	.012	1 450	2.25	39 700	8 920	48 000	10 800	5 400	6 400
1914-RD	70	2.7559	100	3.9370	32	1.2598	1.0	.04	.30	.012	1 990	3.09	54 000	12 100	65 500	14 700	5 000	6 000
1915-RD	75	2.9528	105	4.1339	32	1.2598	1.0	.04	.30	.012	2 080	3.23	55 900	12 600	68 000	15 300	4 800	5 600
1916-RD	80	3.1496	110	4.3307	32	1.2598	1.0	.04	.30	.012	2 180	3.38	57 200	12 900	72 000	16 200	4 500	5 400
1917-RD	85	3.3465	120	4.7244	36	1.4173	1.0	.04	.60	.024	2 840	4.40	74 100	16 700	93 000	20 900	4 200	5 000
1918-RD	90	3.5433	125	4.9213	36	1.4173	1.0	.04	.60	.024	3 400	5.27	85 200	19 200	112 000	25 200	4 000	4 800
1919-RD	95	3.7402	130	5.1181	36	1.4173	1.0	.04	.60	.024	3 090	4.77	76 100	17 100	104 000	23 400	3 800	4 500
1920-RD	100	3.9370	140	5.5118	40	1.5748	1.0	.04	.60	.024	3 870	6.00	95 600	21 500	127 000	28 600	3 600	4 200
1921-RD	105	4.1339	145	5.7087	40	1.5748	1.0	.04	.60	.024	4 030	6.25	97 500	21 900	134 000	30 100	3 400	4 000
1922-RD	110	4.3307	150	5.9055	40	1.5748	1.0	.04	.60	.024	3 820	5.93	90 400	20 300	129 000	29 000	3 200	3 800
1924-RD	120	4.7244	165	6.4961	44	1.7323	1.0	.04	.60	.024	5 100	7.91	121 000	27 200	170 000	38 200	2 900	3 400
1926-RD	130	5.1181	180	7.0866	48	1.8898	1.5	.06	.60	.024	6 300	9.77	146 000	32 800	208 000	46 800	2 700	3 200
1928-RD	140	5.5118	190	7.4803	48	1.8898	1.5	.06	.60	.024	6 580	10.2	156 000	35 100	220 000	49 500	2 600	3 000
1930-RD	150	5.9055	210	8.2677	56	2.2047	2.0	.08	1.0	.04	9 090	14.1	203 000	45 600	300 000	67 400	2 200	2 700
1932-RD	160	6.2992	220	8.6614	56	2.2047	2.0	.08	1.0	.04	9 420	14.6	208 000	46 800	315 000	70 800	2 100	2 600
1934-RD	170	6.6929	230	9.0551	56	2.2047	2.0	.08	1.0	.04	10 200	15.8	216 000	48 600	340 000	76 400	1 900	2 400
1936-RD	180	7.0866	250	9.8425	66	2.5984	2.0	.08	1.0	.04	12 800	19.9	276 000	62 000	425 000	95 600	1 800	2 200
1938-RD	190	7.4803	260	10.2362	66	2.5984	2.0	.08	1.0	.04	13 400	20.7	281 000	63 200	440 000	98 900	1 800	2 200
1940-RD	200	7.8740	280	11.0236	76	2.9921	2.0	.08	1.0	.04	16 800	26.0	351 000	78 900	550 000	124 000	1 600	2 100

¹⁾ Fillet radius indicates maximum fillet radius on shaft or in housing which bearing corner will clear.

²⁾ Listed values are for pressed steel or polyamide cage, ABEC-1.

For phenolic composition cage, multiply by 1.66 for grease and 2.00 for oil. For machined bronze cage, multiply by 1.25 for grease and 1.50 for oil. For phenolic composition cage, ABEC-5 or 7, multiply by 2.30 for grease and 2.80 for oil. The speed rating adjustment factors have been determined through historical application and practice. For a more complete explanation, see page 276.

³⁾ Rating for one million revolutions or 500 hours at 33 1/3 RPM.

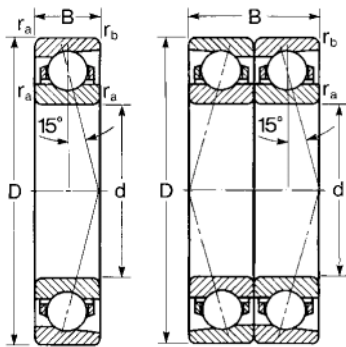

Note: ABEC 1 & 3 are stocked as half-pairs where available.

100-R Extra Large Series bearings are available in bore diameters ranging from 100 mm to 320 mm. They are used with light to moderate radial loads, one-directional thrust loads, or a combination of both. Duplex bearings should be used for two-directional thrust loads.

"D" indicates a duplex ground half pair matched with an identical half pair and is followed by an additional suffix letter to describe the type of duplex. See pages 236 and 237 for suffix description.

Values for -RD bearings are for back-to-back (DB) or face-to-face (DF) mounting arrangements.

MRC Bearing Number	Bore		Outside Diameter		Width		Fillet Radius ¹⁾					Basic Radial Load Rating				Speed Rating ²⁾		
	d	mm	D	mm	B	mm	r _a		r _b		ZD ²⁾		Dynamic C ₃₎		Static C ₀		Grease RPM	Oil RPM
							mm	in	mm	in	mm	in	N	lbf	N	lbf		
120-R	100	3.9370	160	6.2992	28	1.1024	2.0	.08	1.0	.040	6 100	9.45	95 600	21 500	95 000	21 400	3 900	4 800
122-R	110	4.3307	175	6.8898	30	1.1811	2.0	.08	1.0	.040	7 290	11.3	114 000	25 600	114 000	25 600	3 600	4 400
124-R	120	4.7244	190	7.4803	32	1.2598	2.0	.08	1.0	.040	8 970	13.9	134 000	30 100	140 000	31 500	3 300	4 000
126-R	130	5.1181	205	8.0709	34	1.3386	2.0	.08	1.0	.040	9 350	14.5	138 000	31 000	150 000	33 700	3 000	3 700
128-R	140	5.5118	220	8.6614	36	1.4173	2.0	.08	1.0	.040	10 800	16.8	157 000	35 300	173 000	38 900	2 800	3 400
130-R	150	5.9055	235	9.2520	38	1.4961	2.0	.08	1.0	.040	12 400	19.3	176 000	39 600	200 000	45 000	2 600	3 200
132-R	160	6.2992	250	9.8425	40	1.5748	2.0	.08	1.0	.040	14 200	22.0	183 000	41 100	228 000	51 300	2 500	3 000
134-R	170	6.6929	265	10.4331	42	1.6535	2.5	.10	1.0	.040	16 000	24.8	216 000	48 600	255 000	57 300	2 300	2 800
136-R	180	7.0866	280	11.0236	44	1.7323	2.5	.10	1.0	.040	17 900	27.8	233 000	52 400	285 000	64 100	2 100	2 600
138-R	190	7.4803	300	11.8110	46	1.8110	2.5	.10	1.0	.040	22 200	34.4	275 000	61 800	355 000	79 800	2 100	2 500
140-R	200	7.8740	320	12.5984	48	1.8898	2.5	.10	1.0	.040	24 400	37.9	292 000	65 600	390 000	87 700	1 900	2 300
142-R	210	8.2677	340	13.3858	50	1.9685	2.5	.10	1.0	.040	28 000	43.4	319 000	71 700	440 000	98 900	1 800	2 200
144-R	220	8.6614	350	13.7795	51	2.0079	2.5	.10	1.0	.040	29 300	45.5	336 000	75 500	465 000	105 000	1 700	2 100
146-R	230	9.0551	370	14.5669	53	2.0866	3.0	.12	1.0	.040	31 900	49.5	352 000	79 100	510 000	115 000	1 600	2 000
148-R	240	9.4488	390	15.3543	55	2.1654	3.0	.12	1.0	.040	34 600	53.7	374 000	84 100	550 000	124 000	1 600	1 900
150-R	250	9.8425	410	16.1417	57	2.2441	3.0	.12	1.0	.040	37 500	58.1	393 000	88 400	600 000	135 000	1 500	1 800
152-R	260	10.2362	430	16.9291	59	2.3228	3.0	.12	1.0	.040	40 400	62.7	413 000	92 800	655 000	147 000	1 400	1 700
156-R	280	11.0236	460	18.1102	63	2.4803	3.0	.12	1.0	.040	46 600	72.3	457 000	103 000	750 000	169 000	1 300	1 600
164-R	320	12.5984	500	19.6850	71	2.7953	3.0	.12	1.0	.040	56 800	88.0	523 000	118 000	900 000	202 000	1 100	1 400
100-RD																		
120-RD	100	3.9370	160	6.2992	56	2.2047	2.0	.08	1.0	.040	6 100	9.45	156 000	35 100	190 000	42 700	3 100	3 800
122-RD	110	4.3307	175	6.8898	60	2.3622	2.0	.08	1.0	.040	7 290	11.3	185 000	41 800	228 000	51 300	2 900	3 500
124-RD	120	4.7244	190	7.4803	64	2.5197	2.0	.08	1.0	.040	8 970	13.9	221 000	49 700	280 000	62 900	2 600	3 200
126-RD	130	5.1181	205	8.0709	68	2.6722	2.0	.08	1.0	.040	9 350	14.5	221 000	49 700	300 000	67 400	2 400	3 000
128-RD	140	5.5118	220	8.6614	72	2.8346	2.0	.08	1.0	.040	10 800	16.8	255 000	57 300	345 000	77 600	2 200	2 700
130-RD	150	5.9055	235	9.2520	76	2.9921	2.0	.08	1.0	.040	12 400	19.3	286 000	64 300	400 000	89 900	2 100	2 600
132-RD	160	6.2992	250	9.8425	80	3.1496	2.0	.08	1.0	.040	14 200	22.0	296 000	66 500	455 000	102 000	2 000	2 400
134-RD	170	6.6929	265	10.4331	84	3.3071	2.5	.10	1.0	.040	16 000	24.8	351 000	78 900	510 000	115 000	1 800	2 200
136-RD	180	7.0866	280	11.0236	88	3.4646	2.5	.10	1.0	.040	17 900	27.8	377 000	84 800	570 000	128 000	1 700	2 100
138-RD	190	7.4803	300	11.8110	92	3.6220	2.5	.10	1.0	.040	22 200	34.4	442 000	99 400	710 000	160 000	1 700	2 000
140-RD	200	7.8740	320	12.5984	96	3.7795	2.5	.10	1.0	.040	24 400	37.8	475 000	107 000	780 000	175 000	1 500	1 800
142-RD	210	8.2677	340	13.3858	100	3.9370	2.5	.10	1.0	.040	28 000	43.4	527 000	118 000	880 000	198 000	1 400	1 800
144-RD	220	8.6614	350	13.7795	102	4.0157	2.5	.10	1.0	.040	29 300	45.5	540 000	121 000	930 000	209 000	1 400	1 700
146-RD	230	9.0551	370	14.5669	106	4.1732	3.0	.12	1.0	.040	31 900	49.5	572 000	129 000	1 020 000	229 000	1 300	1 600
148-RD	240	9.4488	390	15.3543	110	4.3307	3.0	.12	1.0	.040	34 600	53.7	605 000	136 000	1 100 000	247 000	1 300	1 500
150-RD	250	9.8425	410	16.1417	114	4.4882	3.0	.12	1.0	.040	37 500	58.1	637 000	143 000	1 200 000	270 000	1 200	1 400
152-RD	260	10.2362	430	16.9291	118	4.6457	3.0	.12	1.0	.040	40 400	62.7	676 000	152 000	1 290 000	290 000	1 100	1 400
156-RD	280	11.0236	460	18.1102	126	4.9606	3.0	.12	1.0	.040	46 600	72.3	741 000	167 000	1 500 000	337 000	1 000	1 300
164-RD	320	12.5984	500	19.6850	142	5.5904	3.0	.12	1.0	.040	56 800	88.0	852 000	192 000	1 800 000	405 000	880	1 100

¹⁾ Fillet radius indicates maximum fillet radius on shaft or in housing which bearing corner will clear.

²⁾ Listed values are for pressed steel or polyamide cage, ABEC-1.

For phenolic composition cage, multiply by 1.66 for grease and 2.00 for oil. For machined bronze cage, multiply by 1.25 for grease and 1.50 for oil. For phenolic composition cage, ABEC-5 or 7, multiply by 2.30 for grease and 2.80 for oil. The speed rating adjustment factors have been determined through historical application and practice. For a more complete explanation, see page 276.

³⁾ Rating for one million revolutions or 500 hours at 33 1/3 RPM.

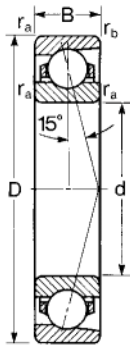

100-KR Extra Light Series bearings are made with bores ranging from 10 mm to 320 mm. 100-KR bearings can accommodate light to moderate radial loads or one-directional thrust loads, or a combination of both where space is somewhat limited. They can be furnished duplex-ground for mounting in pairs. Duplex bearings should be used for two-directional thrust loads.

MRC Bearing Number	Bore d		Outside Diameter D		Width B		Fillet Radius ¹⁾					Basic Radial Load Rating				Speed Rating ²⁾		
												Dynamic C _d ³⁾		Static C ₀		Grease RPM	Oil RPM	
												N	lbf	N	lbf			
100-KR	10	.3937	26	1.0236	8	.3150	.30	.012	.10	.004	181	.28	4 940	1 110	2 280	513	30 000	36 000
101-KR	12	.4724	28	1.1024	8	.3150	.30	.012	.10	.004	206	.32	5 530	1 240	2 650	596	26 000	32 000
102-KR	15	.5906	32	1.2598	9	.3543	.30	.012	.10	.004	226	.35	6 050	1 350	3 150	708	22 000	28 000
103-KR	17	.6693	35	1.3780	10	.3937	.30	.012	.10	.004	342	.53	8 520	1 920	4 650	1 050	19 000	24 000
104-KR	20	.7874	42	1.6535	12	.4724	.64	.025	.30	.012	445	.69	10 800	2 420	6 200	1 390	17 000	20 000
105-KR	25	.9843	47	1.8504	12	.4724	.64	.025	.30	.012	522	.81	12 100	2 720	7 650	1 720	15 000	18 000
106-KR	30	1.1811	55	2.1654	13	.5118	1.0	.04	.30	.012	716	1.11	15 600	3 500	10 600	2 380	12 000	15 000
107-KR	35	1.3780	62	2.4409	14	.5512	1.0	.04	.30	.012	884	1.37	18 600	4 180	13 200	2 970	10 000	13 000
108-KR	40	1.5748	68	2.6772	15	.5906	1.0	.04	.30	.012	942	1.46	19 500	4 380	14 600	3 280	9 500	12 000
109-KR	45	1.7717	75	2.9528	16	.6299	1.0	.04	.30	.012	1 220	1.89	24 200	5 440	19 000	4 270	9 000	11 000
110-KR	50	1.9685	80	3.1496	16	.6299	1.0	.04	.30	.012	1 300	2.01	25 100	5 640	20 400	4 590	8 500	10 000
111-KR	55	2.1654	90	3.5433	18	.7087	1.0	.04	.60	.024	1 810	2.81	33 800	7 600	28 000	6 290	7 500	9 000
112-KR	60	2.3622	95	3.7402	18	.7087	1.0	.04	.60	.024	1 920	2.97	35 100	7 890	30 000	6 740	6 700	8 000
113-KR	65	2.5591	100	3.9370	18	.7087	1.0	.04	.60	.024	2 030	3.14	35 800	8 050	32 500	7 310	6 300	7 500
114-KR	70	2.7559	110	4.3307	20	.7874	1.0	.04	.60	.024	2 470	3.83	42 300	9 510	40 000	8 990	6 000	7 000
115-KR	75	2.9528	115	4.5276	20	.7874	1.0	.04	.60	.024	2 590	4.02	43 600	9 800	42 500	9 550	5 600	6 770
116-KR	80	3.1496	125	4.9213	22	.8661	1.0	.04	.60	.024	3 390	5.25	55 900	12 600	54 000	12 100	5 300	6 300
117-KR	85	3.3465	130	5.1181	22	.8661	1.0	.04	.60	.024	3 550	5.50	57 200	12 900	57 000	12 800	5 000	6 000
118-KR	90	3.5433	140	5.5118	24	.9449	1.5	.06	.60	.024	4 280	6.64	68 900	15 500	68 000	15 300	4 800	5 600
119-KR	95	3.7402	145	5.7087	24	.9449	1.5	.06	.60	.024	5 040	7.81	83 200	18 700	80 000	18 000	4 500	5 300
120-KR	100	3.9370	150	5.9055	24	.9449	1.5	.06	.60	.024	4 700	7.28	71 500	16 100	76 500	17 200	4 300	5 000
121-KR	105	4.1339	160	6.2992	26	1.0236	2.0	.08	1.0	.040	5 540	8.59	85 200	19 200	90 000	20 200	4 000	4 800
122-KR	110	4.3307	170	6.6929	28	1.1024	2.0	.08	1.0	.040	6 400	9.93	99 500	22 400	102 000	23 000	3 800	4 500
124-KR	120	4.7244	180	7.0866	28	1.1024	2.0	.08	1.0	.040	6 710	10.4	101 000	22 600	110 000	24 700	3 400	4 000
126-KR	130	5.1181	200	7.8740	33	1.2992	2.0	.08	1.0	.040	9 350	14.5	138 000	31 000	150 000	33 700	3 200	3 800
128-KR	140	5.5118	210	8.2677	33	1.2992	2.0	.08	1.0	.040	9 350	14.5	135 000	30 300	153 000	34 400	3 000	3 600
130-KR	150	5.9055	225	8.8583	35	1.3780	2.0	.08	1.0	.040	10 800	16.8	156 000	35 000	176 000	39 600	2 600	3 200
132-KR	160	6.2992	240	9.4488	38	1.4961	2.0	.08	1.0	.040	12 400	18.3	178 000	40 000	204 000	45 900	2 400	3 000
134-KR	170	6.6929	260	10.2362	42	1.6535	2.0	.08	1.0	.040	15 300	23.7	212 000	47 700	245 000	55 100	2 200	2 800
136-KR	180	7.0866	280	11.0236	46	1.8110	2.0	.08	1.0	.040	17 900	27.8	234 000	52 600	290 000	65 200	2 000	2 600
138-KR	190	7.4803	290	11.4173	46	1.8110	2.0	.08	1.0	.040	18 800	29.1	242 000	54 400	305 000	68 600	2 000	2 600
140-KR	200	7.8740	310	12.2047	51	2.0079	2.0	.08	1.0	.040	22 200	34.4	276 000	62 000	355 000	79 800	1 900	2 400
144-KR	220	8.6614	340	13.3858	56	2.2047	2.5	.10	1.0	.040	30 400	47.2	345 000	77 600	480 000	108 000	1 800	2 200
148-KR	240	9.4488	360	14.1732	56	2.2047	2.5	.10	1.0	.040	31 900	49.5	351 000	78 900	510 000	115 000	1 700	2 000
152-KR	260	10.2362	400	15.7480	65	2.5591	3.0	.12	1.5	.060	41 500	64.3	423 000	95 100	655 000	147 000	1 500	1 800
156-KR	280	11.0236	420	16.5354	65	2.5591	3.0	.12	1.5	.060	43 500	67.4	436 000	98 000	695 000	156 000	1 400	1 700
160-KR	300	11.8110	460	18.1102	74	2.9134	3.0	.12	1.5	.060	54 200	84.0	520 000	117 000	850 000	191 000	1 200	1 500
164-KR	320	12.5984	480	18.8976	74	2.9134	3.0	.12	1.5	.060	56 800	88.0	527 000	118 000	900 000	202 000	1 100	1 400

¹⁾ Fillet radius indicates maximum fillet radius on shaft or in housing which bearing corner will clear.

²⁾ Listed values are for pressed steel or polyamide cage, ABEC-1.

For phenolic composition cage, multiply by 1.66 for grease and 2.00 for oil. For machined bronze cage, multiply by 1.25 for grease and 1.50 for oil. For phenolic composition cage, ABEC-5 or 7, multiply by 2.30 for grease and 2.80 for oil. The speed rating adjustment factors have been determined through historical application and practice. For a more complete explanation, see page 276.

³⁾ Rating for one million revolutions or 500 hours at 33½ RPM.

100-KRD

Extra Light Series, Duplex

MRC Bearing Services

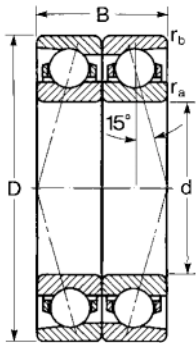

"D" indicates a duplex ground half pair matched with an identical half pair and is followed by an additional suffix letter to describe the type of duplex. See pages 236 and 237 for suffix description.

Note: ABEC 1 & 3 are stocked as half-pairs where available

Use these values for back-to-back (DB) or face-to-face (DF) mounting arrangements

MRC Bearing Number	Bore		Outside Diameter		Width		Fillet Radius ¹⁾					Basic Radial Load Rating				Speed Rating ²⁾		
	d	in	D	in	B	in	r _a		r _b		ZD ²⁾		Dynamic C ₃₎		Static C ₀		Grease RPM	Oil RPM
							mm	in	mm	in	mm	in	mm	in	N	lbf		
100-KRD	10	.3937	26	1.0236	16	.6299	.30	.012	.10	.004	181	.28	8 060	1 810	4 550	1 020	24 000	29 000
101-KRD	12	.4724	28	1.1024	16	.6299	.30	.012	.10	.004	206	.32	8 840	1 990	5 300	1 190	21 000	26 000
102-KRD	15	.5906	32	1.2598	18	.7087	.30	.012	.10	.004	226	.35	9 750	2 190	6 300	1 420	18 000	22 000
103-KRD	17	.6693	35	1.3780	20	.7874	.30	.012	.10	.004	342	.53	13 800	3 100	9 300	2 090	15 000	19 000
104-KRD	20	.7874	42	1.6535	24	.9449	.64	.025	.30	.012	445	.69	17 400	3 910	12 500	2 810	14 000	16 000
105-KRD	25	.9843	47	1.8504	24	.9449	.64	.025	.30	.012	522	.81	19 500	4 380	15 300	3 440	12 000	14 000
106-KRD	30	1.1811	55	2.1654	26	1.0236	1.0	.04	.30	.012	716	1.11	25 500	5 730	21 200	4 760	9 600	12 000
107-KRD	35	1.3780	62	2.4409	28	1.1024	1.0	.04	.30	.012	884	1.37	30 200	6 790	26 500	5 960	8 000	10 000
108-KRD	40	1.5748	68	2.6772	30	1.1811	1.0	.04	.30	.012	942	1.46	31 900	7 170	29 000	6 520	7 600	9 600
109-KRD	45	1.7717	75	2.9528	32	1.2598	1.0	.04	.30	.012	1 220	1.89	39 000	8 770	37 500	8 430	7 200	8 800
110-KRD	50	1.9685	80	3.1496	32	1.2598	1.0	.04	.30	.012	1 300	2.01	40 300	9 060	40 500	9 100	6 800	8 000
111-KRD	55	2.1654	90	3.5433	36	1.4173	1.0	.04	.60	.024	1 810	2.81	55 300	12 400	56 000	12 600	6 000	7 200
112-KRD	60	2.3622	95	3.7402	36	1.4173	1.0	.04	.60	.024	1 820	2.97	55 900	12 600	61 000	13 700	5 400	6 400
113-KRD	65	2.5591	100	3.9370	36	1.4173	1.0	.04	.60	.024	2 030	3.14	58 500	13 200	64 000	14 400	5 000	6 000
114-KRD	70	2.7559	110	4.3307	40	1.5748	1.0	.04	.60	.024	2 470	3.83	68 900	15 500	80 000	18 000	4 800	5 600
115-KRD	75	2.9528	115	4.5276	40	1.5748	1.0	.04	.60	.024	2 590	4.02	70 200	15 800	85 000	19 100	4 500	5 400
116-KRD	80	3.1496	125	4.9213	44	1.7323	1.0	.04	.60	.024	3 390	5.25	90 400	20 300	110 000	24 700	4 200	5 000
117-KRD	85	3.3465	130	5.1181	44	1.7323	1.0	.04	.60	.024	3 550	5.50	92 300	20 700	116 000	26 100	4 000	4 800
118-KRD	90	3.5433	140	5.5118	48	1.8898	1.5	.06	.60	.024	4 280	6.64	111 000	25 000	137 000	30 800	3 800	4 500
119-KRD	95	3.7402	145	5.7087	48	1.8898	1.5	.06	.60	.024	5 040	7.81	135 000	30 300	160 000	36 000	3 600	4 200
120-KRD	100	3.9370	150	5.9055	48	1.8898	1.5	.06	.60	.024	4 700	7.28	117 000	26 300	153 000	34 400	3 400	4 000
121-KRD	105	4.1339	160	6.2992	52	2.0472	2.0	.08	1.0	.040	5 540	8.59	138 000	31 000	180 000	40 500	3 200	3 800
122-KRD	110	4.3307	170	6.6929	56	2.2047	2.0	.08	1.0	.040	6 400	9.93	163 000	36 600	204 000	45 900	3 000	3 600
124-KRD	120	4.7244	180	7.0866	56	2.2047	2.0	.08	1.0	.040	6 710	10.4	163 000	36 600	220 000	49 500	2 700	3 200
126-KRD	130	5.1181	200	7.8740	66	2.5984	2.0	.08	1.0	.040	9 350	14.5	225 000	50 000	300 000	67 400	2 600	3 000
128-KRD	140	5.5118	210	8.2677	66	2.5984	2.0	.08	1.0	.040	9 850	14.5	221 000	49 700	305 000	68 600	2 400	2 900
130-KRD	150	5.9055	225	8.8583	70	2.7559	2.0	.08	1.0	.040	10 800	16.8	255 000	57 300	355 000	79 800	2 100	2 600
132-KRD	160	6.2992	240	9.4488	76	2.9921	2.0	.08	1.0	.040	12 400	18.3	286 000	64 300	405 000	91 000	1 900	2 400
134-KRD	170	6.6929	260	10.2362	84	3.3071	2.0	.08	1.0	.040	15 300	23.7	345 000	77 600	490 000	110 000	1 800	2 200
136-KRD	180	7.0866	280	11.0236	92	3.6220	2.0	.08	1.0	.040	17 900	27.8	377 000	84 800	570 000	128 000	1 600	2 100
138-KRD	190	7.4803	290	11.4173	92	3.6220	2.0	.08	1.0	.040	18 800	29.1	390 000	87 700	610 000	137 000	1 600	2 100
140-KRD	200	7.8740	310	12.2047	102	4.0157	2.0	.08	1.0	.040	22 200	34.4	442 000	99 400	710 000	160 000	1 500	1 900
144-KRD	220	8.6614	340	13.3858	112	4.4094	2.5	.10	1.0	.040	30 400	47.2	559 000	126 000	965 000	217 000	1 400	1 800
148-KRD	240	9.4488	360	14.1732	112	4.4094	2.5	.10	1.0	.040	31 900	49.5	572 000	129 000	1 020 000	228 000	1 400	1 600
152-KRD	260	10.2362	400	15.7480	130	5.1181	3.0	.12	1.5	.060	41 500	64.3	702 000	158 000	1 320 000	297 000	1 200	1 400
156-KRD	280	11.0236	420	16.5354	130	5.1181	3.0	.12	1.5	.060	43 500	67.4	715 000	161 000	1 400 000	315 000	1 100	1 400
160-KRD	300	11.8110	460	18.1102	148	5.8268	3.0	.12	1.5	.060	54 200	84.0	832 000	187 000	1 700 000	382 000	960	1 200
164-KRD	320	12.5984	480	18.8976	148	5.8268	3.0	.12	1.5	.060	56 800	88.0	852 000	192 000	1 810 000	406 000	880	1 100

¹⁾ Fillet radius indicates maximum fillet radius on shaft or in housing which bearing corner will clear.

²⁾ Listed values are for pressed steel or polyamide cage, ABEC-1.

For phenolic composition cage, multiply by 1.66 for grease and 2.00 for oil. For machined bronze cage, multiply by 1.25 for grease and 1.50 for oil. For phenolic composition cage, ABEC-5 or 7, multiply by 2.30 for grease and 2.80 for oil. The speed rating adjustment factors have been determined through historical application and practice. For a more complete explanation, see page 276.

³⁾ Rating for one million revolutions or 500 hours at 33 1/3 RPM.

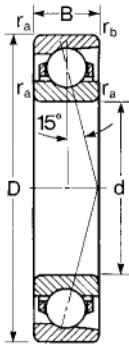

200-R Light Series bearings are made with bore diameters ranging from 10 mm to 320 mm. These bearings are recommended for moderate to heavy radial loads, for heavy thrust loads in one direction, or for combinations of both. Duplex bearings should be used for two-directional thrust loads.

MRC Bearing Number	Bore d mm in		Outside Diameter D mm in		Width B mm in		Fillet Radius ¹⁾ ZD ²⁾					Basic Radial Load Rating				Speed Rating ²⁾		
												Dynamic C ₃₎		Static C ₀		Grease RPM	Oil RPM	
												N	lbf	N	lbf			
200-R	10	.3937	30	1.1811	9	.3543	.64	.025	.30	.012	284	.44	7 280	1 640	3 200	719	24 000	30 000
201-R	12	.4724	32	1.2598	10	.3937	.64	.025	.30	.012	323	.50	8 190	1 840	3 900	877	22 000	28 000
202-R	15	.5906	35	1.3780	11	.4331	.64	.025	.30	.012	406	.63	9 750	2 190	5 100	1 150	19 000	24 000
203-R	17	.6693	40	1.5748	12	.4724	.64	.025	.30	.012	510	.79	12 100	2 730	6 550	1 470	17 000	20 000
204-R	20	.7874	47	1.8504	14	.5512	1.0	.04	.60	.024	613	.95	14 000	3 150	8 500	1 910	15 000	18 000
205-R	25	.9843	52	2.0472	15	.5906	1.0	.04	.60	.024	755	1.17	16 800	3 780	10 600	2 380	12 000	15 000
206-R	30	1.1811	62	2.4409	16	.6299	1.0	.04	.60	.024	884	1.37	19 000	4 270	12 900	2 910	10 000	13 000
207-R	35	1.3780	72	2.8346	17	.6693	1.0	.04	.60	.024	1 270	1.97	26 000	5 850	18 600	4 180	9 000	11 000
208-R	40	1.5748	80	3.1496	18	.7087	1.0	.04	.60	.024	1 730	2.68	34 500	7 760	25 000	5 620	8 500	10 000
209-R	45	1.7717	85	3.3465	19	.7480	1.0	.04	.60	.024	1 730	2.68	34 500	7 760	25 500	5 730	7 500	9 000
210-R	50	1.9685	90	3.5433	20	.7874	1.0	.04	.60	.024	1 910	3.06	37 700	8 480	30 000	6 740	7 000	8 500
211-R	55	2.1654	100	3.9370	21	.8268	1.5	.06	1.0	.040	2 860	4.43	54 000	12 100	41 500	9 330	6 300	7 500
212-R	60	2.3622	110	4.3307	22	.8661	1.5	.06	1.0	.040	3 260	5.06	59 200	13 300	49 000	11 000	6 000	7 000
213-R	65	2.5591	120	4.7244	23	.9055	1.5	.06	1.0	.040	4 030	6.25	60 500	13 600	58 500	13 200	5 300	6 300
214-R	70	2.7559	125	4.9213	24	.9449	1.5	.06	1.0	.040	4 530	7.03	78 000	17 500	68 000	15 300	5 000	6 000
215-R	75	2.9528	130	5.1181	25	.9843	1.5	.06	1.0	.040	5 190	8.04	88 400	19 900	76 500	17 200	4 800	5 600
216-R	80	3.1496	140	5.5118	26	1.0236	2.0	.08	1.0	.040	4 880	7.57	85 200	19 200	73 500	16 500	4 500	5 300
217-R	85	3.3465	150	5.9055	28	1.1024	2.0	.08	1.0	.040	6 170	9.56	104 000	23 400	93 000	20 900	4 300	5 000
218-R	90	3.5433	160	6.2992	30	1.1811	2.0	.08	1.0	.040	7 870	12.2	130 000	29 200	116 000	26 100	3 800	4 500
219-R	95	3.7402	170	6.6929	32	1.2598	2.0	.08	1.0	.040	8 390	13.0	138 000	31 000	125 000	28 000	3 600	4 300
220-R	100	3.9370	180	7.0866	34	1.3386	2.0	.08	1.0	.040	9 610	14.9	153 000	34 000	143 000	32 100	3 400	4 000
221-R	105	4.1339	190	7.4803	36	1.4173	2.0	.08	1.0	.040	10 300	16.0	168 000	37 800	153 000	34 400	3 200	3 800
222-R	110	4.3307	200	7.8740	38	1.4961	2.0	.08	1.0	.040	11 700	18.1	182 000	40 900	170 000	38 200	3 000	3 600
224-R	120	4.7244	215	8.4646	40	1.5748	2.0	.08	1.0	.040	13 000	20.2	199 000	44 700	193 000	43 300	2 800	3 400
226-R	130	5.1181	230	9.0551	40	1.5748	2.5	.10	1.0	.040	15 500	24.0	221 000	49 600	232 000	52 200	2 600	3 200
228-R	140	5.5118	250	9.8425	42	1.6535	2.5	.10	1.0	.040	17 200	26.6	238 000	53 500	260 000	58 500	2 400	2 900
230-R	150	5.9055	270	10.6299	45	1.7717	2.5	.10	1.0	.040	20 700	32.1	270 000	60 700	310 000	69 700	2 200	2 700
232-R	160	6.2992	290	11.4173	48	1.8898	2.5	.10	1.0	.040	24 600	38.2	307 000	69 000	365 000	82 100	2 100	2 500
234-R	170	6.6929	310	12.2047	52	2.0472	3.0	.12	1.0	.040	27 200	42.2	332 000	74 600	400 000	89 900	1 900	2 300
236-R	180	7.0866	320	12.5984	52	2.0472	3.0	.12	1.0	.040	29 000	44.9	345 000	77 600	430 000	96 700	1 800	2 200
238-R	190	7.4803	340	13.3858	55	2.1654	3.0	.12	1.0	.040	33 100	51.3	377 000	84 800	500 000	112 000	1 700	2 100
240-R	200	7.8740	360	14.1732	58	2.2835	3.0	.12	1.0	.040	35 500	55.1	390 000	87 700	540 000	121 000	1 600	2 000
242-R	210	8.2677	380	14.9606	61	2.4016	3.0	.12	1.0	.040	40 800	63.3	436 000	98 000	610 000	137 000	1 600	1 900
244-R	220	8.6614	400	15.7480	65	2.5591	3.0	.12	1.0	.040	43 900	68.0	462 000	104 000	655 000	147 000	1 500	1 800
246-R	230	9.0551	420	16.5354	68	2.6772	3.0	.12	1.0	.040	49 500	76.8	494 000	111 000	735 000	165 000	1 400	1 700
248-R	240	9.4488	440	17.3228	72	2.8346	3.0	.12	1.0	.040	55 500	86.1	540 000	121 000	830 000	187 000	1 300	1 600
250-R	250	9.8425	460	18.1102	76	2.9921	4.0	.16	1.5	.060	61 900	95.9	585 000	132 000	915 000	206 000	1 200	1 500
252-R	260	10.2362	480	18.8976	80	3.1496	4.0	.16	1.5	.060	68 400	106	624 000	140 000	1 020 000	229 000	1 100	1 400
256-R	280	11.0236	500	19.6850	80	3.1496	4.0	.16	1.5	.060	72 200	112	650 000	146 000	1 100 000	247 000	1 100	1 400
260-R	300	11.8110	540	21.2598	85	3.3465	4.0	.16	1.5	.060	80 000	124	689 000	155 000	1 220 000	274 000	1 100	1 300
264-R	320	12.5984	580	22.8346	92	3.6220	4.0	.16	1.5	.060	87 700	136	741 000	167 000	1 340 000	301 000	980	1 200

¹⁾ Fillet radius indicates maximum fillet radius on shaft or in housing which bearing corner will clear.

²⁾ Listed values are for pressed steel or polyamide cage, ABEC-1.

For phenolic composition cage, multiply by 1.66 for grease and 2.00 for oil. For machined bronze cage, multiply by 1.25 for grease and 1.50 for oil. For phenolic composition cage, ABEC-5 or 7, multiply by 2.30 for grease and 2.80 for oil. The speed rating adjustment factors have been determined through historical application and practice. For a more complete explanation, see page 276.

³⁾ Rating for one million revolutions or 500 hours at 33 1/3 RPM.

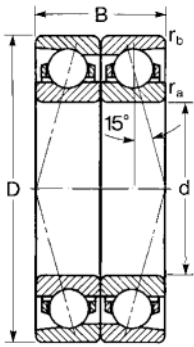

"D" indicates a duplex ground half pair matched with an identical half pair and is followed by an additional suffix letter to describe the type of duplex. See pages 236 and 237 for suffix description.

Note: ABEC 1 & 3 are stocked as half-pairs where available

Use these values for back-to-back (DB) or face-to-face (DF) mounting arrangements

MRC Bearing Number	Bore		Outside Diameter		Width		Fillet Radius ¹⁾					Basic Radial Load Rating				Speed Rating ²⁾		
	d	mm	D	mm	B	mm	r _a		r _b		ZD ²⁾		Dynamic C ₃₎		Static C ₀		Grease RPM	Oil RPM
							mm	in	mm	in	mm	in	N	lbf	N	lbf		
200-RD	10	.3937	30	1.1811	18	.7087	.64	.025	.30	.012	284	.44	11 900	2 670	6 400	1 440	19 000	24 000
201-RD	12	.4724	32	1.2598	20	.7874	.64	.025	.30	.012	323	.50	13 300	2 990	7 800	1 750	18 000	22 000
202-RD	15	.5906	35	1.3780	22	.8661	.64	.025	.30	.012	406	.63	15 900	3 580	10 200	2 290	15 000	19 000
203-RD	17	.6693	40	1.5748	24	.9449	.64	.025	.30	.012	510	.79	19 900	4 470	13 200	2 970	14 000	16 000
204-RD	20	.7874	47	1.8504	28	1.1024	1.0	.04	.60	.024	613	.95	22 900	5 140	17 000	3 820	12 000	14 000
205-RD	25	.9843	52	2.0472	30	1.1811	1.0	.04	.60	.024	755	1.17	27 600	6 200	21 200	4 770	9 600	12 000
206-RD	30	1.1811	62	2.4409	32	1.2598	1.0	.04	.60	.024	884	1.37	30 700	6 900	26 000	5 850	8 000	10 000
207-RD	35	1.3780	72	2.8346	34	1.3386	1.0	.04	.60	.024	1 270	1.97	42 300	9 510	37 500	8 430	7 200	8 800
208-RD	40	1.5748	80	3.1496	36	1.4173	1.0	.04	.60	.024	1 730	2.68	55 900	12 600	50 000	11 200	6 800	8 000
209-RD	45	1.7717	85	3.3465	38	1.4961	1.0	.04	.60	.024	1 730	2.68	55 900	12 600	51 000	11 500	6 000	7 200
210-RD	50	1.9685	90	3.5433	40	1.5748	1.0	.04	.60	.024	1 970	3.06	60 500	13 600	60 000	13 500	5 600	6 800
211-RD	55	2.1654	100	3.9370	42	1.6535	1.5	.06	1.0	.040	2 860	4.43	88 400	19 900	83 000	18 700	5 000	6 000
212-RD	60	2.3622	110	4.3307	44	1.7323	1.5	.06	1.0	.040	3 260	5.06	95 600	21 500	96 500	21 700	4 800	5 600
213-RD	65	2.5591	120	4.7244	46	1.8110	1.5	.06	1.0	.040	4 030	6.25	97 500	21 900	118 000	26 500	4 200	5 000
214-RD	70	2.7559	125	4.9213	48	1.8898	1.5	.06	1.0	.040	4 530	7.03	125 000	28 200	137 000	30 800	4 000	4 800
215-RD	75	2.9528	130	5.1181	50	1.9685	1.5	.06	1.0	.040	5 190	8.04	143 000	32 100	153 000	34 400	3 800	4 500
216-RD	80	3.1496	140	5.5118	52	2.0472	2.0	.08	1.0	.040	4 880	7.57	138 000	31 000	140 000	31 500	3 600	4 200
217-RD	85	3.3465	150	5.9055	56	2.2047	2.0	.08	1.0	.040	6 170	9.56	168 000	37 700	186 000	41 800	3 400	4 000
218-RD	90	3.5433	160	6.2992	60	2.3622	2.0	.08	1.0	.040	7 870	12.2	212 000	47 700	232 000	52 200	3 000	3 600
219-RD	95	3.7402	170	6.6929	64	2.5197	2.0	.08	1.0	.040	8 390	13.0	221 000	49 700	250 000	56 200	2 900	3 400
220-RD	100	3.9370	180	7.0866	68	2.6772	2.0	.08	1.0	.040	9 610	14.9	251 000	56 400	285 000	64 100	2 700	3 200
221-RD	105	4.1339	190	7.4803	72	2.8346	2.0	.08	1.0	.040	10 300	16.0	270 000	60 700	305 000	68 600	2 600	3 000
222-RD	110	4.3307	200	7.8740	76	2.9921	2.0	.08	1.0	.040	11 700	18.1	296 000	66 500	340 000	76 400	2 400	2 900
224-RD	120	4.7244	215	8.4646	80	3.1496	2.0	.08	1.0	.040	13 000	20.2	319 000	71 800	390 000	87 700	2 200	2 700
226-RD	130	5.1181	230	9.0551	80	3.1496	2.5	.10	1.0	.040	15 500	24.0	358 000	80 500	455 000	102 000	2 100	2 600
228-RD	140	5.5118	250	9.8425	84	3.3071	2.5	.10	1.0	.040	17 200	26.6	390 000	87 700	510 000	115 000	1 900	2 300
230-RD	150	5.9055	270	10.6299	90	3.5433	2.5	.10	1.0	.040	20 700	32.1	442 000	99 400	620 000	139 000	1 800	2 200
232-RD	160	6.2992	290	11.4173	96	3.7795	2.5	.10	1.0	.040	24 600	38.7	494 000	111 000	735 000	165 000	1 700	2 000
234-RD	170	6.6929	310	12.2047	104	4.0945	3.0	.12	1.0	.040	27 200	42.2	527 000	118 000	800 000	180 000	1 500	1 800
236-RD	180	7.0866	320	12.5984	104	4.0945	3.0	.12	1.0	.040	29 000	44.9	559 000	126 000	865 000	194 000	1 400	1 800
238-RD	190	7.4803	340	13.3858	110	4.3307	3.0	.12	1.0	.040	33 100	51.3	605 000	136 000	1 000 000	225 000	1 400	1 700
240-RD	200	7.8740	360	14.1732	116	4.5669	3.0	.12	1.0	.040	35 500	55.1	637 000	143 000	1 080 000	243 000	1 300	1 600
242-RD	210	8.2677	380	14.9606	122	4.8031	3.0	.12	1.0	.040	40 800	63.3	702 000	158 000	1 220 000	274 000	1 300	1 500
244-RD	220	8.6614	400	15.7480	130	5.1181	3.0	.12	1.0	.040	43 900	63.0	741 000	167 000	1 320 000	297 000	1 200	1 400
246-RD	230	9.0551	420	16.5354	136	5.3543	3.0	.12	1.0	.040	49 500	76.8	806 000	181 000	1 500 000	337 000	1 100	1 400
248-RD	240	9.4488	440	17.3228	144	5.6693	3.0	.12	1.0	.040	55 500	86.1	871 000	196 000	1 660 000	373 000	1 000	1 300
250-RD	250	9.8425	460	18.1102	152	5.9842	4.0	.16	1.5	.060	61 900	95.9	956 000	215 000	1 830 000	411 000	960	1 200
252-RD	260	10.2362	480	18.8976	160	6.2992	4.0	.16	1.5	.060	68 400	106.0	1 010 000	227 000	2 040 000	459 000	880	1 100
256-RD	280	11.0236	500	19.6850	160	6.2992	4.0	.16	1.5	.060	72 200	112.0	1 060 000	238 000	2 200 000	495 000	880	1 100
260-RD	300	11.8110	540	21.2598	170	6.6929	4.0	.16	1.5	.060	80 000	124.0	1 140 000	256 000	2 400 000	540 000	880	1 000
264-RD	320	12.5984	580	22.8346	184	7.2441	4.0	.16	1.5	.060	87 700	136.0	1 210 000	272 000	2 700 000	607 000	780	960

¹⁾ Fillet radius indicates maximum fillet radius on shaft or in housing which bearing corner will clear.

²⁾ Listed values are for pressed steel or polyamide cage, ABEC-1.

For phenolic composition cage, multiply by 1.66 for grease and 2.00 for oil. For machined bronze cage, multiply by 1.25 for grease and 1.50 for oil. For phenolic composition cage, ABEC-5 or 7, multiply by 2.30 for grease and 2.80 for oil. The speed rating adjustment factors have been determined through historical application and practice. For a more complete explanation, see page 276.

³⁾ Rating for one million revolutions or 500 hours at 33 1/3 RPM.

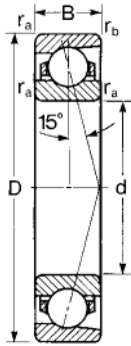

300-R Medium Series bearing bores range in diameter from 12 mm to 280 mm. They are used with heavy radial loads, one-directional thrust loads, or a combination of both. They can be furnished duplex ground for mounting in pairs with two-directional thrust loads.

MRC Bearing Number	Bore d mm in		Outside Diameter D mm in		Width B mm in		Fillet Radius ¹⁾ r _a r _b ZD ²⁾ mm in mm in mm in					Basic Radial Load Rating				Speed Rating ²⁾		
												Dynamic C ₃₎		Static C ₀		Grease RPM	Oil RPM	
												N	lbf	N	lbf			
301-R	12	.4724	37	1.4567	12	.4727	1.0	.04	.60	.024	439	.68	10 600	2 380	4 900	1 100	19 000	24 000
302-R	15	.5906	42	1.6535	13	.5118	1.0	.04	.60	.024	510	.79	12 100	2 720	6 550	1 470	17 000	20 000
303-R	17	.6693	47	1.8504	14	.5512	1.0	.04	.60	.024	632	.98	14 800	3 330	8 150	1 830	16 000	19 000
304-R	20	.7874	52	2.0472	15	.5906	1.0	.04	.60	.024	909	1.41	20 300	4 560	11 400	2 560	13 000	16 000
305-R	25	.9843	62	2.4409	17	.6693	1.0	.04	.60	.024	1 090	1.69	23 400	5 260	15 300	3 440	11 000	14 000
306-R	30	1.1811	72	2.8346	19	.7480	1.0	.04	.60	.024	1 480	2.30	31 200	7 010	20 000	4 500	9 000	11 000
307-R	35	1.3780	80	3.1496	21	.8268	1.5	.06	1.0	.040	1 940	3.00	39 700	8 920	26 000	5 850	8 500	10 000
308-R	40	1.5748	90	3.5433	23	.9055	1.5	.06	1.0	.040	2 450	3.80	48 800	11 000	33 500	7 530	7 500	9 000
309-R	45	1.7717	100	3.9370	25	.9843	1.5	.06	1.0	.040	3 030	4.69	58 500	13 200	40 500	9 100	6 700	8 000
310-R	50	1.9685	110	4.3307	27	1.0630	2.0	.08	1.0	.040	4 350	6.75	80 600	18 100	57 000	12 800	6 300	7 500
311-R	55	2.1654	120	4.7244	29	1.1417	2.0	.08	1.0	.040	5 110	7.92	93 600	21 000	67 000	15 100	5 600	6 700
312-R	60	2.3622	130	5.1181	31	1.2205	2.0	.08	1.0	.040	5 930	9.19	108 000	24 300	78 000	17 500	5 000	6 000
313-R	65	2.5591	140	5.5118	33	1.2992	2.0	.08	1.0	.040	6 900	10.7	121 000	27 200	93 000	20 900	4 800	5 600
314-R	70	2.7559	150	5.9055	35	1.3780	2.0	.08	1.0	.040	6 770	10.5	121 000	27 200	93 000	20 900	4 500	5 300
315-R	75	2.9528	160	6.2992	37	1.4567	2.0	.08	1.0	.040	9 030	14.0	153 000	34 400	122 000	27 400	4 300	5 000
316-R	80	3.1496	170	6.6929	39	1.5354	2.0	.08	1.0	.040	9 480	14.7	159 000	35 700	129 000	29 000	3 800	4 500
317-R	85	3.3465	180	7.0866	41	1.6142	2.5	.10	1.0	.040	11 400	17.7	182 000	40 900	156 000	35 100	3 600	4 300
318-R	90	3.5433	190	7.4803	43	1.6929	2.5	.10	1.0	.040	11 800	18.3	186 000	41 800	160 000	36 000	3 400	4 000
319-R	95	3.7402	200	7.8740	45	1.7717	2.5	.10	1.0	.040	13 100	20.3	199 000	44 700	180 000	40 500	3 200	3 800
320-R	100	3.9370	215	8.4646	47	1.8504	2.5	.10	1.0	.040	14 400	22.4	212 000	47 700	200 000	45 000	3 000	3 600
321-R	105	4.1339	225	8.8583	49	1.9291	2.5	.10	1.0	.040	15 900	24.6	229 000	51 500	204 000	45 900	2 800	3 400
322-R	110	4.3307	240	9.4488	50	1.9685	2.5	.10	1.0	.040	18 800	29.2	255 000	57 300	255 000	57 300	2 600	3 200
324-R	120	4.7244	260	10.2362	55	2.1654	2.5	.10	1.0	.040	22 100	34.3	265 000	59 600	300 000	67 400	2 500	3 000
326-R	130	5.1181	280	11.0236	58	2.2835	3.0	.12	1.0	.040	25 700	39.8	296 000	66 500	345 000	77 600	2 300	2 800
328-R	140	5.5118	300	11.8110	62	2.4409	3.0	.12	1.0	.040	29 500	45.7	351 000	78 900	400 000	89 900	2 100	2 600
330-R	150	5.9055	320	12.5984	65	2.5591	3.0	.12	1.0	.040	33 900	52.6	390 000	87 700	475 000	107 000	2 000	2 400
332-R	160	6.2992	340	13.3858	68	2.6772	3.0	.12	1.0	.040	38 400	59.6	423 000	95 100	530 000	119 000	1 800	2 200
334-R	170	6.6929	360	14.1732	72	2.8346	3.0	.12	1.0	.040	40 800	63.2	436 000	98 000	570 000	128 000	1 700	2 100
336-R	180	7.0866	380	14.9606	75	2.9528	3.0	.12	1.0	.040	45 700	70.9	475 000	107 000	640 000	144 000	1 600	2 000
338-R	190	7.4803	400	15.7480	78	3.0709	4.0	.16	1.5	.060	51 000	79.0	507 000	114 000	710 000	160 000	1 600	1 900
340-R	200	7.8740	420	16.5354	80	3.1496	4.0	.16	1.5	.060	56 400	87.5	553 000	124 000	780 000	175 000	1 500	1 800
342-R	210	8.2677	440	17.3228	84	3.3071	4.0	.16	1.5	.060	62 200	96.5	592 000	133 000	865 000	194 000	1 400	1 700
344-R	220	8.6614	460	18.1102	88	3.4646	4.0	.16	1.5	.060	68 400	106	637 000	143 000	950 000	214 000	1 300	1 600
348-R	240	9.4488	500	19.6850	95	3.7402	4.0	.16	1.5	.060	74 800	116	676 000	152 000	1 060 000	238 000	1 100	1 400
352-R	260	10.2362	540	21.2598	102	4.0157	5.0	.20	2.0	.080	87 100	135	741 000	167 000	1 250 000	281 000	1 100	1 300
356-R	280	11.0236	580	22.8346	108	4.2520	5.0	.20	2.0	.080	102 000	158	832 000	187 000	1 460 000	328 000	980	1 200

¹⁾ Fillet radius indicates maximum fillet radius on shaft or in housing which bearing corner will clear.

²⁾ Listed values are for pressed steel or polyamide cage, ABEC-1.

For phenolic composition cage, multiply by 1.66 for grease and 2.00 for oil. For machined bronze cage, multiply by 1.25 for grease and 1.50 for oil. For phenolic composition cage, ABEC-5 or 7, multiply by 2.30 for grease and 2.80 for oil. The speed rating adjustment factors have been determined through historical application and practice. For a more complete explanation, see page 276.

³⁾ Rating for one million revolutions or 500 hours at 33 1/3 RPM.

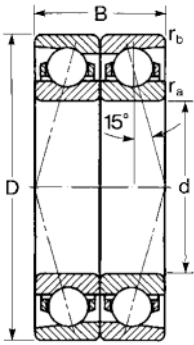

"D" indicates a duplex ground half pair matched with an identical half pair and is followed by an additional suffix letter to describe the type of duplex. See pages 236 and 237 for suffix description.

Note: ABEC 1 & 3 are stocked as half-pairs where available

Use these values for back-to-back (DB) or face-to-face (DF) mounting arrangements

MRC Bearing Number	Bore		Outside Diameter		Width		Fillet Radius ¹⁾					Basic Radial Load Rating				Speed Rating ²⁾		
	d	mm	D	mm	B	mm	r _a		r _b		ZD ²⁾		Dynamic C ₃₎		Static C ₀		Grease RPM	Oil RPM
							in	in	mm	in	mm	in	mm	in	N	lbf		
301-RD	12	.4724	37	1.4567	24	.9449	1.0	.04	.60	.024	439	.68	17 200	3 870	9 800	2 200	15 000	19 000
302-RD	15	.5906	42	1.6535	26	1.0236	1.0	.04	.60	.024	510	.79	19 900	4 470	12 900	2 900	14 000	16 000
303-RD	17	.6693	47	1.8504	28	1.1024	1.0	.04	.60	.024	632	.98	23 800	5 350	16 300	3 660	13 000	15 000
304-RD	20	.7874	52	2.0472	30	1.1811	1.0	.04	.60	.024	909	1.41	32 500	7 310	22 400	5 040	10 000	13 000
305-RD	25	.9843	62	2.4409	34	1.3386	1.0	.04	.60	.024	1 090	1.69	37 700	8 480	30 500	6 860	8 800	11 000
306-RD	30	1.1811	72	2.8346	38	1.4961	1.0	.04	.60	.024	1 480	2.30	50 700	11 400	40 000	8 990	7 200	8 800
307-RD	35	1.3780	80	3.1496	42	1.6535	1.5	.06	1.0	.040	1 940	3.00	63 700	14 300	52 000	11 700	6 800	8 000
308-RD	40	1.5748	90	3.5433	46	1.8110	1.5	.06	1.0	.040	2 450	3.80	79 300	17 800	67 000	15 100	6 000	7 200
309-RD	45	1.7717	100	3.9370	50	1.9685	1.5	.06	1.0	.040	3 030	4.69	95 600	21 500	81 500	18 300	5 400	6 400
310-RD	50	1.9685	110	4.3307	54	2.1260	2.0	.08	1.0	.040	4 350	6.75	133 000	29 900	114 000	25 600	5 000	6 000
311-RD	55	2.1654	120	4.7244	58	2.2835	2.0	.08	1.0	.040	5 110	7.92	153 000	34 400	134 000	30 100	4 500	5 400
312-RD	60	2.3622	130	5.1181	62	2.4409	2.0	.08	1.0	.040	5 930	9.19	174 000	39 100	156 000	35 100	4 000	4 800
313-RD	65	2.5591	140	5.5118	66	2.5984	2.0	.08	1.0	.040	6 900	10.7	195 000	43 800	190 000	42 700	3 800	4 500
314-RD	70	2.7559	150	5.9055	70	2.7559	2.0	.08	1.0	.040	6 770	10.5	199 000	44 700	190 000	42 700	3 600	4 200
315-RD	75	2.9528	160	6.2992	74	2.9134	2.0	.08	1.0	.040	9 030	14.0	247 000	55 500	245 000	55 100	3 400	4 000
316-RD	80	3.1496	170	6.6929	78	3.0709	2.0	.08	1.0	.040	9 480	14.7	255 000	57 300	260 000	58 500	3 000	3 600
317-RD	85	3.3465	180	7.0866	82	3.2283	2.5	.10	1.0	.040	11 400	17.7	291 000	65 400	310 000	67 400	2 900	3 400
318-RD	90	3.5433	190	7.4803	86	3.3858	2.5	.10	1.0	.040	11 800	18.3	302 000	67 900	325 000	73 100	2 700	3 200
319-RD	95	3.7402	200	7.8740	90	3.5433	2.5	.10	1.0	.040	13 100	20.3	325 000	73 100	360 000	80 900	2 600	3 000
320-RD	100	3.9370	215	8.4646	94	3.7008	2.5	.10	1.0	.040	14 400	22.4	345 000	77 600	400 000	89 900	2 400	2 900
321-RD	105	4.1339	225	8.8583	98	3.8583	2.5	.10	1.0	.040	15 900	24.6	371 000	83 400	415 000	93 300	2 200	2 700
322-RD	110	4.3307	240	9.4488	100	3.9370	2.5	.10	1.0	.040	18 800	29.2	416 000	93 500	510 000	115 000	2 100	2 600
324-RD	120	4.7244	260	10.2362	110	4.3307	2.5	.10	1.0	.040	22 100	34.3	436 000	98 000	600 000	135 000	2 000	2 400
326-RD	130	5.1181	280	11.0236	116	4.5669	3.0	.12	1.0	.040	25 700	39.8	475 000	107 000	695 000	156 000	1 800	2 200
328-RD	140	5.5118	300	11.8110	124	4.8819	3.0	.12	1.0	.040	29 500	45.7	572 000	129 000	800 000	180 000	1 700	2 100
330-RD	150	5.9055	320	12.5984	130	5.1181	3.0	.12	1.0	.040	33 900	52.6	624 000	140 000	950 000	214 000	1 600	1 900
332-RD	160	6.2992	340	13.3858	136	5.3543	3.0	.12	1.0	.040	38 400	59.6	689 000	155 000	1 080 000	243 000	1 400	1 800
334-RD	170	6.6929	360	14.1732	144	5.6693	3.0	.12	1.0	.040	40 800	63.2	715 000	161 000	1 140 000	256 000	1 400	1 700
336-RD	180	7.0866	380	14.9606	150	5.9055	3.0	.12	1.0	.040	45 700	70.9	780 000	175 000	1 270 000	286 000	1 300	1 600
338-RD	190	7.4803	400	15.7480	156	6.1417	4.0	.16	1.5	.060	51 000	79.0	832 000	187 000	1 430 000	321 000	1 300	1 500
340-RD	200	7.8740	420	16.5354	160	6.2992	4.0	.16	1.5	.060	56 400	87.5	904 000	203 000	1 560 000	351 000	1 200	1 400
342-RD	210	8.2677	440	17.3228	168	6.6142	4.0	.16	1.5	.060	62 200	96.5	956 000	215 000	1 730 000	389 000	1 100	1 400
344-RD	220	8.6614	460	18.1102	176	6.9291	4.0	.16	1.5	.060	68 400	106.0	1 040 000	234 000	1 900 000	427 000	1 000	1 300
348-RD	240	9.4488	500	19.6850	190	7.4803	4.0	.16	1.5	.060	74 800	116.0	1 080 000	243 000	2 120 000	477 000	880	1 100
352-RD	260	10.2362	540	21.2598	204	8.0315	5.0	.20	2.0	.080	87 100	135.0	1 210 000	272 000	2 500 000	562 000	880	1 000
356-RD	280	11.0236	580	22.8346	216	8.5039	5.0	.20	2.0	.080	102 000	158.0	1 350 000	303 000	2 900 000	652 000	780	960

¹⁾ Fillet radius indicates maximum fillet radius on shaft or in housing which bearing corner will clear.

²⁾ Listed values are for pressed steel or polyamide cage, ABEC-1.

For phenolic composition cage, multiply by 1.66 for grease and 2.00 for oil. For machined bronze cage, multiply by 1.25 for grease and 1.50 for oil. For phenolic composition cage, ABEC-5 or 7, multiply by 2.30 for grease and 2.80 for oil. The speed rating adjustment factors have been determined through historical application and practice. For a more complete explanation, see page 276.

³⁾ Rating for one million revolutions or 500 hours at 33 1/3 RPM.

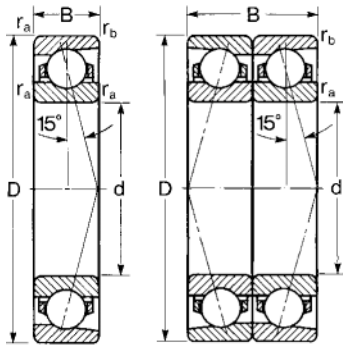

Note: ABEC 1 & 3 are stocked as half-pairs where available

400-R and -RD Heavy Series bearings are available in bores from 17 mm to 110 mm. They can handle very heavy radial loads, one-directional thrust loads, or a combination of both. Use duplex bearings for two-directional thrust loads.

"D" indicates a duplex ground half pair matched with an identical half pair and is followed by an additional suffix letter to describe the type of duplex. See pages 236 and 237 for suffix description.

Values for -RD bearings are for back-to-back (DB) or face-to-face (DF) mounting arrangements.

MRC Bearing Number	Bore d mm in		Outside Diameter D mm in		Width B mm in		Fillet Radius ¹⁾ r _a r _b mm in mm in				Basic Radial Load Rating				Speed Rating ²⁾			
											Dynamic C ₃₎		Static C ₀		Grease RPM	Oil RPM		
											N	lbf	N	lbf				
403-R	17	.6693	62	2.4409	17	.6693	1.0	.04	.60	.024	1 290	2.00	23 400	5 260	14 600	3 280	12 000	15 000
404-R	20	.7874	72	2.8346	19	.7480	1.0	.04	.60	.024	1 840	2.85	37 100	8 340	21 200	4 770	10 000	13 000
405-R	25	.9843	80	3.1496	21	.8268	1.5	.06	1.0	.040	2 270	3.52	44 900	10 100	26 500	5 960	9 000	11 000
406-R	30	1.1811	90	3.5433	23	.9055	1.5	.06	1.0	.040	3 050	4.73	49 400	11 100	36 000	8 090	8 500	10 000
407-R	35	1.3780	100	3.9370	25	.9843	1.5	.06	1.0	.040	3 620	5.62	58 500	13 200	44 000	9 890	7 000	8 500
408-R	40	1.5748	110	4.3307	27	1.0630	2.0	.08	1.0	.040	4 260	6.60	67 600	15 200	52 000	11 700	6 700	8 000
409-R	45	1.7717	120	4.7244	29	1.1417	2.0	.08	1.0	.040	4 940	7.66	78 000	17 500	61 000	13 700	6 000	7 000
410-R	50	1.9685	130	5.1181	31	1.2205	2.0	.08	1.0	.040	6 240	9.67	95 600	21 500	78 000	17 500	5 300	6 300
411-R	55	2.1654	140	5.5118	33	1.2992	2.0	.08	1.0	.040	7 100	11.0	108 000	24 300	90 000	20 200	5 000	6 000
412-R	60	2.3622	150	5.9055	35	1.3780	2.0	.08	1.0	.040	8 000	12.4	117 000	26 300	102 000	22 900	4 800	5 600
413-R	65	2.5591	160	6.2992	37	1.4567	2.0	.08	1.0	.040	8 970	13.9	127 000	28 600	112 000	25 200	4 500	5 300
414-R	70	2.7559	180	7.0866	42	1.6535	2.5	.10	1.0	.040	12 200	18.9	156 000	35 100	150 000	33 700	3 800	4 500
415-R	75	2.9528	190	7.4803	45	1.7717	2.5	.10	1.0	.040	13 400	20.8	168 000	37 800	166 000	37 300	3 600	4 300
416-R	80	3.1496	200	7.8740	48	1.8898	2.5	.10	1.0	.040	14 600	22.7	178 000	40 000	183 000	41 100	3 400	4 000
417-R	85	3.3465	210	8.2677	52	2.0472	3.0	.12	1.0	.040	16 000	24.8	190 000	42 700	200 000	45 000	3 200	3 800
418-R	90	3.5433	225	8.8583	54	2.1260	3.0	.12	1.0	.040	18 700	29.0	212 000	47 700	236 000	53 100	3 000	3 600
419-R	95	3.7402	250	9.8425	55	2.1654	3.0	.12	1.0	.040	21 700	33.7	234 000	52 600	275 000	60 700	2 700	3 300
420-R	100	3.9370	265	10.4331	60	2.3622	3.0	.12	1.0	.040	25 000	38.7	260 000	58 500	305 000	68 600	2 500	3 100
421-R	105	4.1339	290	11.4173	65	2.5591	3.0	.12	1.0	.040	29 200	45.2	286 000	64 300	355 000	79 800	2 400	2 900
422-R	110	4.3307	320	12.5984	70	2.7559	3.0	.12	1.0	.040	34 500	53.5	319 000	71 700	425 000	95 500	2 100	2 600
400-RD																		
403-RD	17	.6693	62	2.4409	34	1.3386	1.0	.04	.60	.024	1 290	2.00	37 700	8 480	29 000	6 520	9 600	12 000
404-RD	20	.7874	72	2.8346	38	1.4961	1.0	.04	.60	.024	1 840	2.85	60 500	13 600	42 500	9 550	8 000	10 000
405-RD	25	.9843	80	3.1496	42	1.6535	1.5	.06	1.0	.040	2 270	3.52	74 100	16 700	53 000	11 900	7 200	8 800
406-RD	30	1.1811	90	3.5433	46	1.8110	1.5	.06	1.0	.040	3 050	4.73	80 600	18 100	72 000	16 200	6 800	8 000
407-RD	35	1.3780	100	3.9370	50	1.9685	1.5	.06	1.0	.040	3 620	5.62	95 600	21 500	86 500	19 400	5 600	6 800
408-RD	40	1.5748	110	4.3307	54	2.1260	2.0	.08	1.0	.040	4 260	6.60	111 000	25 000	104 000	23 400	5 400	6 400
409-RD	45	1.7717	120	4.7244	58	2.2835	2.0	.08	1.0	.040	4 940	7.66	127 000	28 600	122 000	27 400	4 800	5 600
410-RD	50	1.9685	130	5.1181	62	2.4409	2.0	.08	1.0	.040	6 240	9.67	153 000	34 400	156 000	35 100	4 200	5 000
411-RD	55	2.1654	140	5.5118	66	2.5984	2.0	.08	1.0	.040	7 100	11.0	174 000	39 100	180 000	40 500	4 000	4 800
412-RD	60	2.3622	150	5.9055	70	2.7559	2.0	.08	1.0	.040	8 000	12.4	190 000	42 700	204 000	45 900	3 800	4 500
413-RD	65	2.5591	160	6.2992	74	2.9134	2.0	.08	1.0	.040	8 970	13.9	208 000	46 800	224 000	50 400	3 600	4 200
414-RD	70	2.7559	180	7.0866	84	3.3071	2.5	.10	1.0	.040	12 200	18.9	255 000	57 300	300 000	67 400	3 000	3 600
415-RD	75	2.9528	190	7.4803	90	3.5433	2.5	.10	1.0	.040	13 400	20.8	270 000	60 700	335 000	75 300	2 900	3 400
416-RD	80	3.1496	200	7.8740	96	3.7795	2.5	.10	1.0	.040	14 600	22.7	286 000	64 300	365 000	82 100	2 700	3 200
417-RD	85	3.3465	210	8.2677	104	4.0945	3.0	.12	1.0	.040	16 000	24.8	307 000	69 000	400 000	89 900	2 600	3 000
418-RD	90	3.5433	225	8.8583	108	4.2520	3.0	.12	1.0	.040	18 700	29.0	345 000	77 600	465 000	105 000	2 400	2 900
419-RD	95	3.7402	250	9.8425	110	4.3307	3.0	.12	1.0	.040	21 700	33.7	377 000	84 800	550 000	124 000	2 200	2 600
420-RD	100	3.9370	265	10.4331	120	4.7244	3.0	.12	1.0	.040	25 000	38.7	416 000	93 500	610 000	137 000	2 000	2 500
421-RD	105	4.1339	290	11.4173	130	5.1181	3.0	.12	1.0	.040	29 200	45.2	462 000	104 000	710 000	160 000	1 900	2 300
422-RD	110	4.3307	320	12.5984	140	5.5118	3.0	.12	1.0	.040	34 500	53.5	520 000	117 000	850 000	191 000	1 700	2 100

¹⁾ Fillet radius indicates maximum fillet radius on shaft or in housing which bearing corner will clear.

²⁾ Listed values are for pressed steel or polyamide cage, ABEC-1.

For phenolic composition cage, multiply by 1.66 for grease and 2.00 for oil. For machined bronze cage, multiply by 1.25 for grease and 1.50 for oil. For phenolic composition cage, ABEC-5 or 7, multiply by 2.30 for grease and 2.80 for oil. The speed rating adjustment factors have been determined through historical application and practice. For a more complete explanation, see page 276.

³⁾ Rating for one million revolutions or 500 hours at 33 1/3 RPM.

XLS Type Single-Row Inch Size 15 Degree Angular Contact

MRC Bearing Services

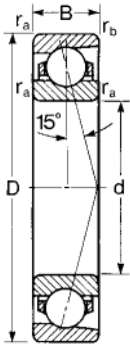

MRC XLS Series bearings are single-row 15 degree angular contact bearings made to inch dimensions. They are similar to MRC R-type bearings and 7000 Series bearings. The XLS Series bearing is made with a heavy race shoulder and one counterbored race shoulder on the outer ring. MRC XLS Series bearings have ample radial and thrust capacity for the majority of applications involving light radial loads, light thrust loads in one direction, or combinations of these. They are used in such applications where space limitations exist.

MRC Bearing Number	Bore		Outside Diameter D		Width B		Fillet Radius ¹⁾				Basic Radial Load Rating				Speed Rating ²⁾			
											Dynamic C ³⁾		Static C ₀		Grease	Oil		
	d	mm	in	mm	in	mm	in	mm	in	mm	in	mm	in	N	lbf	N	lbf	RPM
XLS-1 ³ / ₈	34.9	1.3750	65.1	2.5625	14.3	.5625	1.0	.04	.60	.024	1 060	1.65	22 500	5 060	15 600	3 510	11 000	13 000
XLS-1 ¹ / ₂	38.1	1.5000	68.3	2.6875	14.3	.5625	1.0	.04	.60	.024	1 140	1.77	23 800	5 350	17 000	3 820	9 800	12 000
XLS-1 ¹ / ₄	41.3	1.6250	73.0	2.8750	14.3	.5625	1.0	.04	.60	.024	1 220	1.89	24 200	5 400	18 600	4 180	9 000	11 000
XLS-1 ³ / ₄	44.5	1.7500	76.2	3.0000	14.3	.5625	1.0	.04	.60	.024	1 300	2.01	25 100	5 640	20 000	4 500	8 200	10 000
XLS-1 ⁷ / ₈	47.6	1.8750	80.1	3.1875	15.9	.625	1.0	.04	.60	.024	1 540	2.39	29 600	6 650	23 600	5 310	8 200	10 000
XLS-2	50.8	2.0000	84.1	3.3125	15.9	.625	1.0	.04	.60	.024	1 630	2.53	32 000	6 790	25 500	5 730	7 800	9 500
XLS-2 ¹ / ₈	54.0	2.1250	87.3	3.4375	15.9	.625	1.5	.06	.60	.024	1 630	2.53	30 200	6 790	25 500	5 730	7 400	9 000
XLS-2 ¹ / ₄	57.2	2.2500	90.5	3.5625	15.9	.625	1.5	.06	.60	.024	1 720	2.67	31 200	7 010	27 000	6 070	7 100	8 700
XLS-2 ¹ / ₂ -S	63.5	2.5000	98.4	3.8750	17.5	.6875	1.5	.06	.60	.024	1 360	2.11	26 000	5 850	22 000	4 950	6 500	7 900
XLS-2 ³ / ₄	63.5	2.5000	98.4	3.8750	17.5	.6875	1.5	.06	.60	.024	1 900	2.95	32 500	7 310	31 000	6 740	6 400	7 800
XLS-2 ⁵ / ₈	66.7	2.6250	105	4.1250	17.5	.6875	1.5	.06	.60	.024	2 470	3.83	42 300	9 510	39 000	8 770	6 100	7 400
XLS-2 ³ / ₄	70.0	2.7500	105	4.1250	17.5	.6875	1.5	.06	.60	.024	2 470	3.83	42 300	9 510	39 000	8 770	6 000	7 300
XLS-3	76.2	3.0000	114	4.5000	19.1	.750	2.0	.08	1.0	.040	2 720	4.21	44 200	9 940	44 000	9 890	5 500	6 700
XLS-3 ¹ / ₄	82.6	3.2500	121	4.7500	19.1	.750	2.0	.08	1.0	.040	2 840	4.40	44 900	10 100	46 500	10 500	5 100	6 200
XLS-3 ¹ / ₂	88.9	3.5000	127	5.0000	19.1	.750	2.0	.08	1.0	.040	3 090	4.79	47 500	10 700	51 000	11 500	4 800	5 900
XLS-3 ³ / ₄	95.3	3.7500	133	5.2500	19.1	.750	2.0	.08	1.0	.040	3 210	4.98	47 500	10 700	53 000	11 900	4 500	5 500
XLS-4 ¹ / ₄	108	4.2500	152	6.0000	22.2	.875	2.0	.08	1.0	.040	4 190	6.50	61 800	13 900	69 500	15 600	3 900	4 800
XLS-4 ¹ / ₂	114	4.5000	159	6.2500	22.2	.875	2.0	.08	1.0	.040	4 350	6.75	61 800	13 900	73 500	16 500	3 800	4 600
XLS-4 ³ / ₄	121	4.7500	165	6.5000	22.2	.875	2.0	.08	1.0	.040	4 520	7.00	63 700	14 300	76 500	17 200	3 600	4 400
XLS-5	127	5.0000	178	7.0000	25.4	1.000	2.0	.08	1.0	.040	5 510	8.54	78 000	17 500	91 500	20 600	3 400	4 100
XLS-5 ¹ / ₂	140	5.5000	191	7.5000	25.4	1.000	2.5	.10	1.0	.040	5 920	9.18	79 300	17 800	100 000	22 500	3 100	3 800
XLS-6	152	6.0000	203	8.0000	25.4	1.000	2.5	.10	1.0	.040	6 330	9.81	81 900	18 400	108 000	24 300	2 900	3 500
XLS-6 ¹ / ₄	159	6.2500	216	8.5000	28.6	1.125	2.5	.10	1.0	.040	7 550	11.7	97 500	21 900	129 000	29 000	2 700	3 300
XLS-6 ¹ / ₂	165	6.5000	222	8.7500	28.6	1.125	2.5	.10	1.0	.040	7 800	12.0	99 500	22 400	134 000	30 100	2 600	3 200
XLS-7	178	7.0000	241	9.5000	31.8	1.250	3.0	.12	1.5	.060	9 480	14.7	119 000	26 800	160 000	36 000	2 400	2 900
XLS-7 ¹ / ₄	184	7.2500	248	9.7500	31.8	1.250	3.0	.12	1.5	.060	9 740	15.1	121 000	27 200	166 000	37 300	2 300	2 800
XLS-7 ³ / ₄	197	7.7500	267	10.5000	34.9	1.375	3.0	.12	1.5	.060	11 200	17.4	138 000	31 000	193 000	43 400	2 100	2 600
XLS-8	203	8.0000	273	10.7500	34.9	1.375	3.0	.12	1.5	.060	11 600	18.0	140 000	31 500	200 000	45 000	2 100	2 500
XLS-8 ¹ / ₄	210	8.2500	279	11.0000	34.9	1.375	3.0	.12	1.5	.060	12 000	18.6	140 000	31 500	204 000	45 900	2 100	2 500
XLS-8 ¹ / ₂	216	8.5000	292	11.5000	38.1	1.500	3.0	.12	1.5	.060	13 600	21.0	163 000	36 600	232 000	52 200	2 000	2 400
XLS-9	229	9.0000	305	12.0000	38.1	1.500	3.0	.12	1.5	.060	15 300	23.7	182 000	40 900	260 000	58 500	1 900	2 300
XLS-10	254	10.0000	337	13.2500	41.3	1.625	4.0	.16	1.5	.060	17 300	26.8	190 000	42 700	290 000	65 200	1 600	2 000

¹⁾ Fillet radius indicates maximum fillet radius on shaft or in housing which bearing corner will clear.

²⁾ Listed values are for pressed steel or polyamide cage, ABEC-1.

For phenolic composition cage, multiply by 1.66 for grease and 2.00 for oil. For machined bronze cage, multiply by 1.25 for grease and 1.50 for oil. For phenolic composition cage, ABEC-5 or 7, multiply by 2.30 for grease and 2.80 for oil. The speed rating adjustment factors have been determined through historical application and practice. For a more complete explanation, see page 276.

³⁾ Rating for one million revolutions or 500 hours at 33¹/₃ RPM.

NOTES

**Dynamic and static equivalent radial load
and life rating**

Dynamic equivalent radial load

$P = XF_R + YF_A$ P = Dynamic equivalent radial load
 F_R = Radial load
 F_A = Thrust load
 Z = Number of balls
 D = Ball diameter
 X = Radial load factor
 Y = Thrust load factor
 e = Limiting factor for F_A/F_R

Static equivalent radial load

$P_0 = 0.6 F_R + 0.5 F_A$
 P_0 is always $\geq F_R$
 P_0 = Static equivalent radial load
 F_R = Radial load
 F_A = Thrust load

Contact Angle	F_A/ZD^2		$F_A/F_R > e$		e
	Units N, mm	Units lb, in	X	Y	
15°	0.172	25	0.44	1.47	0.38
	0.345	50		1.40	0.40
	0.689	100		1.30	0.43
	1.03	150		1.23	0.46
	1.38	200		1.19	0.47
	2.07	300		1.12	0.50
	3.45	500		1.02	0.55
	5.17	750		1.00	0.56
	6.89	1 000		1.00	0.56

When $F_A/F_R \leq e$, use $X = 1.0$, $Y = 0$.
 Values of Y for loads not shown are obtained from chart to the right.

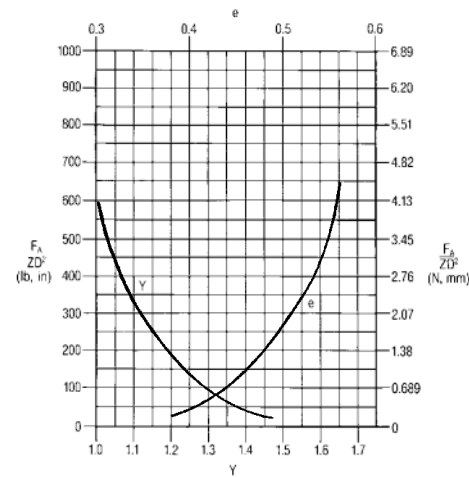

Life rating

$L_{10} = \left(\frac{C}{P}\right)^3$ (Millions of revolutions)

or

$L_{10h} = \frac{10^6}{60n} \left(\frac{C}{P}\right)^3$ (Hours)

- C = Basic dynamic load rating
- P = Dynamic equivalent radial load
- n = Speed in RPM

**Dynamic equivalent radial load
and life calculation examples**

Bearing size: 309R
Speed = 2000 RPM
Basic dynamic load rating (C) = 13200 lbf
ZD² = 4.69

Case 1

Radial load (F_R) = 1890

Equivalent load (P) = X F_R + Y F_A

P = F_R = 1890

$$\text{Life (L}_{10}\text{)} = \left(\frac{C}{P}\right)^3 = \left(\frac{13200}{1890}\right)^3 = 341 \times 10^6 \text{ Rev.}$$

or

$$\begin{aligned}\text{Life (L}_{10}\text{h)} &= \frac{10^6}{60n} \left(\frac{C}{P}\right)^3 = \frac{10^6}{60 \times 2000} \left(\frac{13200}{1890}\right)^3 \\ &= 2839 \text{ Hrs}\end{aligned}$$

Case 2

Radial load (F_R) = 1890

Thrust load (F_A) = 1250

Equivalent load (P) = X F_R + Y F_A

F_A/ZD² = 1250/4.69 = 267

X = 0.44

Y = 1.15

P = 0.44 × 1890 + 1.15 × 1250 = 2269

$$\text{Life (L}_{10}\text{)} = \left(\frac{C}{P}\right)^3 = \left(\frac{13200}{2269}\right)^3 = 197 \times 10^6 \text{ Rev.}$$

or

$$\begin{aligned}\text{Life (L}_{10}\text{h)} &= \frac{10^6}{60n} \left(\frac{C}{P}\right)^3 = \frac{10^6}{60 \times 2000} \left(\frac{13200}{2269}\right)^3 \\ &= 1641 \text{ Hrs}\end{aligned}$$

Case 3

Thrust load (F_A) = 1250

Equivalent load (P) = Y F_A

F_A/ZD² = 1250/4.69 = 267

Y = 1.15

P = 1.15 × 1250 = 1438

$$\text{Life (L}_{10}\text{)} = \left(\frac{C}{P}\right)^3 = \left(\frac{13200}{1438}\right)^3 = 773 \times 10^6 \text{ Rev.}$$

or

$$\begin{aligned}\text{Life (L}_{10}\text{h)} &= \frac{10^6}{60n} \left(\frac{C}{P}\right)^3 = \frac{10^6}{60 \times 2000} \left(\frac{13200}{1438}\right)^3 \\ &= 6646 \text{ Hrs}\end{aligned}$$

Dynamic equivalent radial load

$P = X F_R + Y F_A$ P = Dynamic equivalent radial load
 F_R = Radial load
 F_A = Thrust load
 X = Radial load factor
 Y = Thrust load factor
 Z = Number of balls
 D = Ball diameter
 e = Limiting factor for F_A/F_R

Contact Angle	F_A / ZD^2		Tandem DT Mounting		DB or DF Mounting				e	
	Units N, mm	Units lb, in	$F_A/F_R > e$		$F_A/F_R \leq e$		$F_A/F_R > e$			
			X	Y	X	Y	X	Y		
15°	0.172	25	0.44	1.47	1	1.65	0.72	2.39	0.38	
	0.345	50		1.40		1.57		2.28		0.40
	0.689	100		1.30		1.46		2.11		0.43
	1.03	150		1.23		1.38		2.00		0.46
	1.38	200		1.19		1.34		1.93		0.47
	2.07	300		1.12		1.26		1.82		0.50
	3.45	500		1.02		1.14		1.66		0.55
	5.17	750		1.00		1.12		1.63		0.56
	6.89	1 000		1.00		1.12		1.63		0.56

For tandem DT, when $F_A/F_R < e$, use $X = 1.0$, $Y = 0$
 Values of Y for loads not shown are obtained from chart below

Life rating

$L_{10} = \left(\frac{C}{P}\right)^3$ (millions of revolutions)

or

$L_{10h} = \frac{10^6}{60n} \left(\frac{C}{P}\right)^3$ (Hours)

For DB or DF Mounting:

C = Duplex pair dynamic radial load rating (from duplex bearing tables)
 or

C = Single-row dynamic radial load rating times $(i)^{0.7}$, where $i = 2$

For tandem mounting:

C = Single-row dynamic radial load rating times $(i)^{0.7}$, where i = number of bearings in set

P = Dynamic equivalent radial load

n = Speed in RPM

Static equivalent radial load

$P_0 = 1.0 F_R + 0.94 F_A$
 P_0 = Static equivalent radial load
 F_R = Radial load
 F_A = Thrust load

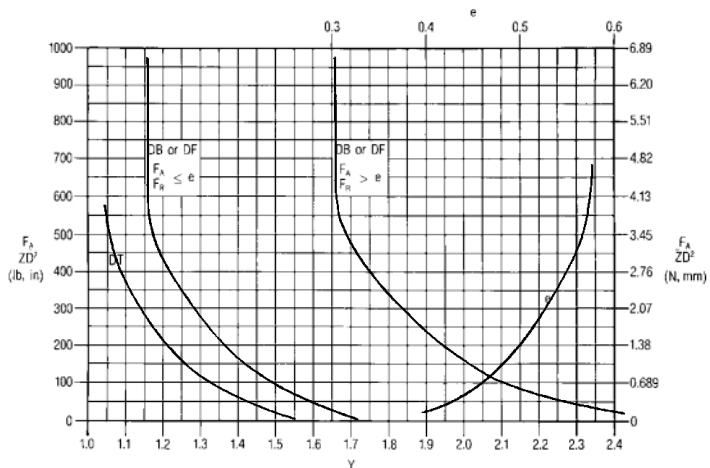

Dynamic equivalent radial load and life calculation examples

Bearing size: 309 RDU (DB or DF Pair)
Speed: 2000 RPM
Duplex pair basic dynamic radial load
Rating (C) = 21500 lbf
ZD² = 4.69

Case 1

Radial load (F_R) = 1890
Thrust load (F_A) = 1250
Equivalent load (P) = X F_R + Y F_A
F_A/F_R = 1250/1890 = 0.66
F_A/ZD² = 1250/4.69 = 267
Since F_A/F_R > e, X = 0.72, Y = 1.86
P = 0.72 × 1890 + 1.86 × 1250 = 3686
Life (L10) = $\left(\frac{C}{P}\right)^3 = \left(\frac{21500}{3686}\right)^3 = 198 \times 10^6$ Rev.
or
Life (L10h) = $\frac{10^6}{60n} \left(\frac{C}{P}\right)^3 = \frac{10^6}{60 \times 2000} \left(\frac{21500}{3686}\right)^3$
= 1654 Hrs

Case 2

Radial load (F_R) = 1890
Thrust load (F_A) = 450
Equivalent load (P) = X F_R + Y F_A
F_A/F_R = 450/1890 = 0.24
F_A/ZD² = 450/4.69 = 96
Since F_A/F_R < e, X = 1.0, Y = 1.46
P = 1.0 × 1890 + 1.46 × 450 = 2547
Life (L10) = $\left(\frac{C}{P}\right)^3 = \left(\frac{21500}{2547}\right)^3 = 601 \times 10^6$ Rev.
or
Life (L10h) = $\frac{10^6}{60n} \left(\frac{C}{P}\right)^3 = \frac{10^6}{60 \times 2000} \left(\frac{21500}{2547}\right)^3$
= 5012 Hrs

Case 3

Thrust load (F_A) = 1250
Equivalent load (P) = X F_R + Y F_A
F_A/F_R = 1250/0 = ∞
F_A/ZD² = 1250/4.69 = 267
Since F_A/F_R > e, Y = 1.86
P = 1.86 × 1250 = 2325
Life (L10) = $\left(\frac{C}{P}\right)^3 = \left(\frac{21500}{2325}\right)^3 = 791 \times 10^6$ Rev.
or
Life (L10h) = $\frac{10^6}{60n} \left(\frac{C}{P}\right)^3 = \frac{10^6}{60 \times 2000} \left(\frac{21500}{2325}\right)^3$
= 6590 Hrs

Bearing size: 309 RDT
3 bearings in tandem
Speed: 2000 RPM
Single-row basic dynamic radial
Load Rating (C) = 13200 lbf
ZD² = 4.69

Case 1

Thrust load (F_A) = 2500
Equivalent load (P) = X F_R + Y F_A
F_A/F_R = 2500/0 = ∞
F_A/ZD² = 2500/4.69 = 533
Since F_A/F_R > e, X = 0.44, Y = 1.02
P = 1.02 × 2500 = 2550
Load rating = (i)^{0.7} × 13200
= (3)^{0.7} × 13200 = 28510
Life (L10) = $\left(\frac{C}{P}\right)^3 = \left(\frac{28510}{2550}\right)^3 = 1398 \times 10^6$ Rev.
or
Life (L10h) = $\frac{10^6}{60n} \left(\frac{C}{P}\right)^3 = \frac{10^6}{60 \times 2000} \left(\frac{28510}{2550}\right)^3$
= 11650 Hrs

Case 2

Radial load (F_R) = 1890
Thrust load (F_A) = 2500
Equivalent load (P) = X F_R + Y F_A
F_A/F_R = 2500/1890 = 1.32
F_A/ZD² = 2500/4.69 = 533
Since F_A/F_R > e, X = 0.44, Y = 1.02
P = 0.44 × 1890 + 1.02 × 2500 = 3382
Load rating = (i)^{0.7} × 13200
= (3)^{0.7} × 13200 = 28510
Life (L10) = $\left(\frac{C}{P}\right)^3 = \left(\frac{28510}{3382}\right)^3 = 599 \times 10^6$ Rev.
or
Life (L10h) = $\frac{10^6}{60n} \left(\frac{C}{P}\right)^3 = \frac{10^6}{60 \times 2000} \left(\frac{28510}{3382}\right)^3$
= 4992 Hrs

NOTES

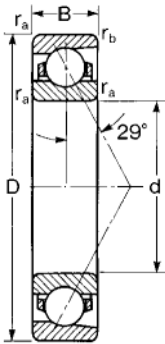

7000 Series bearings are single-row 29-degree angular contact bearings having one heavy race shoulder and one counterbored race shoulder on the outer ring. Because of this construction, it is possible to incorporate a greater number of balls than in the deep-groove nonfilling-notch bearing. The combination of maximum ball complement and the angular contact feature reduces the specific ball loading under thrust load, resulting in high thrust load carrying capacity.

MRC 7000 Series angular contact bearings should be used in applications in which the thrust load is especially heavy and beyond the capacity of single-row types; for example, for a very heavy thrust load in one direction, or a heavy thrust load in one direction combined with a radial load.

Cage Types and Materials

For normal usage: heavy stock, two-piece steel formed pockets, with turned-over fingers or riveted together. For severe vibration, very high speeds, or high operating temperatures: one-piece machined construction of suitable material (phenolic composition, bronze, or special material riding ground O.D. of inner ring).

Size	Series	Page
7100/D	Extra Large—Single and Duplex Set	84
7100KR	Extra Light—Single Bearing	85
7100KRD	Extra Light—Duplex Set	86
7200	Light—Single Bearing	87
7200D	Light—Duplex Set	88
7300	Medium—Single Bearing	89
7300D	Medium—Duplex Set	90
7400/D	Heavy—Single and Duplex Set	91
7000	Equivalent Load and Life	92
7000	Life Calculation Examples	93
7000D	Equivalent Load and Life	94
7000D	Life Calculation Examples	95

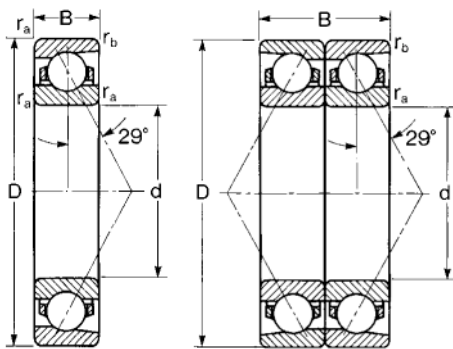

7100 Series bearings are similar to the 7100-KR Series but have a larger O.D. and narrower width, and are used for one-directional thrust loads or combined radial and thrust loads where the thrust load is predominant.

"D" indicates a duplex ground half pair matched with an identical half pair and is followed by an additional suffix letter to describe the type of duplex. See pages 236 and 237 for suffix description.

Caution: Single bearings are not to be used where only radial loads are present. For two-direction thrust loads, use duplex bearings.

Note: ABEC-1 & 3 stocked as half-pairs, where available.

Values for -D bearings are for back-to-back (DB) or face-to-face (DF) mounting arrangements.

MRC Bearing Number	Bore		Outside Diameter D		Width B		Fillet Radius ¹⁾				Basic Radial Load Rating ²⁾				Speed Rating ³⁾	
											Dynamic C _d ⁴⁾		Static C ₀		Grease RPM	Oil RPM
											N	lbf	N	lbf		
7120	100	3.9370	160	6.2992	28	1.1024	2.0	.08	1.0	.040	85 200	19 200	86 500	19 400	2 600	4 300
7122	110	4.3307	175	6.8898	30	1.1811	2.0	.08	1.0	.040	104 000	23 400	108 000	24 300	2 400	4 000
7124	120	4.7244	190	7.4803	32	1.2598	2.0	.08	1.0	.040	108 000	24 300	127 000	28 600	2 200	3 700
7126	130	5.1181	205	8.0709	34	1.3386	2.0	.08	1.0	.040	121 000	27 200	134 000	30 100	2 100	3 500
7128	140	5.5118	220	8.6614	36	1.4173	2.0	.08	1.0	.040	138 000	31 000	156 000	35 100	1 900	3 200
7130	150	5.9055	235	9.2520	38	1.4961	2.0	.08	1.0	.040	159 000	35 700	180 000	40 500	1 700	2 800
7132	160	6.2992	250	9.8425	40	1.5748	2.0	.08	1.0	.040	174 000	39 100	204 000	45 900	1 600	2 700
7134	170	6.6929	265	10.4331	42	1.6535	2.5	.10	1.0	.040	190 000	42 700	232 000	52 200	1 600	2 700
7136	180	7.0866	280	11.0236	44	1.7323	2.5	.10	1.0	.040	208 000	46 800	260 000	58 500	1 600	2 600
7138	190	7.4803	300	11.8110	46	1.8110	2.5	.10	1.0	.040	242 000	54 400	315 000	70 800	1 400	2 400
7140	200	7.8740	320	12.5984	48	1.8898	2.5	.10	1.0	.040	260 000	58 500	355 000	79 800	1 400	2 300
7142	210	8.2677	340	13.3858	50	1.9685	2.5	.10	1.0	.040	286 000	64 300	400 000	89 900	1 400	2 300
7144	220	8.6614	350	13.7795	51	2.0079	2.5	.10	1.0	.040	291 000	65 400	415 000	93 300	1 300	2 200
7146	230	9.0551	370	14.5669	53	2.0866	3.0	.12	1.0	.040	312 000	70 100	455 000	102 000	1 200	2 000
7148	240	9.4488	390	15.3543	55	2.1654	3.0	.12	1.0	.040	332 000	74 600	500 000	112 000	1 100	1 900
7152	260	10.2362	430	16.9291	59	2.3228	3.0	.12	1.0	.040	364 000	81 800	585 000	132 000	1 100	1 800
7156	280	11.0236	460	18.1102	63	2.4803	3.0	.12	1.0	.040	403 000	90 600	600 000	135 000	1 100	1 800
7164	320	12.5984	500	19.6850	71	2.7953	3.0	.12	1.0	.040	462 000	104 000	815 000	183 000	960	1 600

7100-D

7120-D	100	3.9370	160	6.2992	56	2.2047	2.0	.08	1.0	.040	140 000	31 500	173 000	38 900	2 100	3 400
7122-D	110	4.3307	175	6.8898	60	2.3622	2.0	.08	1.0	.040	168 000	37 800	216 000	48 600	1 900	3 200
7124-D	120	4.7244	190	7.4803	64	2.5197	2.0	.08	1.0	.040	178 000	40 000	255 000	57 300	1 800	3 000
7126-D	130	5.1181	205	8.0709	68	2.6772	2.0	.08	1.0	.040	195 000	43 800	270 000	60 700	1 700	2 800
7128-D	140	5.5118	220	8.6614	72	2.8346	2.0	.08	1.0	.040	225 000	50 600	310 000	69 700	1 500	2 600
7130-D	150	5.9055	235	9.2520	76	2.9921	2.0	.08	1.0	.040	255 000	57 300	360 000	80 900	1 400	2 200
7132-D	160	6.2992	250	9.8425	80	3.1496	2.0	.08	1.0	.040	286 000	64 300	405 000	91 000	1 300	2 200
7134-D	170	6.6929	265	10.4331	84	3.3071	2.5	.10	1.0	.040	312 000	70 100	465 000	105 000	1 300	2 200
7136-D	180	7.0866	280	11.0236	88	3.4646	2.5	.10	1.0	.040	338 000	76 000	520 000	117 000	1 300	2 100
7138-D	190	7.4803	300	11.8110	92	3.6220	2.5	.10	1.0	.040	390 000	87 700	630 000	142 000	1 100	1 900
7140-D	200	7.8740	320	12.5984	96	3.7795	2.5	.10	1.0	.040	423 000	95 100	695 000	156 000	1 100	1 800
7142-D	210	8.2677	340	13.3858	100	3.9370	2.5	.10	1.0	.040	468 000	105 000	800 000	180 000	1 100	1 800
7144-D	220	8.6614	350	13.7795	102	4.0157	2.5	.10	1.0	.040	475 000	107 000	830 000	187 000	1 000	1 800
7146-D	230	9.0551	370	14.5669	106	4.1732	3.0	.12	1.0	.040	507 000	114 000	915 000	206 000	960	1 600
7148-D	240	9.4488	390	15.3543	110	4.3307	3.0	.12	1.0	.040	540 000	121 000	1 000 000	225 000	880	1 500
7152-D	260	10.2362	430	16.9291	118	4.6457	3.0	.12	1.0	.040	592 000	133 000	1 160 000	261 000	880	1 400
7156-D	280	11.0236	460	18.1102	126	4.9606	3.0	.12	1.0	.040	663 000	149 000	1 200 000	270 000	880	1 400
7164-D	320	12.5984	500	19.6850	142	5.5904	3.0	.12	1.0	.040	761 000	171 000	1 630 000	366 000	770	1 300

¹⁾ Fillet radius indicates maximum fillet radius on shaft or in housing which bearing corner will clear.

²⁾ For thrust rating multiply C by 1.32 and C₀ by 2.94.

³⁾ Listed values are for machined bronze cage, ABEC-1.

For phenolic composition cage, multiply by 1.33 for both grease and oil. For phenolic composition cage, ABEC-5 or 7, multiply by 1.86 for both grease and oil. For pressed steel cage, ABEC-1, multiply by 0.67 for grease and 0.80 for oil. The speed rating adjustment factors have been determined through historical application and practice. For a more complete explanation, see page 276

⁴⁾ Rating for one million revolutions or 500 hours at 33 1/3 RPM.

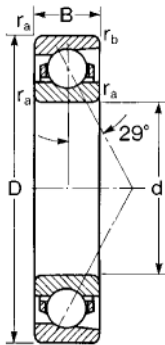

This series is available in bore sizes ranging from 10 mm to 320 mm. One-piece machined nonmetallic or solid bronze cages are considered standard for this series. These bearings are appropriate for use with moderate one-directional thrust loads, or combined radial and thrust loads where the thrust load is predominant.

Caution: Single bearings are not to be used where only radial loads are present. For two-direction thrust loads, use duplex bearings.

MRC Bearing Number	Bore		Outside Diameter D		Width B		Fillet Radius ¹⁾				Basic Radial Load Rating ²⁾				Speed Rating ³⁾	
											Dynamic C ⁴⁾		Static C ₀		Grease RPM	Oil RPM
											N	lbf	N	lbf		
7100-KR	10	.3937	26	1.0236	8	.3150	.30	.012	.10	.004	4 620	1 040	2 000	450	23 000	39 000
7101-KR	12	.4724	28	1.1024	8	.3150	.30	.012	.10	.004	4 940	1 110	2 500	562	19 000	32 000
7102-KR	15	.5906	32	1.2598	9	.3543	.30	.012	.10	.004	5 400	1 210	2 900	652	17 000	28 000
7103-KR	17	.6693	35	1.3780	10	.3937	.30	.012	.10	.004	7 610	1 710	4 250	955	15 000	25 000
7104-KR	20	.7874	42	1.6535	12	.4724	.64	.025	.30	.012	9 560	2 150	5 700	1 280	13 000	21 000
7105-KR	25	.9843	47	1.8504	12	.4724	.64	.025	.30	.012	10 600	2 380	6 950	1 560	9 600	16 000
7106-KR	30	1.1811	55	2.1654	13	.5118	1.0	.04	.30	.012	13 800	3 100	9 650	2 170	8 400	14 000
7107-KR	35	1.3780	62	2.4409	14	.5512	1.0	.04	.30	.012	16 800	3 780	12 000	2 700	7 200	12 000
7108-KR	40	1.5748	68	2.6772	15	.5906	1.0	.04	.30	.012	17 200	3 870	13 200	2 970	6 600	11 000
7109-KR	45	1.7717	75	2.9528	16	.6299	1.0	.04	.30	.012	21 200	4 770	17 000	3 820	5 700	9 800
7110-KR	50	1.9685	80	3.1496	16	.6299	1.0	.04	.30	.012	22 100	4 970	18 300	4 110	5 400	9 000
7111-KR	55	2.1654	90	3.5433	18	.7087	1.0	.04	.60	.024	29 600	6 650	25 500	5 730	4 900	8 200
7112-KR	60	2.3622	95	3.7402	18	.7087	1.0	.04	.60	.024	30 700	6 900	27 000	6 070	4 400	7 400
7113-KR	65	2.5591	100	3.9370	18	.7087	1.0	.04	.60	.024	31 200	7 010	29 000	6 520	4 200	7 000
7114-KR	70	2.7559	110	4.3307	20	.7874	1.0	.04	.60	.024	34 500	7 760	35 500	7 980	3 900	6 500
7115-KR	75	2.9528	115	4.5276	20	.7874	1.0	.04	.60	.024	37 700	8 480	37 500	8 430	3 700	6 100
7116-KR	80	3.1496	125	4.9213	22	.8661	1.0	.04	.60	.024	48 800	11 000	49 000	11 000	3 500	5 800
7117-KR	85	3.3465	130	5.1181	22	.8661	1.0	.04	.60	.024	49 400	11 100	52 000	11 700	3 200	5 300
7118-KR	90	3.5433	140	5.5118	24	.9449	1.5	.06	.60	.024	58 500	13 200	61 000	13 700	2 900	4 900
7119-KR	95	3.7402	145	5.7087	24	.9449	1.5	.06	.60	.024	71 500	16 100	72 000	16 200	2 800	4 700
7120-KR	100	3.9370	150	5.9055	24	.9449	1.5	.06	1.0	.040	62 400	14 000	68 000	15 300	2 700	4 500
7121-KR	105	4.1339	160	6.2992	26	1.0236	2.0	.08	1.0	.040	74 100	16 700	80 000	18 000	2 600	4 300
7122-KR	110	4.3307	170	6.6929	28	1.1024	2.0	.08	1.0	.040	87 100	19 600	91 500	20 600	2 500	3 800
7124-KR	120	4.7244	180	7.0866	28	1.1024	2.0	.08	1.0	.040	88 400	19 900	98 000	22 000	2 300	3 800
7126-KR	130	5.1181	200	7.8740	33	1.2992	2.0	.08	1.0	.040	121 000	27 200	134 000	30 100	2 100	3 500
7128-KR	140	5.5118	210	8.2677	33	1.2992	2.0	.08	1.0	.040	121 000	27 200	137 000	30 800	2 000	3 300
7130-KR	150	5.9055	225	8.8583	35	1.3780	2.0	.08	1.0	.040	135 000	30 300	156 000	35 100	1 700	2 900
7132-KR	160	6.2992	240	9.4488	38	1.4961	2.0	.08	1.0	.040	156 000	35 100	180 000	40 500	1 700	2 800
7134-KR	170	6.6929	260	10.2362	42	1.6535	2.0	.08	1.0	.040	186 000	41 800	220 000	49 500	1 600	2 700
7136-KR	180	7.0866	280	11.0236	46	1.8110	2.0	.08	1.0	.040	208 000	46 800	260 000	58 500	1 600	2 600
7138-KR	190	7.4803	290	11.4173	46	1.8110	2.0	.08	1.0	.040	212 000	47 700	270 000	60 700	1 400	2 400
7140-KR	200	7.8740	310	12.2047	51	2.0079	2.0	.08	1.0	.040	238 000	53 500	320 000	71 900	1 400	2 300
7144-KR	220	8.6614	340	13.3858	56	2.2047	2.5	.10	1.0	.040	302 000	67 900	430 000	96 700	1 300	2 200
7148-KR	240	9.4488	360	14.1732	56	2.2047	2.5	.10	1.0	.040	307 000	69 000	455 000	102 000	1 200	2 000
7152-KR	260	10.2362	400	15.7480	65	2.5591	3.0	.12	1.5	.060	377 000	84 800	585 000	132 000	1 100	1 900
7156-KR	280	11.0236	420	16.5354	65	2.5591	3.0	.12	1.5	.060	390 000	87 700	620 000	139 000	1 100	1 900
7160-KR	300	11.8110	460	18.1102	74	2.9134	3.0	.12	1.5	.060	449 000	101 000	765 000	172 000	1 000	1 700
7164-KR	320	12.5984	480	18.8976	74	2.9134	3.0	.12	1.5	.060	462 000	104 000	815 000	183 000	960	1 600

¹⁾ Fillet radius indicates maximum fillet radius on shaft or in housing which bearing corner will clear.

²⁾ For thrust rating multiply C by 1.32 and C₀ by 2.94.

³⁾ Listed values are for machined bronze cage, ABEC-1.

For phenolic composition cage, multiply by 1.33 for both grease and oil. For phenolic composition cage, ABEC-5 or 7, multiply by 1.86 for both grease and oil. For pressed steel cage, ABEC-1, multiply by 0.67 for grease and 0.80 for oil. The speed rating adjustment factors have been determined through historical application and practice. For a more complete explanation, see page 276

⁴⁾ Rating for one million revolutions or 500 hours at 33 1/3 RPM.

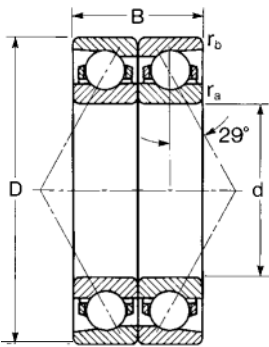

Note: ABEC - 1 & 3 stocked as half-pairs, where available.

"D" indicates a duplex ground half pair matched with an identical half pair and is followed by an additional suffix letter to describe the type of duplex. See pages 236 and 237 for suffix description.

Use these values for back-to-back (DB) or face-to-face (DF) mounting arrangements.

MRC Bearing Number	Bore		Outside Diameter		Width		Fillet Radius ¹⁾				Basic Radial Load Rating ²⁾				Speed Rating ³⁾	
	d mm	in	D mm	in	B mm	in	r _a mm	in	r _b mm	in	Dynamic C _d ⁴⁾		Static C _s		Grease RPM	Oil RPM
											N	lbf	N	lbf		
7100-KRD	10	.3937	26	1.0236	16	.6299	.30	.012	.10	.004	7 610	1 710	4 150	933	24 000	31 000
7101-KRD	12	.4724	28	1.1024	16	.6299	.30	.012	.10	.004	8 060	1 810	5 000	1 120	20 000	26 000
7102-KRD	15	.5906	32	1.2598	18	.7087	.30	.012	.10	.004	8 840	1 990	5 850	1 320	18 000	22 000
7103-KRD	17	.6693	35	1.3780	20	.7874	.30	.012	.10	.004	12 500	2 810	8 500	1 910	15 000	20 000
7104-KRD	20	.7874	42	1.6535	24	.9449	.64	.025	.30	.012	15 600	3 510	11 400	2 560	13 000	17 000
7105-KRD	25	.9843	47	1.8504	24	.9449	.64	.025	.30	.012	17 400	3 910	14 000	3 150	9 600	13 000
7106-KRD	30	1.1811	55	2.1654	26	1.0236	1.0	.04	.30	.012	22 500	5 060	19 300	4 340	8 800	11 000
7107-KRD	35	1.3780	62	2.4409	28	1.1024	1.0	.04	.30	.012	27 600	6 200	24 000	5 400	7 400	9 600
7108-KRD	40	1.5748	68	2.6772	30	1.1811	1.0	.04	.30	.012	28 100	6 320	26 000	5 850	6 800	8 800
7109-KRD	45	1.7717	75	2.9528	32	1.2598	1.0	.04	.30	.012	34 500	7 760	34 000	7 640	6 000	7 800
7110-KRD	50	1.9685	80	3.1496	32	1.2598	1.0	.04	.30	.012	35 800	8 050	36 500	8 210	5 500	7 200
7111-KRD	55	2.1654	90	3.5433	36	1.4173	1.0	.04	.60	.024	47 500	10 700	51 000	11 500	5 000	6 600
7112-KRD	60	2.3622	95	3.7402	36	1.4173	1.0	.04	.60	.024	49 400	11 100	54 000	12 100	4 600	5 900
7113-KRD	65	2.5591	100	3.9370	36	1.4173	1.0	.04	.60	.024	50 700	11 400	58 500	13 200	4 300	5 600
7114-KRD	70	2.7559	110	4.3307	40	1.5748	1.0	.04	.60	.024	55 900	12 600	71 000	16 000	4 000	5 200
7115-KRD	75	2.9528	115	4.5276	40	1.5748	1.0	.04	.60	.024	61 800	13 900	75 000	16 900	3 800	4 900
7116-KRD	80	3.1496	125	4.9213	44	1.7323	1.0	.04	.60	.024	79 300	17 800	98 000	22 000	3 600	4 600
7117-KRD	85	3.3465	130	5.1181	44	1.7323	1.0	.04	.60	.024	80 600	18 100	104 000	23 400	3 300	4 200
7118-KRD	90	3.5433	140	5.5118	48	1.8898	1.5	.06	.60	.024	95 600	21 500	122 000	27 400	3 000	3 900
7119-KRD	95	3.7402	145	5.7087	48	1.8898	1.5	.06	.60	.024	117 000	26 300	143 000	32 100	2 900	3 800
7120-KRD	100	3.9370	150	5.9055	48	1.8898	1.5	.06	1.0	.040	101 000	22 700	137 000	30 800	2 800	3 600
7121-KRD	105	4.1339	160	6.2992	52	2.0472	2.0	.08	1.0	.040	121 000	27 200	160 000	36 000	2 600	3 400
7122-KRD	110	4.3307	170	6.6929	56	2.2047	2.0	.08	1.0	.040	140 000	31 500	183 000	41 100	2 600	3 300
7124-KRD	120	4.7244	180	7.0866	56	2.2047	2.0	.08	1.0	.040	143 000	32 100	196 000	44 100	2 300	3 000
7126-KRD	130	5.1181	200	7.8740	66	2.5984	2.0	.08	1.0	.040	195 000	43 800	270 000	60 700	2 200	2 800
7128-KRD	140	5.5118	210	8.2677	66	2.5984	2.0	.08	1.0	.040	195 000	43 800	270 000	60 700	2 000	2 600
7130-KRD	150	5.9055	225	8.8583	70	2.7559	2.0	.08	1.0	.040	221 000	49 700	315 000	70 800	1 800	2 300
7132-KRD	160	6.2992	240	9.4488	76	2.9921	2.0	.08	1.0	.040	255 000	57 300	360 000	80 900	1 800	2 200
7134-KRD	170	6.6929	260	10.2362	84	3.3071	2.0	.08	1.0	.040	302 000	67 900	440 000	98 900	1 700	2 200
7136-KRD	180	7.0866	280	11.0236	92	3.6220	2.0	.08	1.0	.040	338 000	76 000	520 000	117 000	1 600	2 100
7138-KRD	190	7.4803	290	11.4173	92	3.6220	2.0	.08	1.0	.040	345 000	77 600	540 000	121 000	1 400	1 900
7140-KRD	200	7.8740	310	12.2047	102	4.0157	2.0	.08	1.0	.040	390 000	87 700	640 000	144 000	1 400	1 800
7144-KRD	220	8.6614	340	13.3858	112	4.4094	2.5	.10	1.0	.040	494 000	111 000	865 000	194 000	1 400	1 800
7148-KRD	240	9.4488	360	14.1732	112	4.4094	2.5	.10	1.0	.040	494 000	111 000	915 000	206 000	1 200	1 600
7152-KRD	260	10.2362	400	15.7480	130	5.1181	3.0	.12	1.5	.060	618 000	139 000	1 180 000	265 000	1 200	1 500
7156-KRD	280	11.0236	420	16.5354	130	5.1181	3.0	.12	1.5	.060	637 000	143 000	1 250 000	281 000	1 200	1 500
7160-KRD	300	11.8110	460	18.1102	148	5.8268	3.0	.12	1.5	.060	728 000	164 000	1 580 000	355 000	1 000	1 400
7164-KRD	320	12.5984	480	18.8976	148	5.8268	3.0	.12	1.5	.060	761 000	171 000	1 630 000	366 000	960	1 300

¹⁾ Fillet radius indicates maximum fillet radius on shaft or in housing which bearing corner will clear.

²⁾ For thrust rating multiply C by 0.81 and C_s by 1.47.

³⁾ Listed values are for machined bronze cage, ABEC-1.

For phenolic composition cage, multiply by 1.33 for both grease and oil. For phenolic composition cage, ABEC-5 or 7, multiply by 1.86 for both grease and oil. For pressed steel cage, ABEC-1, multiply by 0.67 for grease and 0.80 for oil. The speed rating adjustment factors have been determined through historical application and practice. For a more complete explanation, see page 276

⁴⁾ Rating for one million revolutions or 500 hours at 33 1/3 RPM.

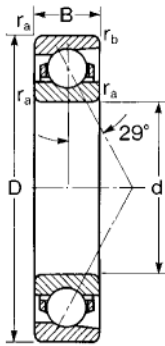

The 7200 Series contains single-row angular contact bearings with a counterbored outer ring. Bore sizes range from 10 mm to 320 mm, and most of these bearings are available with a two-piece pressed steel cage, or a one-piece nonmetallic or solid bronze cage. 7000 Series bearings are designed with an initial contact angle of 29 degrees, although some small sizes may have a lesser angle. 7200 Series bearings can be used with moderate to heavy one-directional thrust loads, or combined radial and thrust loads where the thrust load is predominant.

Caution: Single bearings are not to be used where only radial loads are present. For two-direction thrust loads, use duplex bearings.

MRC Bearing Number	Bore		Outside Diameter D		Width B		Fillet Radius ¹⁾				Basic Radial Load Rating ²⁾				Speed Rating ³⁾	
											Dynamic C _d		Static C _s		Grease RPM	Oil RPM
											N	lbf	N	lbf		
7200	10	.3937	30	1.1811	9	.3543	.64	.025	.30	.012	5 400	1 210	2 750	618	28 000	36 000
7201	12	.4724	32	1.2598	10	.3937	.64	.025	.30	.012	6 240	1 400	3 200	719	22 000	29 000
7202	15	.5906	35	1.3780	11	.4331	.64	.025	.30	.012	9 040	2 030	4 750	1 070	20 000	26 000
7203	17	.6693	40	1.5748	12	.4724	.64	.025	.30	.012	11 900	2 680	6 550	1 470	18 000	23 000
7204	20	.7874	47	1.8504	14	.5512	.64	.04	.60	.024	12 700	2 860	7 200	1 620	15 000	19 000
7205	25	.9843	52	2.0472	15	.5906	1.0	.04	.60	.024	15 300	3 440	9 500	2 140	12 000	16 000
7206	30	1.1811	62	2.4409	16	.6299	1.0	.04	.60	.024	16 800	3 780	11 800	2 650	10 000	13 000
7207	35	1.3780	72	2.8346	17	.6693	1.0	.04	.60	.024	23 400	5 260	17 000	3 820	9 200	12 000
7208	40	1.5748	80	3.1496	18	.7087	1.0	.04	.60	.024	30 700	6 900	22 800	5 130	7 700	10 000
7209	45	1.7717	85	3.3465	19	.7480	1.0	.04	.60	.024	30 700	6 900	23 200	5 220	7 300	9 500
7210	50	1.9685	90	3.5433	20	.7874	1.0	.04	.60	.024	33 200	7 460	27 000	6 070	6 400	8 300
7211	55	2.1654	100	3.9370	21	.8268	1.5	.06	1.0	.040	48 800	11 000	37 500	8 430	6 000	7 800
7212	60	2.3622	110	4.3307	22	.8661	1.5	.06	1.0	.040	52 700	11 800	44 000	9 890	5 400	7 000
7213	65	2.5591	120	4.7244	23	.9055	1.5	.06	1.0	.040	63 700	14 300	54 000	12 100	4 900	6 400
7214	70	2.7559	125	4.9213	24	.9449	1.5	.06	1.0	.040	63 700	14 300	55 000	12 400	4 600	6 000
7215	75	2.9528	130	5.1181	25	.9843	1.5	.06	1.0	.040	79 300	17 800	69 500	15 600	4 300	5 600
7216	80	3.1496	140	5.5118	26	1.0236	2.0	.08	1.0	.040	74 100	16 700	67 000	15 100	4 100	5 300
7217	85	3.3465	150	5.9055	28	1.1024	2.0	.08	1.0	.040	90 400	20 300	83 000	18 700	3 800	4 900
7218	90	3.5433	160	6.2992	30	1.1811	2.0	.08	1.0	.040	117 000	26 300	118 000	26 500	3 600	4 700
7219	95	3.7402	170	6.6929	32	1.2598	2.0	.08	1.0	.040	121 000	27 200	114 000	25 600	3 500	4 500
7220	100	3.9370	180	7.0866	34	1.3386	2.0	.08	1.0	.040	138 000	31 000	129 000	29 000	3 200	4 100
7221	105	4.1339	190	7.4803	36	1.4173	2.0	.08	1.0	.040	148 000	33 300	137 000	30 800	3 000	3 900
7222	110	4.3307	200	7.8740	38	1.4961	2.0	.08	1.0	.040	163 000	36 600	156 000	35 100	2 900	3 800
7224	120	4.7244	215	8.4646	40	1.5748	2.0	.08	1.0	.040	174 000	39 100	176 000	39 600	2 700	3 500
7226	130	5.1181	230	9.0551	40	1.5748	2.5	.10	1.0	.040	195 000	43 800	208 000	46 800	2 500	3 200
7228	140	5.5118	250	9.8425	42	1.6535	2.5	.10	1.0	.040	208 000	46 800	232 000	52 200	2 300	3 000
7230	150	5.9055	270	10.6299	45	1.7717	2.5	.10	1.0	.040	242 000	54 400	280 000	62 900	2 100	2 700
7232	160	6.2992	290	11.4173	48	1.8898	2.5	.10	1.0	.040	270 000	60 700	325 000	73 100	2 000	2 600
7234	170	6.6929	310	12.2047	52	2.0472	3.0	.12	1.0	.040	286 000	64 300	365 000	82 100	1 900	2 500
7236	180	7.0866	320	12.5984	52	2.0472	3.0	.12	1.0	.040	302 000	67 900	390 000	87 700	1 900	2 400
7238	190	7.4803	340	13.3858	55	2.1654	3.0	.12	1.0	.040	332 000	74 600	450 000	101 000	1 700	2 200
7240	200	7.8740	360	14.1732	58	2.2835	3.0	.12	1.0	.040	351 000	78 900	490 000	110 000	1 600	2 100
7242	210	8.2677	380	14.9606	61	2.4016	3.0	.12	1.0	.040	390 000	87 700	560 000	126 000	1 500	2 000
7244	220	8.6614	400	15.7480	65	2.5591	3.0	.12	1.0	.040	403 000	90 600	600 000	135 000	1 500	2 000
7246	230	9.0551	420	16.5354	68	2.6772	3.0	.12	1.0	.040	442 000	99 400	670 000	151 000	1 500	1 900
7248	240	9.4488	440	17.3228	72	2.8346	3.0	.12	1.0	.040	475 000	107 000	750 000	169 000	1 400	1 800
7250	250	9.8425	460	18.1102	76	2.9921	4.0	.16	1.5	.060	520 000	117 000	830 000	187 000	1 400	1 800
7252	260	10.2362	480	18.8976	80	3.1496	4.0	.16	1.5	.060	559 000	126 000	915 000	206 000	1 300	1 700
7256	280	11.0236	500	19.6850	80	3.1496	4.0	.16	1.5	.060	572 000	129 000	980 000	220 000	1 300	1 700
7260	300	11.8110	540	21.2598	85	3.3465	4.0	.16	1.5	.060	618 000	139 000	1 100 000	247 000	1 200	1 600
7264	320	12.5984	580	22.8346	92	3.6220	4.0	.16	1.5	.060	650 000	146 000	1 220 000	274 000	1 200	1 500

¹⁾ Fillet radius indicates maximum fillet radius on shaft or in housing which bearing corner will clear.

²⁾ For thrust rating multiply C by 1.32 and C₀ by 2.94.

³⁾ Listed values are for machined bronze cage, ABEC-1.

For phenolic composition cage, multiply by 1.33 for both grease and oil. For phenolic composition cage, ABEC-5 or 7, multiply by 1.86 for both grease and oil. For pressed steel cage, ABEC-1, multiply by 0.67 for grease and 0.80 for oil. The speed rating adjustment factors have been determined through historical application and practice. For a more complete explanation, see page 276

⁴⁾ Rating for one million revolutions or 500 hours at 33 1/3 RPM.

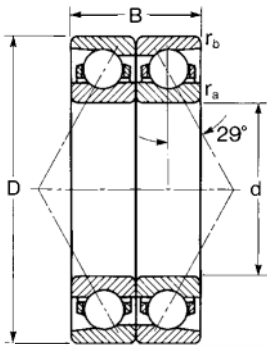

Note: ABEC-1 & 3 stocked as half-pairs, where available.

“D” indicates a duplex ground half pair matched with an identical half pair and is followed by an additional suffix letter to describe the type of duplex. See pages 236 and 237 for suffix description.

For duplex sets of 7000 and 9000 series bearings see page 239

Use these values for back-to-back (DB) or face-to-face (DF) mounting arrangements.

MRC Bearing Number	Bore		Outside Diameter D		Width B		Fillet Radius ¹⁾				Basic Radial Load Rating ²⁾				Speed Rating ³⁾	
											Dynamic C _d		Static C ₀		Grease	Oil
	d	mm	in	mm	in	mm	in	mm	in	mm	in	N	lbf	N	lbf	RPM
7200-D	10	.3937	30	1.1811	18	.7087	.64	.025	.30	.012	8 840	1 900	5 500	1 240	22 000	29 000
7201-D	12	.4724	32	1.2598	20	.7874	.64	.025	.30	.012	10 100	2 270	6 400	1 440	18 000	23 000
7202-D	15	.5906	35	1.3780	22	.8661	.64	.025	.30	.012	14 800	3 330	9 500	2 140	16 000	21 000
7203-D	17	.6693	40	1.5748	24	.9449	.64	.025	.30	.012	19 500	4 380	13 200	2 970	14 000	18 000
7204-D	20	.7874	47	1.8504	28	1.1024	1.0	.04	.60	.024	20 800	4 680	14 600	3 280	12 000	15 000
7205-D	25	.9843	52	2.0472	30	1.1811	1.0	.04	.60	.024	25 100	5 640	19 000	4 270	9 600	13 000
7206-D	30	1.1811	62	2.4409	32	1.2598	1.0	.04	.60	.024	27 600	6 200	23 600	5 310	8 000	10 000
7207-D	35	1.3780	72	2.8346	34	1.3386	1.0	.04	.60	.024	37 700	8 480	34 000	7 640	7 400	9 600
7208-D	40	1.5748	80	3.1496	36	1.4173	1.0	.04	.60	.024	49 400	11 100	45 500	10 200	6 200	8 000
7209-D	45	1.7717	85	3.3465	38	1.4961	1.0	.04	.60	.024	49 400	11 100	46 500	10 500	5 800	7 600
7210-D	50	1.9685	90	3.5433	40	1.5748	1.0	.04	.60	.024	54 000	12 100	54 000	12 100	5 100	6 600
7211-D	55	2.1654	100	3.9370	42	1.6535	1.5	.06	1.0	.040	79 300	17 800	75 000	16 900	4 800	6 200
7212-D	60	2.3622	110	4.3307	44	1.7323	1.5	.06	1.0	.040	85 200	19 100	88 000	19 800	4 300	5 600
7213-D	65	2.5591	120	4.7244	46	1.8110	1.5	.06	1.0	.040	104 000	23 400	110 000	24 700	3 900	5 100
7214-D	70	2.7559	125	4.9213	48	1.8898	1.5	.06	1.0	.040	104 000	23 400	110 000	24 700	3 700	4 800
7215-D	75	2.9528	130	5.1181	50	1.9685	1.5	.06	1.0	.040	130 000	29 200	140 000	31 500	3 400	4 500
7216-D	80	3.1496	140	5.5118	52	2.0472	2.0	.08	1.0	.040	121 000	27 200	134 000	30 100	3 300	4 200
7217-D	85	3.3465	150	5.9055	56	2.2047	2.0	.08	1.0	.040	148 000	33 300	166 000	37 300	3 000	3 900
7218-D	90	3.5433	160	6.2992	60	2.3622	2.0	.08	1.0	.040	190 000	42 700	236 000	53 100	2 900	3 800
7219-D	95	3.7402	170	6.6929	64	2.5197	2.0	.08	1.0	.040	199 000	44 700	228 000	51 300	2 800	3 600
7220-D	100	3.9370	180	7.0866	68	2.6772	2.0	.08	1.0	.040	225 000	50 600	260 000	58 500	2 600	3 300
7221-D	105	4.1339	190	7.4803	72	2.8346	2.0	.08	1.0	.040	242 000	54 400	295 000	66 300	2 400	3 100
7222-D	110	4.3307	200	7.8740	76	2.9921	2.0	.08	1.0	.040	265 000	59 600	310 000	69 700	2 300	3 000
7224-D	120	4.7244	215	8.4646	80	3.1496	2.0	.08	1.0	.040	281 000	63 200	355 000	79 800	2 200	2 800
7226-D	130	5.1181	230	9.0551	80	3.1496	2.5	.10	1.0	.040	319 000	71 700	415 000	93 300	2 000	2 600
7228-D	140	5.5118	250	9.8425	84	3.3071	2.5	.10	1.0	.040	338 000	76 000	465 000	105 000	1 800	2 400
7230-D	150	5.9055	270	10.6299	90	3.5435	2.5	.10	1.0	.040	397 000	89 200	560 000	126 000	1 700	2 200
7232-D	160	6.2992	290	11.4173	96	3.7795	2.5	.10	1.0	.040	442 000	99 400	670 000	135 000	1 600	2 100
7234-D	170	6.6929	310	12.2047	104	4.0945	3.0	.12	1.0	.040	468 000	105 000	735 000	165 000	1 500	2 000
7236-D	180	7.0866	320	12.5984	104	4.0945	3.0	.12	1.0	.040	494 000	111 000	780 000	175 000	1 500	1 900
7238-D	190	7.4803	340	13.3858	110	4.3307	3.0	.12	1.0	.040	540 000	121 000	900 000	202 000	1 400	1 800
7240-D	200	7.8740	360	14.1732	116	4.5669	3.0	.12	1.0	.040	572 000	129 000	965 000	217 000	1 300	1 700
7242-D	210	8.2677	380	14.9606	122	4.8031	3.0	.12	1.0	.040	637 000	143 000	1 120 000	252 000	1 200	1 600
7244-D	220	8.6614	400	15.7480	130	5.1181	3.0	.12	1.0	.040	650 000	146 000	1 200 000	270 000	1 200	1 600
7246-D	230	9.0551	420	16.5354	136	5.3543	3.0	.12	1.0	.040	715 000	161 000	1 340 000	301 000	1 200	1 500
7248-D	240	9.4488	440	17.3228	144	5.6693	3.0	.12	1.0	.040	780 000	175 000	1 500 000	337 000	1 100	1 400
7250-D	250	9.8425	460	18.1102	152	5.9842	4.0	.16	1.5	.060	852 000	192 000	1 660 000	373 000	1 100	1 400
7252-D	260	10.2362	480	18.8976	160	6.2992	4.0	.16	1.5	.060	904 000	203 000	1 830 000	411 000	1 000	1 400
7256-D	280	11.0236	500	19.6850	160	6.2992	4.0	.16	1.5	.060	936 000	210 000	2 000 000	450 000	1 000	1 400
7260-D	300	11.8110	540	21.2598	170	6.6929	4.0	.16	1.5	.060	1 010 000	227 000	2 200 000	495 000	960	1 300
7264-D	320	12.5984	580	22.8346	184	7.2441	4.0	.16	1.5	.060	1 060 000	238 000	2 400 000	540 000	960	1 200

¹⁾ Fillet radius indicates maximum fillet radius on shaft or in housing which bearing corner will clear.

²⁾ For thrust rating multiply C by 0.81 and C₀ by 1.47.

³⁾ Listed values are for machined bronze cage, ABEC-1.

For phenolic composition cage, multiply by 1.33 for both grease and oil. For phenolic composition cage, ABEC-5 or 7, multiply by 1.86 for both grease and oil. For pressed steel cage, ABEC-1, multiply by 0.67 for grease and 0.80 for oil. The speed rating adjustment factors have been determined through historical application and practice. For a more complete explanation, see page 276

⁴⁾ Rating for one million revolutions or 500 hours at 33 1/3 RPM.

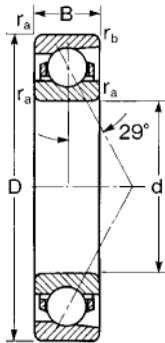

7300 series bearings have the same ring and ball cage construction as the 7200 Series but are heavier sectioned bearings with a ball complement capable of handling heavier loads. 7300 Series are listed with bore sizes from 10 mm to 280 mm. For two directional thrust loads, use duplex bearings.

Caution: Single bearings are not to be used where only radial loads are present. For two-direction thrust loads, use duplex bearings.

MRC Bearing Number	Bore		Outside Diameter D		Width B		Fillet Radius ¹⁾				Basic Radial Load Rating ²⁾				Speed Rating ³⁾	
											Dynamic C _d ⁴⁾		Static C ₀		Grease RPM	Oil RPM
	d mm	in	mm	in	mm	in	r _a mm	in	r _b mm	in	N	lbf	N	lbf		
7300	10	.3937	36	1.3780	11	.4331	.64	.025	.60	.024	6 370	1 430	3 200	719	24 000	31 000
7301	12	.4724	37	1.4567	12	.4724	1.0	.04	.60	.024	7 020	1 580	3 750	843	19 000	25 000
7302	15	.5906	42	1.6535	13	.5118	1.0	.04	.60	.024	13 500	3 030	7 100	1 600	16 000	21 000
7303	17	.6693	47	1.8504	14	.5512	1.0	.04	.60	.024	15 900	3 570	8 650	1 940	15 000	19 000
7304	20	.7874	52	2.0472	15	.5906	1.0	.04	.60	.024	18 600	4 180	10 600	2 380	13 000	17 000
7305	25	.9843	62	2.4409	17	.6693	1.0	.04	.60	.024	21 200	4 770	13 700	3 080	11 000	14 000
7306	30	1.1811	72	2.8346	19	.7480	1.0	.04	.60	.024	28 100	6 320	18 600	4 180	9 200	12 000
7307	35	1.3780	80	3.1496	21	.8268	1.5	.06	1.0	.040	35 800	8 050	24 000	5 400	8 500	11 000
7308	40	1.5748	90	3.5433	23	.9055	1.5	.06	1.0	.040	44 200	9 940	30 500	6 860	7 300	9 500
7309	45	1.7717	100	3.9370	25	.9843	1.5	.06	1.0	.040	52 700	11 800	37 500	8 430	6 400	8 300
7310	50	1.9685	110	4.3307	27	1.0630	2.0	.08	1.0	.040	74 100	16 700	53 000	11 900	5 800	7 500
7311	55	2.1654	120	4.7244	29	1.1417	2.0	.08	1.0	.040	85 200	19 200	62 000	13 900	5 100	6 600
7312	60	2.3622	130	5.1181	31	1.2205	2.0	.08	1.0	.040	97 500	21 900	72 000	16 200	4 900	6 400
7313	65	2.5591	140	5.5118	33	1.2992	2.0	.08	1.0	.040	108 000	24 300	86 500	19 400	4 600	6 000
7314	70	2.7559	150	5.9055	35	1.3780	2.0	.08	1.0	.040	111 000	25 000	85 000	19 100	4 100	5 300
7315	75	2.9528	160	6.2992	37	1.4567	2.0	.08	1.0	.040	138 000	31 000	114 000	25 600	3 900	5 000
7316	80	3.1496	170	6.6929	39	1.5354	2.0	.08	1.0	.040	143 000	32 100	120 000	27 000	3 600	4 700
7317	85	3.3465	180	7.0866	41	1.6142	2.5	.10	1.0	.040	163 000	36 600	143 000	32 100	3 500	4 500
7318	90	3.5433	190	7.4803	43	1.6299	2.5	.10	1.0	.040	168 000	37 800	150 000	33 700	3 200	4 200
7319	95	3.7402	200	7.8740	45	1.7717	2.5	.10	1.0	.040	178 000	40 000	166 000	37 300	3 100	4 000
7320	100	3.9370	215	8.4646	47	1.8504	2.5	.10	1.0	.040	190 000	42 700	183 000	41 100	3 000	3 900
7321	105	4.1339	225	8.8583	49	1.9291	2.5	.10	1.0	.040	203 000	45 600	200 000	45 000	2 900	3 800
7322	110	4.3307	240	9.4488	50	1.9685	2.5	.10	1.0	.040	229 000	51 500	236 000	53 100	2 700	3 500
7324	120	4.7244	260	10.2362	55	2.1654	2.5	.10	1.0	.040	260 000	58 500	275 000	61 800	2 500	3 200
7326	130	5.1181	280	11.0236	58	2.2835	3.0	.12	1.0	.040	286 000	64 300	320 000	71 900	2 300	3 000
7328	140	5.5118	300	11.8110	62	2.4409	3.0	.12	1.0	.040	312 000	70 100	375 000	84 300	2 200	2 800
7330	150	5.9055	320	12.5984	65	2.5591	3.0	.12	1.0	.040	345 000	77 600	430 000	96 700	2 000	2 600
7332	160	6.2992	340	13.3858	68	2.6772	3.0	.12	1.0	.040	377 000	84 800	490 000	110 000	1 900	2 500
7334	170	6.6929	360	14.1732	72	2.8346	3.0	.12	1.0	.040	397 000	89 200	520 000	117 000	1 900	2 400
7336	180	7.0866	380	14.9606	75	2.9528	3.0	.12	1.0	.040	423 000	95 100	585 000	132 000	1 800	2 300
7338	190	7.4803	400	15.7480	78	3.0709	4.0	.16	1.5	.060	462 000	104 000	655 000	147 000	1 600	2 100
7340	200	7.8740	420	16.5354	80	3.1496	4.0	.16	1.5	.060	494 000	111 000	720 000	162 000	1 500	2 000
7342	210	8.2677	440	17.3228	84	3.3071	4.0	.16	1.5	.060	527 000	118 000	800 000	180 000	1 500	1 900
7344	220	8.6614	460	18.1102	88	3.4646	4.0	.16	1.5	.060	559 000	126 000	865 000	194 000	1 400	1 800
7348	240	9.4488	500	19.6850	95	3.7402	4.0	.16	1.5	.060	605 000	136 000	965 000	217 000	1 400	1 700
7352	260	10.2362	540	21.2598	102	4.0157	5.0	.20	2.0	.080	663 000	149 000	1 140 000	256 000	1 300	1 600
7356	280	11.0236	580	22.8346	108	4.2520	5.0	.20	2.0	.080	741 000	167 000	1 340 000	301 000	1 200	1 500

¹⁾ Fillet radius indicates maximum fillet radius on shaft or in housing which bearing corner will clear.

²⁾ For thrust rating multiply C by 1.32 and C₀ by 2.94.

³⁾ Listed values are for machined bronze cage, ABEC-1.

For phenolic composition cage, multiply by 1.33 for both grease and oil. For phenolic composition cage, ABEC-5 or 7, multiply by 1.86 for both grease and oil. For pressed steel cage, ABEC-1, multiply by 0.67 for grease and 0.80 for oil. The speed rating adjustment factors have been determined through historical application and practice. For a more complete explanation, see page 276

⁴⁾ Rating for one million revolutions or 500 hours at 33 1/3 RPM.

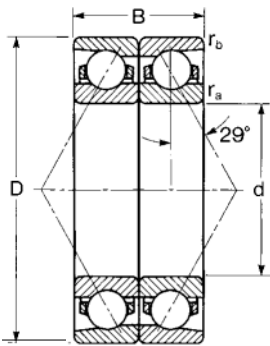

“D” indicates a duplex ground half pair matched with an identical half pair and is followed by an additional suffix letter to describe the type of duplex. See pages 236 and 237 for suffix description.

For duplex sets of 7000 and 9000 series bearings see page 239

Note: ABEC-1 & 3 stocked as half-pairs where available.

Use these values for back-to-back (DB) or face-to-face (DF) mounting arrangements.

MRC Bearing Number	Bore		Outside Diameter D		Width B		Fillet Radius ¹⁾				Basic Radial Load Rating ²⁾				Speed Rating ³⁾	
											Dynamic C _d ⁴⁾		Static C ₀		Grease	Oil
	mm	in	mm	in	mm	in	mm	in	mm	in	N	lbf	N	lbf	RPM	RPM
7300-D	10	.3937	36	1.3780	22	.8661	.64	.025	.60	.024	10 400	2 340	6 400	1 440	19 000	25 000
7301-D	12	.4724	37	1.4567	24	.9449	1.0	.04	.60	.024	11 400	2 560	7 500	1 690	15 000	20 000
7302-D	15	.5906	42	1.6535	26	1.0236	1.0	.04	.60	.024	21 600	4 860	14 300	3 210	13 000	17 000
7303-D	17	.6693	47	1.8504	28	1.1024	1.0	.04	.60	.024	26 000	5 850	17 300	3 890	12 000	15 000
7304-D	20	.7874	52	2.0472	30	1.1811	1.0	.04	.60	.024	30 200	6 790	21 200	4 770	10 000	14 000
7305-D	25	.9843	62	2.4409	34	1.3386	1.0	.04	.60	.024	34 500	7 760	27 000	6 070	8 800	11 000
7306-D	30	1.1811	72	2.8346	38	1.4961	1.0	.04	.60	.024	46 200	10 400	37 500	8 430	7 400	9 600
7307-D	35	1.3780	80	3.1496	42	1.6535	1.5	.06	1.0	.040	58 500	13 200	48 000	10 800	6 800	8 800
7308-D	40	1.5748	90	3.5433	46	1.8110	1.5	.06	1.0	.040	71 500	16 100	61 000	13 700	5 800	7 600
7309-D	45	1.7717	100	3.9370	50	1.9685	1.5	.06	1.0	.040	85 200	19 200	75 000	16 900	5 100	6 600
7310-D	50	1.9685	110	4.3307	54	2.1260	2.0	.08	1.0	.040	121 000	27 200	106 000	23 800	4 600	6 000
7311-D	55	2.1654	120	4.7244	58	2.2835	2.0	.08	1.0	.040	140 000	31 500	125 000	28 100	4 100	5 300
7312-D	60	2.3622	130	5.1181	62	2.4409	2.0	.08	1.0	.040	159 000	35 700	146 000	32 800	3 900	5 100
7313-D	65	2.5591	140	5.5118	66	2.5984	2.0	.08	1.0	.040	178 000	40 000	173 000	38 900	3 700	4 800
7314-D	70	2.7559	150	5.9055	70	2.7559	2.0	.08	1.0	.040	182 000	40 900	170 000	38 200	3 300	4 200
7315-D	75	2.9528	160	6.2992	74	2.9134	2.0	.08	1.0	.040	225 000	50 600	228 000	51 300	3 100	4 000
7316-D	80	3.1496	170	6.6929	78	3.0709	2.0	.08	1.0	.040	234 000	52 600	240 000	54 000	2 900	3 800
7317-D	85	3.3465	180	7.0866	82	3.2283	2.5	.10	1.0	.040	265 000	59 600	285 000	64 100	2 800	3 600
7318-D	90	3.5433	190	7.4803	86	3.3858	2.5	.10	1.0	.040	276 000	62 000	300 000	67 400	2 600	3 400
7319-D	95	3.7402	200	7.8740	90	3.5433	2.5	.10	1.0	.040	291 000	65 400	325 000	73 100	2 500	3 200
7320-D	100	3.9370	215	8.4646	94	3.7008	2.5	.10	1.0	.040	312 000	70 100	365 000	82 100	2 400	3 100
7321-D	105	4.1339	225	8.8583	98	3.8583	2.5	.10	1.0	.040	332 000	74 600	400 000	89 900	2 300	3 000
7322-D	110	4.3307	240	9.4488	100	3.9370	2.5	.10	1.0	.040	371 000	83 400	475 000	107 000	2 200	2 800
7324-D	120	4.7244	260	10.2362	110	4.3307	2.5	.10	1.0	.040	423 000	95 100	560 000	126 000	2 000	2 600
7326-D	130	5.1181	280	11.0236	116	4.5669	3.0	.12	1.0	.040	468 000	105 000	640 000	144 000	1 800	2 400
7328-D	140	5.5118	300	11.8110	124	4.8819	3.0	.12	1.0	.040	507 000	114 000	735 000	165 000	1 800	2 200
7330-D	150	5.9055	320	12.5984	130	5.1181	3.0	.12	1.0	.040	559 000	126 000	865 000	194 000	1 600	2 100
7332-D	160	6.2992	340	13.3858	136	5.3543	3.0	.12	1.0	.040	618 000	139 000	965 000	217 000	1 500	2 000
7334-D	170	6.6929	360	14.1732	144	5.6693	3.0	.12	1.0	.040	650 000	146 000	1 040 000	234 000	1 500	1 900
7336-D	180	7.0866	380	14.9606	150	5.9055	3.0	.12	1.0	.040	689 000	155 000	1 160 000	261 000	1 400	1 800
7338-D	190	7.4803	400	15.7480	156	6.1417	4.0	.16	1.5	.060	761 000	171 000	1 290 000	270 000	1 300	1 700
7340-D	200	7.8740	420	16.5354	160	6.2992	4.0	.16	1.5	.060	806 000	181 000	1 430 000	321 000	1 200	1 600
7342-D	210	8.2677	440	17.3228	168	6.6142	4.0	.16	1.5	.060	852 000	192 000	1 600 000	360 000	1 200	1 500
7344-D	220	8.6614	460	18.1102	176	6.9291	4.0	.16	1.5	.060	904 000	203 000	1 730 000	389 000	1 100	1 400
7348-D	240	9.4488	500	19.6850	190	7.4803	4.0	.16	1.5	.060	975 000	219 000	1 930 000	434 000	1 000	1 400
7352-D	260	10.2362	540	21.2598	204	8.0315	5.0	.20	2.0	.080	1 080 000	243 000	2 280 000	513 000	960	1 300
7356-D	280	11.0236	580	22.8346	216	8.5039	5.0	.20	2.0	.080	1 210 000	272 000	2 650 000	596 000	960	1 200

¹⁾ Fillet radius indicates maximum fillet radius on shaft or in housing which bearing corner will clear.

²⁾ For thrust rating multiply C by 0.81 and C₀ by 1.47.

³⁾ Listed values are for machined bronze cage, ABEC-1.

For phenolic composition cage, multiply by 1.33 for both grease and oil. For phenolic composition cage, ABEC-5 or 7, multiply by 1.86 for both grease and oil. For pressed steel cage, ABEC-1, multiply by 0.67 for grease and 0.80 for oil. The speed rating adjustment factors have been determined through historical application and practice. For a more complete explanation, see page 276

⁴⁾ Rating for one million revolutions or 500 hours at 33 1/3 RPM.

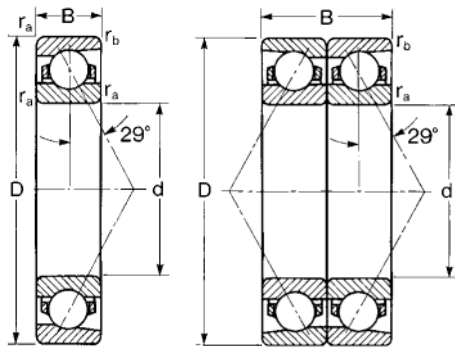

Note: ABEC 1 & 3 stocked as half-pairs where available.

7400 Series bearings are similar to the 7200 and 7300 Series but are heavier sectioned and are used for heavy one-directional thrust loads or combined radial and thrust loads where the thrust load is predominant.

"D" indicates a duplex ground half pair matched with an identical half pair and is followed by an additional suffix letter to describe the type of duplex. See pages 236 and 237 for suffix description.

Caution: Single bearings are not to be used where only radial loads are present. For two-direction thrust loads, use duplex bearings.

Values for -D bearings are for back-to-back or face-to-face (DF) mounting arrangements.

MRC Bearing Number	Bore d mm in		Outside Diameter D mm in		Width B mm in		Fillet Radius ¹⁾ r _a r _b mm in mm in				Basic Radial Load Rating ²⁾				Speed Rating ³⁾	
											Dynamic C _r ⁴⁾		Static C ₀		Grease RPM	Oil RPM
											N	lbf	N	lbf		
7403	17	.6693	62	2.4409	17	.6693	1.0	.04	.60	.024	26 000	5 850	13 700	3 080	14 000	18 000
7404	20	.7874	72	2.8346	19	.7480	1.0	.04	.60	.024	32 500	7 310	17 600	3 960	12 000	15 000
7405	25	.9843	80	3.1496	21	.8268	1.5	.06	1.0	.040	42 300	9 510	24 500	5 510	9 200	12 000
7406	30	1.1811	90	3.5433	23	.9055	1.5	.06	1.0	.040	54 000	12 100	34 000	7 640	7 700	10 000
7407	35	1.3780	100	3.9370	25	.9843	1.5	.06	1.0	.040	63 700	14 300	40 500	9 100	6 600	8 500
7408	40	1.5748	110	4.3307	27	1.0630	2.0	.08	1.0	.040	74 100	16 700	49 000	11 000	5 400	7 700
7409	45	1.7717	120	4.7244	29	1.1417	2.0	.08	1.0	.040	85 200	19 200	57 000	12 800	5 300	6 900
7410	50	1.9685	130	5.1181	31	1.2205	2.0	.08	1.0	.040	95 600	21 500	72 000	16 200	4 900	6 400
7411	55	2.1654	140	5.5118	33	1.2992	2.0	.08	1.0	.040	108 000	24 300	78 000	17 500	4 500	5 800
7412	60	2.3622	150	5.9055	35	1.3780	2.0	.08	1.0	.040	127 000	28 600	93 000	20 900	4 100	5 300
7413	65	2.5591	160	6.2992	37	1.4567	2.0	.08	1.0	.040	138 000	31 000	106 000	23 800	3 800	4 900
7414	70	2.7559	180	7.0866	42	1.6535	2.5	.10	1.0	.040	168 000	37 800	140 000	31 500	3 500	4 600
7415	75	2.9528	190	7.4803	45	1.7717	2.5	.10	1.0	.040	182 000	40 900	156 000	35 100	3 300	4 300
7416	80	3.1496	200	7.8740	48	1.8898	2.5	.10	1.0	.040	190 000	42 700	170 000	38 200	3 200	4 100
7417	85	3.3465	210	8.2677	52	2.0472	3.0	.12	1.0	.040	203 000	45 600	186 000	41 800	2 900	3 800
7418	90	3.5433	225	8.8583	54	2.1260	3.0	.12	1.0	.040	229 000	51 500	220 000	49 500	2 700	3 500
7419	95	3.7402	250	9.8425	55	2.1654	3.0	.12	1.0	.040	255 000	57 300	255 000	57 300	2 500	3 300
7420	100	3.9370	265	10.4331	60	2.3622	3.0	.12	1.0	.040	276 000	62 000	290 000	65 200	2 400	3 200
7421	105	4.1339	290	11.4173	65	2.5591	3.0	.12	1.0	.040	332 000	74 600	325 000	73 100	2 300	3 000
7422	110	4.3307	320	12.5984	70	2.7559	3.0	.12	1.0	.040	371 000	83 400	390 000	87 700	2 200	2 900
7400-D																
7403-D	17	.6693	62	2.4409	34	1.3386	1.0	.04	.60	.024	42 300	9 510	27 000	6 070	11 000	14 000
7404-D	20	.7874	72	2.8346	38	1.4961	1.0	.04	.60	.024	52 700	11 800	35 500	7 980	9 600	12 000
7405-D	25	.9843	80	3.1496	42	1.6535	1.5	.06	1.0	.040	68 900	15 500	49 000	11 000	7 400	9 600
7406-D	30	1.1811	90	3.5433	46	1.8110	1.5	.06	1.0	.040	88 400	19 900	68 000	15 300	6 200	8 000
7407-D	35	1.3780	100	3.9370	50	1.9685	1.5	.06	1.0	.040	104 000	23 400	81 500	18 300	5 300	6 800
7408-D	40	1.5748	110	4.3307	54	2.1260	2.0	.08	1.0	.040	121 000	27 200	96 500	21 700	4 300	6 200
7409-D	45	1.7717	120	4.7244	58	2.2835	2.0	.08	1.0	.040	138 000	31 000	114 000	25 600	4 200	5 500
7410-D	50	1.9685	130	5.1181	62	2.4409	2.0	.08	1.0	.040	156 000	35 100	146 000	32 800	3 900	5 100
7411-D	55	2.1654	140	5.5118	66	2.5984	2.0	.08	1.0	.040	178 000	40 000	156 000	35 100	3 600	4 600
7412-D	60	2.3622	150	5.9055	70	2.7559	2.0	.08	1.0	.040	203 000	45 600	190 000	42 700	3 300	4 200
7413-D	65	2.5591	160	6.2992	74	2.9134	2.0	.08	1.0	.040	225 000	50 600	275 000	61 800	3 000	3 900
7414-D	70	2.7559	180	7.0866	84	3.3071	2.5	.10	1.0	.040	276 000	62 000	280 000	62 900	2 800	3 700
7415-D	75	2.9528	190	7.4803	90	3.5433	2.5	.10	1.0	.040	291 000	65 400	310 000	69 700	2 600	3 400
7416-D	80	3.1496	200	7.8740	96	3.7795	2.5	.10	1.0	.040	312 000	70 100	340 000	76 400	2 500	3 300
7417-D	85	3.3465	210	8.2677	104	4.0945	3.0	.12	1.0	.040	332 000	74 200	375 000	84 300	2 300	3 000
7418-D	90	3.5433	225	8.8583	108	4.2520	3.0	.12	1.0	.040	371 000	83 400	440 000	98 900	2 200	2 800
7419-D	95	3.7402	250	9.8425	110	4.3307	3.0	.12	1.0	.040	410 000	92 200	510 000	115 000	2 000	2 600
7420-D	100	3.9370	265	10.4331	120	4.7244	3.0	.12	1.0	.040	449 000	101 000	585 000	132 000	1 900	2 600
7421-D	105	4.1339	290	11.4173	130	5.1181	3.0	.12	1.0	.040	540 000	121 000	670 000	151 000	1 800	2 400
7422-D	110	4.3307	320	12.5984	140	5.5118	3.0	.12	1.0	.040	605 000	136 000	800 000	180 000	1 700	2 300

¹⁾ Fillet radius indicates maximum fillet radius on shaft or in housing which bearing corner will clear.

²⁾ For thrust rating multiply C_r by 1.32 and C₀ by 2.94 (single) and C_r by .81 and C₀ by 1.47 (duplex).

³⁾ Listed values are for machined bronze cage, ABEC-1.

For phenolic composition cage, multiply by 1.33 for both grease and oil. For phenolic composition cage, ABEC-5 or 7, multiply by 1.86 for both grease and oil. For pressed steel cage, ABEC-1, multiply by 0.67 for grease and 0.80 for oil. The speed rating adjustment factors have been determined through historical application and practice. For a more complete explanation, see page 276.

⁴⁾ Rating for one million revolutions or 500 hours at 33 1/3 RPM.

7000 Series
29 Degree Angular
Contact Ball Bearings
Single Bearing

Dynamic and static equivalent radial load
and life rating

Dynamic equivalent radial load

$$P = F_R \quad \text{when } F_A/F_R \leq 0.80$$

or

$$P = 0.39 F_R + 0.76 F_A \quad \text{when } F_A/F_R > 0.80$$

P = Dynamic equivalent radial load
F_R = Radial load
F_A = Thrust load

Static equivalent radial load

$$P_0 = 0.50 F_R + 0.34 F_A$$

P₀ is always $\geq F_R$

P₀ = Static equivalent radial load
F_R = Radial load
F_A = Thrust load

Life rating

$$L_{10} = \left(\frac{C}{P}\right)^3 \quad (\text{millions of revolutions})$$

or

$$L_{10h} = \frac{10^6}{60n} \left(\frac{C}{P}\right)^3 \quad (\text{Hours})$$

C = Basic dynamic radial load rating
(from single bearing tables)
P = Dynamic equivalent radial load
n = Speed in rpm

7000 Series 29 Degree Angular Contact Ball Bearings Single Bearing

Dynamic equivalent radial load and life calculation examples

Bearing size: 7309

Speed: 2000 RPM

Basic dynamic radial load rating (C) = 11800

Case 1

Radial load (F_R) = 1750

Thrust load (F_A) = 1310

Equivalent load (P) = F_R or $0.39 F_R + 0.76 F_A$

$F_A/F_R = 1310/1750 = 0.75$

Since $F_A/F_R < 0.80$, $P = F_R = 1750$

$$\text{Life (L}_{10}\text{)} = \left(\frac{C}{P}\right)^3 = \left(\frac{11800}{1750}\right)^3 = 307 \times 10^6 \text{ Rev.}$$

or

$$\begin{aligned} \text{Life (L}_{10}\text{h)} &= \frac{10^6}{60n} \left(\frac{C}{P}\right)^3 = \frac{10^6}{60 \times 2000} \left(\frac{11800}{1750}\right)^3 \\ &= 2558 \text{ Hrs} \end{aligned}$$

Case 2

Radial load (F_R) = 1750

Thrust load (F_A) = 2100

Equivalent load (P) = F_R or $0.39 F_R + 0.76 F_A$

$F_A/F_R = 2100/1750 = 1.20$

Since $F_A/F_R > 0.80$, $P = 0.39 \times 1750 + 0.76 \times 2100 = 2279$

$$\text{Life (L}_{10}\text{)} = \left(\frac{C}{P}\right)^3 = \left(\frac{11800}{2279}\right)^3 = 139 \times 10^6 \text{ Rev.}$$

or

$$\begin{aligned} \text{Life (L}_{10}\text{h)} &= \frac{10^6}{60n} \left(\frac{C}{P}\right)^3 = \frac{10^6}{60 \times 2000} \left(\frac{11800}{2279}\right)^3 \\ &= 1158 \text{ Hrs} \end{aligned}$$

Case 3

Thrust load (F_A) = 2100

Equivalent load (P) = $0.39 F_R + 0.76 F_A$

$F_A/F_R = 2100/0 = \infty$

Since $F_A/F_R > 0.80$, $P = 0.76 \times 2100 = 1596$

$$\text{Life (L}_{10}\text{)} = \left(\frac{C}{P}\right)^3 = \left(\frac{11800}{1596}\right)^3 = 404 \times 10^6 \text{ Rev.}$$

or

$$\begin{aligned} \text{Life (L}_{10}\text{h)} &= \frac{10^6}{60n} \left(\frac{C}{P}\right)^3 = \frac{10^6}{60 \times 2000} \left(\frac{11800}{1596}\right)^3 \\ &= 3367 \text{ Hrs} \end{aligned}$$

***Duplex 7000-D Series
29 Degree Angular Contact
Ball Bearings***

***Dynamic and static equivalent radial load
and life rating***

Dynamic equivalent radial load

DB or DF pair
 $P = 1.0 F_R + 0.78 F_A$ when $\frac{F_A}{F_R} \leq 0.80$

$P = 0.63 F_R + 1.24 F_A$ when $\frac{F_A}{F_R} > 0.80$

Tandem DT
 $P = 1.0 F_R$ when $\frac{F_A}{F_R} \leq 0.80$

$P = 0.39 F_R + 0.76 F_A$ when $\frac{F_A}{F_R} > 0.80$

P = Dynamic equivalent radial load

F_R = Radial load

F_A = Thrust load

Life rating

$L_{10} = \left(\frac{C}{P}\right)^3$ (millions of revolutions)

or

$L_{10h} = \frac{10^6 (C/P)^3}{60n}$ (Hours)

For DB or DF mounting:

C = Duplex dynamic radial load
 Rating (from duplex bearing tables)

or

C = Single-row dynamic radial load
 Rating times $(i)^{0.7}$, where $i = 2$

For tandem mounting:

C = Single-row dynamic radial load
 Rating times $(i)^{0.7}$, where

i = Number of bearings in set

P = Dynamic equivalent radial load

n = Speed in rpm

Static equivalent radial load

$P_0 = 1.0 F_R + 0.66 F_A$

P_0 is always $\geq F_R$

P_0 = Static equivalent radial load

F_R = Radial load

F_A = Thrust load

Duplex 7000-D Series 29 Degree Angular Contact Ball Bearings

Dynamic equivalent radial load and life calculation examples

Bearing size: 7309DU (DB or DF Pair)
Speed: 2000 RPM
Duplex pair basic dynamic radial load
Rating (C) = 19200

Bearing size: 7309DT
3 bearings in tandem
Speed: 2000 RPM
Single-row basic dynamic radial load
Rating (C) = 11800

Case 1

Radial load (F_R) = 1750
Thrust load (F_A) = 1310
 $F_A/F_R = 1310/1750 = 0.75$
Since $F_A/F_R < 0.80$, equivalent load (P) =
 $1.0 F_R + 0.78 F_A$
 $= 1.0 \times 1750 + 0.78 \times 1310 = 2772$

$$\text{Life (L}_{10}) = \left(\frac{C}{P}\right)^3 = \left(\frac{19200}{2772}\right)^3 = 332 \times 10^6 \text{ Rev.}$$

or

$$\text{Life (L}_{10\text{h})} = \frac{10^6}{60n} \left(\frac{C}{P}\right)^3 = \frac{10^6}{60 \times 2000} \left(\frac{19200}{2772}\right)^3$$

$$= 2767 \text{ Hrs}$$

Case 2

Radial load (F_R) = 1750
Thrust load (F_A) = 2100
 $F_A/F_R = 2100/1750 = 1.20$
Since $F_A/F_R > 0.80$, equivalent load (P) =
 $0.63 F_R + 1.24 F_A$
 $= 0.63 \times 1750 + 1.24 \times 2100 = 3707$

$$\text{Life (L}_{10}) = \left(\frac{C}{P}\right)^3 = \left(\frac{19200}{3707}\right)^3 = 139 \times 10^6 \text{ Rev.}$$

or

$$\text{Life (L}_{10\text{h})} = \frac{10^6}{60n} \left(\frac{C}{P}\right)^3 = \frac{10^6}{60 \times 2000} \left(\frac{19200}{3707}\right)^3$$

$$= 1158 \text{ Hrs}$$

Case 3

Thrust load (F_A) = 2100
 $F_A/F_R = 2100/0 = \infty$
Since $F_A/F_R > 0.80$, equivalent load (P) =
 $0.63 F_R + 1.24 F_A = 1.24 \times 2100 = 2604$

$$\text{Life (L}_{10}) = \left(\frac{C}{P}\right)^3 = \left(\frac{19200}{2604}\right)^3 = 401 \times 10^6 \text{ Rev.}$$

or

$$\text{Life (L}_{10\text{h})} = \frac{10^6}{60n} \left(\frac{C}{P}\right)^3 = \frac{10^6}{60 \times 2000} \left(\frac{19200}{2604}\right)^3$$

$$= 3342 \text{ Hrs}$$

Case 1

Thrust load (F_A) = 4200
 $F_A/F_R = 4200/0 = \infty$
Since $F_A/F_R > 0.80$, equivalent load (P) =
 $0.39 F_R + 0.76 F_A = 0.76 \times 4200 = 3192$
Load rating = (i)^{0.7} × 11800
 $= (3)^{0.7} \times 11800 = 25460$

$$\text{Life (L}_{10}) = \left(\frac{C}{P}\right)^3 = \left(\frac{25460}{3192}\right)^3 = 507 \times 10^6 \text{ Rev.}$$

or

$$\text{Life (L}_{10\text{h})} = \frac{10^6}{60n} \left(\frac{C}{P}\right)^3 = \frac{10^6}{60 \times 2000} \left(\frac{25460}{3192}\right)^3$$

$$= 4225 \text{ Hrs}$$

Case 2

Radial load (F_R) = 3500
Thrust load (F_A) = 4200
 $F_A/F_R = 4200/3500 = 1.20$
Since $F_A/F_R > 0.80$, equivalent load (P) =
 $0.39 F_R + 0.76 F_A$
 $= 0.39 \times 3500 + 0.76 \times 4200 = 4557$
Load rating = (i)^{0.7} × 11800
 $= (3)^{0.7} \times 11800 = 25460$

$$\text{Life (L}_{10}) = \left(\frac{C}{P}\right)^3 = \left(\frac{25460}{4557}\right)^3 = 174 \times 10^6 \text{ Rev.}$$

or

$$\text{Life (L}_{10\text{h})} = \frac{10^6}{60n} \left(\frac{C}{P}\right)^3 = \frac{10^6}{60 \times 2000} \left(\frac{25460}{4557}\right)^3$$

$$= 1450 \text{ Hrs}$$

NOTES

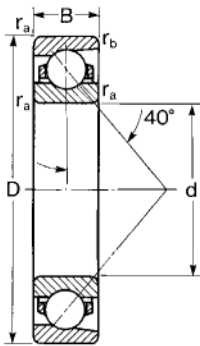

MRC 7000-P Series bearings are similar in design to 7000 Series bearings, but the 7000-P Series bearings have features that give them a greatly increased thrust capacity. They are especially recommended for those applications where maximum thrust capacity is required.

This heavy-duty angular contact bearing series is designed with an optimum ball complement and race groove depth and have a 40 degree contact angle.

7000-P bearings are restricted to applications involving primarily thrust loads. They should **not** be used where the bearing will be subjected to radial load exclusively, or combined radial and thrust load where the radial load is predominant.

Cage Types and Materials

Furnished in one-piece machined bronze, phenolic composition or special material riding ground O.D. of inner ring.

Size	Series	Page
7200P	Light—Single Bearing	98
7200PD	Light—Duplex Set	99
7300P	Medium—Single Bearing	100
7300PD	Medium—Duplex Set	101
7400P/PD	Heavy—Single and Duplex Set	102
7000P	Equivalent Load and Life	104
7000P	Life Calculation Examples	105
7000PD	Equivalent Load and Life	106
7000PD	Life Calculation Examples	107

7200-P Light Series (Single Bearings)

MRC Bearing Services

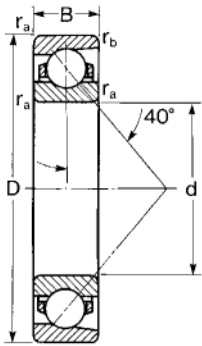

7200-P Light Series bearings are available in bore sizes ranging from 10 mm to 200 mm. They are used with heavy one-directional thrust loads, or combined radial and thrust loads where the thrust load is predominant.

Caution: Single bearings are not to be used where only radial loads are present. For two-direction thrust loads, use duplex bearings.

MRC Bearing Number	Bore		Outside Diameter D		Width B		Fillet Radius ¹⁾				Basic Radial Load Rating ²⁾				Speed Rating ³⁾	
											Dynamic C ⁴⁾		Static C ₀		Grease	Oil
	d	mm	in	mm	in	mm	in	mm	in	mm	in	N	lbf	N	lbf	RPM
7200-P	10	.3937	30	1.1811	9	.3543	.64	.025	.30	.012	7 020	1 580	3 200	719	19 000	28 000
7201-P	12	.4724	32	1.2598	10	.3937	.64	.025	.30	.012	7 610	1 710	3 750	843	18 000	26 000
7202-P	15	.5906	35	1.3780	11	.4331	.64	.025	.30	.012	8 840	1 990	4 250	955	17 000	24 000
7203-P	17	.6693	40	1.5748	12	.4724	.64	.025	.30	.012	11 700	2 630	6 000	1 350	15 000	20 000
7204-P	20	.7874	47	1.8504	14	.5512	1.0	.04	.60	.024	14 800	3 330	8 300	1 870	12 000	17 000
7205-P	25	.9843	52	2.0472	15	.5906	1.0	.04	.60	.024	16 800	3 780	10 400	2 340	10 000	15 000
7206-P	30	1.1811	62	2.4409	16	.6299	1.0	.04	.60	.024	21 200	4 770	12 700	2 860	8 500	12 000
7207-P	35	1.3780	72	2.8346	17	.6693	1.0	.04	.60	.024	29 100	6 540	19 300	4 340	8 000	11 000
7208-P	40	1.5748	80	3.1496	18	.7087	1.0	.04	.60	.024	32 500	7 310	22 400	5 040	7 000	9 500
7209-P	45	1.7717	85	3.3465	19	.7480	1.0	.04	.60	.024	39 000	8 770	27 500	6 180	6 700	9 000
7210-P	50	1.9685	90	3.5433	20	.7874	1.0	.04	.60	.024	40 300	9 060	30 000	6 740	6 000	8 000
7211-P	55	2.1654	100	3.9370	21	.8268	1.5	.06	1.0	.040	48 800	11 000	37 500	8 430	5 600	7 500
7212-P	60	2.3622	110	4.3307	22	.8661	1.5	.06	1.0	.040	58 500	13 200	45 500	10 200	5 000	6 700
7213-P	65	2.5591	120	4.7244	23	.9055	1.5	.06	1.0	.040	63 700	14 300	51 000	11 500	4 500	6 000
7214-P	70	2.7559	125	4.9213	24	.9449	1.5	.06	1.0	.040	68 900	15 500	56 000	12 600	4 300	5 600
7215-P	75	2.9528	130	5.1181	25	.9843	1.5	.06	1.0	.040	71 500	16 100	60 000	13 500	4 000	5 300
7216-P	80	3.1496	140	5.5118	26	1.0236	2.0	.08	1.0	.040	83 200	18 700	71 000	16 000	3 800	5 000
7217-P	85	3.3465	150	5.9055	28	1.1024	2.0	.08	1.0	.040	95 600	21 500	83 000	18 700	3 600	4 800
7218-P	90	3.5433	160	6.2992	30	1.1811	2.0	.08	1.0	.040	108 000	24 300	95 000	21 400	3 400	4 500
7219-P	95	3.7402	170	6.6929	32	1.2598	2.0	.08	1.0	.040	124 000	27 900	110 000	24 700	3 200	4 300
7220-P	100	3.9370	180	7.0866	34	1.3386	2.0	.08	1.0	.040	130 000	29 200	125 000	28 100	3 000	4 000
7221-P	105	4.1339	190	7.4803	36	1.4173	2.0	.08	1.0	.040	143 000	32 100	129 000	29 000	2 800	3 800
7222-P	110	4.3307	200	7.8740	38	1.4961	2.0	.08	1.0	.040	153 000	34 400	156 000	35 100	2 600	3 600
7224-P	120	4.7244	215	8.4646	40	1.5748	2.0	.08	1.0	.040	165 000	37 100	163 000	36 600	2 200	3 200
7226-P	130	5.1181	230	9.0551	40	1.5748	2.5	.10	1.0	.040	186 000	41 800	193 000	43 400	1 900	2 800
7228-P	140	5.5118	250	9.8425	42	1.6535	2.5	.10	1.0	.040	199 000	44 700	216 000	48 600	1 800	2 600
7230-P	150	5.9055	270	10.6299	45	1.7717	2.5	.10	1.0	.040	216 000	48 600	260 000	58 500	1 700	2 400
7232-P	160	6.2992	290	11.4173	48	1.8898	2.5	.10	1.0	.040	238 000	53 500	280 000	62 900	1 600	2 200
7234-P	170	6.6929	310	12.2047	52	2.0472	3.0	.12	1.0	.040	265 000	59 600	335 000	75 300	1 600	2 200
7236-P	180	7.0866	320	12.5984	52	2.0472	3.0	.12	1.0	.040	276 000	62 000	355 000	79 800	1 500	2 000
7238-P	190	7.4803	340	13.3858	55	2.1654	3.0	.12	1.0	.040	302 000	67 900	405 000	91 000	1 400	1 900
7240-P	200	7.8740	360	14.1732	58	2.2835	3.0	.12	1.0	.040	319 000	71 700	440 000	98 900	1 300	1 800

¹⁾ Fillet radius indicates maximum fillet radius on shaft or in housing which bearing corner will clear.

²⁾ For thrust rating multiply C by 1.75 and C₀ by 3.85.

³⁾ Listed values are for machined bronze cage, ABEC-1.

For phenolic composition cage, multiply by 1.33 for both grease and oil. For phenolic composition cage, ABEC-5 or 7, multiply by 1.86 for both grease and oil. For pressed steel cage, ABEC-1, multiply by 0.67 for grease and 0.80 for oil. The speed rating adjustment factors have been determined through historical application and practice. For a more complete explanation, see page 276

⁴⁾ Rating for one million revolutions or 500 hours at 33 1/3 RPM.

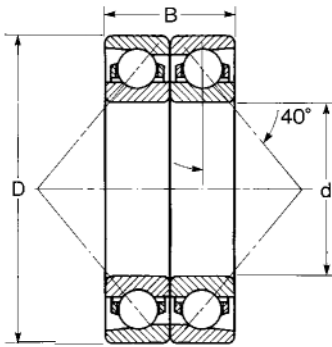

"D" indicates a duplex ground half pair matched with an identical half pair and is followed by an additional suffix letter to describe the type of duplex. See pages 236 and 237 for suffix description.

For duplex sets of 7000 and 9000 series bearings see page 239

Note: ABEC - 1 & 3 stocked as half-pairs, where available.

Use these values for back-to-back (DB) or face-to-face (DF) mounting arrangements.

MRC Bearing Number	Bore		Outside Diameter D		Width B		Fillet Radius ¹⁾				Basic Radial Load Rating ²⁾				Speed Rating ³⁾	
	d mm	in	mm	in	mm	in	r _a mm	in	r _b mm	in	Dynamic C _d ⁴⁾		Static C ₀		Grease RPM	Oil RPM
											N	lbf	N	lbf		
7200-PD	10	.3937	30	1.1811	18	.7087	.64	.025	.30	.012	11 400	2 560	6 400	1 440	16 000	22 000
7201-PD	12	.4724	32	1.2598	20	.7874	.64	.025	.30	.012	12 500	2 810	7 500	1 690	13 000	18 000
7202-PD	15	.5906	35	1.3780	22	.8661	.64	.025	.30	.012	14 300	3 210	8 500	1 910	12 000	17 000
7203-PD	17	.6693	40	1.5748	24	.9449	.64	.025	.30	.012	19 000	4 270	12 000	2 700	11 000	16 000
7204-PD	20	.7874	47	1.8504	28	1.1024	1.0	.04	.60	.024	24 200	5 440	16 600	3 730	9 500	14 000
7205-PD	25	.9843	52	2.0472	30	1.1811	1.0	.04	.60	.024	27 000	6 070	20 800	4 680	8 500	12 000
7206-PD	30	1.1811	62	2.4409	32	1.2598	1.0	.04	.60	.024	34 500	7 760	25 500	5 730	7 500	10 000
7207-PD	35	1.3780	72	2.8346	34	1.3386	1.0	.04	.60	.024	47 500	10 700	39 000	8 770	6 300	8 500
7208-PD	40	1.5748	80	3.1496	36	1.4173	1.0	.04	.60	.024	52 700	11 800	45 000	10 100	5 600	7 500
7209-PD	45	1.7717	85	3.3465	38	1.4961	1.0	.04	.60	.024	62 400	14 000	55 000	12 400	5 300	7 000
7210-PD	50	1.9685	90	3.5433	40	1.5748	1.0	.04	.60	.024	65 000	14 600	60 000	13 500	4 800	6 300
7211-PD	55	2.1654	100	3.9370	42	1.6535	1.5	.06	1.0	.040	79 300	17 800	75 000	16 900	4 500	6 000
7212-PD	60	2.3622	110	4.3307	44	1.7323	1.5	.06	1.0	.040	95 600	21 500	91 600	20 600	4 000	5 300
7213-PD	65	2.5591	120	4.7244	46	1.8110	1.5	.06	1.0	.040	104 000	23 400	100 000	22 500	3 600	4 800
7214-PD	70	2.7559	125	4.9213	48	1.8898	1.5	.06	1.0	.040	112 000	25 200	112 000	25 200	3 400	4 500
7215-PD	75	2.9528	130	5.1181	50	1.9685	1.5	.06	1.0	.040	117 000	26 300	120 000	27 000	3 200	4 300
7216-PD	80	3.1496	140	5.5118	52	2.0472	2.0	.08	1.0	.040	135 000	30 300	140 000	31 500	3 000	4 000
7217-PD	85	3.3465	150	5.9055	56	2.2047	2.0	.08	1.0	.040	156 000	35 100	166 000	37 300	2 800	3 800
7218-PD	90	3.5433	160	6.2992	60	2.3622	2.0	.08	1.0	.040	178 000	40 000	190 000	42 700	2 600	3 600
7219-PD	95	3.7402	170	6.6929	64	2.5197	2.0	.08	1.0	.040	199 000	44 700	220 000	49 500	2 400	3 400
7220-PD	100	3.9370	180	7.0866	68	2.6772	2.0	.08	1.0	.040	212 000	47 700	250 000	56 200	2 200	3 200
7221-PD	105	4.1339	190	7.4803	72	2.8346	2.0	.08	1.0	.040	229 000	51 500	260 000	58 500	2 000	3 000
7222-PD	110	4.3307	200	7.8740	76	2.9921	2.0	.08	1.0	.040	251 000	56 400	310 000	69 700	1 900	2 800
7224-PD	120	4.7244	215	8.4646	80	3.1496	2.0	.08	1.0	.040	270 000	60 700	325 000	73 100	1 700	2 400
7226-PD	130	5.1181	230	9.0551	80	3.1496	2.5	.10	1.0	.040	302 000	67 900	390 000	87 700	1 700	2 400
7228-PD	140	5.5118	250	9.8425	84	3.3071	2.5	.10	1.0	.040	319 000	71 700	430 000	96 700	1 600	2 200
7230-PD	150	5.9055	270	10.6299	90	3.5433	2.5	.10	1.0	.040	351 000	78 900	520 000	117 000	1 500	2 000
7232-PD	160	6.2992	290	11.4173	96	3.7795	2.5	.10	1.0	.040	390 000	87 700	560 000	126 000	1 300	1 700
7234-PD	170	6.6929	310	12.2047	104	4.0945	3.0	.12	1.0	.040	436 000	98 000	655 000	147 000	1 200	1 600
7236-PD	180	7.0866	320	12.5984	104	4.0945	3.0	.12	1.0	.040	449 000	101 000	710 000	160 000	1 100	1 500
7238-PD	190	7.4803	340	13.3858	110	4.3307	3.0	.12	1.0	.040	488 000	110 000	815 000	183 000	1 100	1 500
7240-PD	200	7.8740	360	14.1732	116	4.5669	3.0	.12	1.0	.040	520 000	117 000	880 000	198 000	1 000	1 400

¹⁾ Fillet radius indicates maximum fillet radius on shaft or in housing which bearing corner will clear.

²⁾ For thrust rating multiply C by 1.08 and C₀ by 1.93.

³⁾ Listed values are for machined bronze cage, ABEC-1.

For phenolic composition cage, multiply by 1.33 for both grease and oil. For phenolic composition cage, ABEC-5 or 7, multiply by 1.86 for both grease and oil. For pressed steel cage, ABEC-1, multiply by 0.67 for grease and 0.80 for oil. The speed rating adjustment factors have been determined through historical application and practice. For a more complete explanation, see page 276

⁴⁾ Rating for one million revolutions or 500 hours at 33 1/3 RPM.

7300-P Medium Series (Single Bearings)

MRC Bearing Services

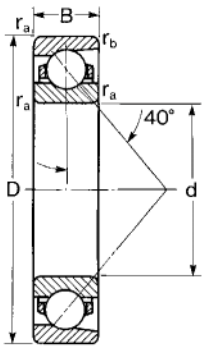

7300-P Medium Series bearings are available in bore sizes from 10 mm to 200 mm. They can accommodate very heavy one-directional thrust loads, or combined radial and thrust loads where the thrust load is predominant.

Caution: Single bearings are not to be used where only radial loads are present. For two-direction thrust loads, use duplex bearings.

MRC Bearing Number	Bore		Outside Diameter D		Width B		Fillet Radius ¹⁾				Basic Radial Load Rating ²⁾				Speed Rating ³⁾	
											Dynamic C _d		Static C ₀		Grease RPM	Oil RPM
	d mm	in	mm	in	mm	in	mm	in	mm	in	N	lbf	N	lbf		
7300-P	10	.3937	35	1.3780	11	.4331	.64	.025	.30	.012	9 360	2 100	4 150	933	18 000	26 000
7301-P	12	.4724	37	1.4567	12	.4724	1.0	.04	.60	.024	11 200	2 520	5 000	1 120	17 000	24 000
7302-P	15	.5906	42	1.6535	13	.5118	1.0	.04	.60	.024	12 700	2 860	6 100	1 370	15 000	20 000
7303-P	17	.6693	47	1.8504	14	.5512	1.0	.04	.60	.024	16 800	3 780	8 500	1 910	13 000	18 000
7304-P	20	.7874	52	2.0472	15	.5906	1.0	.04	.60	.024	18 600	4 180	9 500	2 140	11 000	16 000
7305-P	25	.9843	62	2.4409	17	.6693	1.0	.04	.60	.024	24 200	5 440	13 400	3 010	9 000	13 000
7306-P	30	1.1811	72	2.8346	19	.7480	1.0	.04	.60	.024	32 500	7 310	19 600	4 410	8 000	11 000
7307-P	35	1.3780	80	3.1496	21	.8268	1.5	.06	1.0	.040	39 700	8 920	24 500	5 510	7 500	10 000
7308-P	40	1.5748	90	3.5433	23	.9055	1.5	.06	1.0	.040	47 500	10 700	30 500	6 860	6 700	9 000
7309-P	45	1.7717	100	3.9370	25	.9843	1.5	.06	1.0	.040	59 200	13 300	40 000	8 990	6 000	8 000
7310-P	50	1.9685	110	4.3307	27	1.0630	2.0	.08	1.0	.040	68 900	15 500	52 000	11 700	5 300	7 000
7311-P	55	2.1654	120	4.7244	29	1.1417	2.0	.08	1.0	.040	79 300	17 800	56 000	12 600	4 800	6 300
7312-P	60	2.3622	130	5.1181	31	1.2205	2.0	.08	1.0	.040	90 400	20 300	64 000	13 500	4 500	6 000
7313-P	65	2.5591	140	5.5118	33	1.2992	2.0	.08	1.0	.040	101 000	22 700	80 000	18 000	4 300	5 600
7314-P	70	2.7559	150	5.9055	35	1.3780	2.0	.08	1.0	.040	117 000	26 300	93 000	20 900	3 800	5 000
7315-P	75	2.9528	160	6.2992	37	1.4567	2.0	.08	1.0	.040	127 000	28 600	100 000	22 500	3 600	4 800
7316-P	80	3.1496	170	6.6929	39	1.5354	2.0	.08	1.0	.040	138 000	31 000	110 000	24 700	3 400	4 500
7317-P	85	3.3465	180	7.0866	41	1.6142	2.5	.10	1.0	.040	148 000	33 300	122 000	27 400	3 200	4 300
7318-P	90	3.5433	190	7.4803	43	1.6299	2.5	.10	1.0	.040	159 000	35 700	137 000	30 800	3 000	4 000
7319-P	95	3.7402	200	7.8740	45	1.7717	2.5	.10	1.0	.040	168 000	37 800	150 000	33 700	2 800	3 800
7320-P	100	3.9370	215	8.4646	47	1.8504	2.5	.10	1.0	.040	190 000	42 700	190 000	42 700	2 600	3 600
7321-P	105	4.1339	225	8.8583	49	1.9291	2.5	.10	1.0	.040	203 000	45 600	196 000	44 100	2 400	3 400
7322-P	110	4.3307	240	9.4488	50	1.9685	2.5	.10	1.0	.040	212 000	47 700	228 000	51 300	2 200	3 200
7324-P	120	4.7244	260	10.2362	55	2.1654	2.5	.10	1.0	.040	238 000	53 500	265 000	59 600	1 900	2 800
7326-P	130	5.1181	280	11.0236	58	2.2835	3.0	.12	1.0	.040	276 000	62 000	305 000	68 600	1 800	2 600
7328-P	140	5.5118	300	11.8110	62	2.4409	3.0	.12	1.0	.040	302 000	67 900	345 000	77 600	1 700	2 400
7330-P	150	5.9055	320	12.5984	65	2.5591	3.0	.12	1.0	.040	325 000	73 100	390 000	87 700	1 600	2 200
7332-P	160	6.2992	340	13.3858	68	2.6772	3.0	.12	1.0	.040	345 000	77 600	425 000	95 500	1 500	2 000
7334-P	170	6.6929	360	14.1732	72	2.8346	3.0	.12	1.0	.040	377 000	84 800	490 000	110 000	1 400	1 900
7336-P	180	7.0866	380	14.9606	75	2.9528	3.0	.12	1.0	.040	403 000	90 600	540 000	121 000	1 300	1 800
7338-P	190	7.4803	400	15.7480	78	3.0709	4.0	.16	1.5	.060	416 000	93 500	570 000	128 000	1 200	1 700
7340-P	200	7.8740	420	16.5354	80	3.1496	4.0	.16	1.5	.060	449 000	101 000	655 000	147 000	1 100	1 600

¹⁾ Fillet radius indicates maximum fillet radius on shaft or in housing which bearing corner will clear.

²⁾ For thrust rating multiply C by 1.75 and C₀ by 3.85.

³⁾ Listed values are for machined bronze cage, ABEC-1.

For phenolic composition cage, multiply by 1.33 for both grease and oil. For phenolic composition cage, ABEC-5 or 7, multiply by 1.86 for both grease and oil. For pressed steel cage, ABEC-1, multiply by 0.67 for grease and 0.80 for oil. The speed rating adjustment factors have been determined through historical application and practice. For a more complete explanation, see page 276

⁴⁾ Rating for one million revolutions or 500 hours at 33 1/3 RPM.

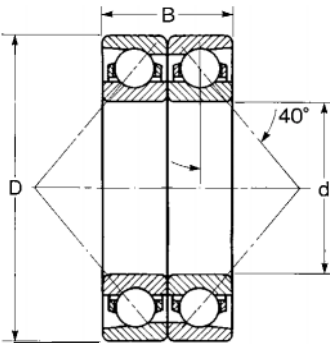

Note: ABEC-1 & 3 stocked as half-pairs, where available.

"D" indicates a duplex ground half pair matched with an identical half pair and is followed by an additional suffix letter to describe the type of duplex. See pages 236 and 237 for suffix description.

For duplex sets of 7000 and 9000 series bearings see page 239

Use these values for back-to-back (DB) or face-to-face (DF) mounting arrangements.

MRC Bearing Number	Bore		Outside Diameter D		Width B		Fillet Radius ¹⁾				Basic Radial Load Rating ²⁾				Speed Rating ³⁾	
											Dynamic C _d ⁴⁾		Static C ₀		Grease	Oil
	d	mm	in	mm	in	mm	in	r _a	r _b	mm	in	N	lbf	N	lbf	RPM
7300-PD	10	.3937	35	1.3780	22	.8661	.64	.025	.30	.012	15 300	3 440	8 300	1 870	15 000	21 000
7301-PD	12	.4724	37	1.4567	24	.9449	1.0	.04	.60	.024	18 200	4 090	10 200	2 290	14 000	19 000
7302-PD	15	.5906	42	1.6535	26	1.0236	1.0	.04	.60	.024	20 300	4 560	12 200	2 740	11 000	16 000
7303-PD	17	.6693	47	1.8504	28	1.1024	1.0	.04	.60	.024	27 600	6 200	17 000	3 820	9 500	14 000
7304-PD	20	.7874	52	2.0472	30	1.1811	1.0	.04	.60	.024	30 200	6 790	19 000	4 270	9 000	13 000
7305-PD	25	.9843	62	2.4409	34	1.3386	1.0	.04	.60	.024	39 000	8 770	27 000	6 070	7 500	10 000
7306-PD	30	1.1811	72	2.8346	38	1.4961	1.0	.04	.60	.024	52 700	11 800	39 000	8 770	6 700	9 000
7307-PD	35	1.3780	80	3.1496	42	1.6535	1.5	.06	1.0	.040	63 700	14 300	49 000	11 000	6 000	8 000
7308-PD	40	1.5748	90	3.5433	46	1.8110	1.5	.06	1.0	.040	76 100	17 100	61 000	13 700	5 300	7 000
7309-PD	45	1.7717	100	3.9370	50	1.9685	1.5	.06	1.0	.040	97 500	21 900	80 000	18 000	4 800	6 300
7310-PD	50	1.9685	110	4.3307	54	2.1260	2.0	.08	1.0	.040	112 000	25 200	104 000	23 400	4 300	5 600
7311-PD	55	2.1654	120	4.7244	58	2.2835	2.0	.08	1.0	.040	130 000	29 200	112 000	25 200	3 800	5 000
7312-PD	60	2.3622	130	5.1181	62	2.4409	2.0	.08	1.0	.040	148 000	33 300	129 000	29 000	3 600	4 800
7313-PD	65	2.5591	140	5.5118	66	2.5984	2.0	.08	1.0	.040	165 000	37 100	160 000	36 000	3 200	4 300
7314-PD	70	2.7559	150	5.9055	70	2.7559	2.0	.08	1.0	.040	190 000	42 700	186 000	41 800	3 000	4 000
7315-PD	75	2.9528	160	6.2992	74	2.9134	2.0	.08	1.0	.040	208 000	46 800	200 000	45 000	2 800	3 800
7316-PD	80	3.1496	170	6.6929	78	3.0709	2.0	.08	1.0	.040	225 000	50 600	220 000	49 500	2 600	3 600
7317-PD	85	3.3465	180	7.0866	82	3.2283	2.5	.10	1.0	.040	238 000	53 500	245 000	55 100	2 400	3 400
7318-PD	90	3.5433	190	7.4803	86	3.3858	2.5	.10	1.0	.040	255 000	57 300	270 000	60 700	2 200	3 200
7319-PD	95	3.7402	200	7.8740	90	3.5433	2.5	.10	1.0	.040	276 000	62 000	300 000	67 400	2 000	3 000
7320-PD	100	3.9370	215	8.4646	94	3.7008	2.5	.10	1.0	.040	307 000	69 000	380 000	85 400	1 900	2 800
7321-PD	105	4.1339	225	8.8583	98	3.8583	2.5	.10	1.0	.040	325 000	73 100	390 000	87 700	1 800	2 600
7322-PD	110	4.3307	240	9.4488	100	3.9370	2.5	.10	1.0	.040	345 000	77 600	455 000	102 000	1 700	2 400
7324-PD	120	4.7244	260	10.2362	110	4.3307	2.5	.10	1.0	.040	390 000	87 700	530 000	119 000	1 600	2 200
7326-PD	130	5.1181	280	11.0236	116	4.5669	3.0	.12	1.0	.040	449 000	101 000	610 000	137 000	1 500	2 000
7328-PD	140	5.5118	300	11.8110	124	4.8319	3.0	.12	1.0	.040	488 000	110 000	695 000	156 000	1 400	1 900
7330-PD	150	5.9055	320	12.5984	130	5.1181	3.0	.12	1.0	.040	540 000	121 000	780 000	175 000	1 200	1 700
7332-PD	160	6.2992	340	13.3858	136	5.3543	3.0	.12	1.0	.040	553 000	124 000	850 000	191 000	1 200	1 600
7334-PD	170	6.6929	360	14.1732	144	5.6693	3.0	.12	1.0	.040	605 000	136 000	965 000	217 000	1 000	1 500
7336-PD	180	7.0866	380	14.9606	150	5.9055	3.0	.12	1.0	.040	650 000	146 000	1 100 000	247 000	950	1 400
7338-PD	190	7.4803	400	15.7480	156	6.1417	4.0	.16	1.5	.060	676 000	152 000	1 160 000	261 000	950	1 400
7340-PD	200	7.8740	420	16.5354	160	6.2992	4.0	.16	1.5	.060	741 000	167 000	1 320 000	297 000	880	1 300

¹⁾ Fillet radius indicates maximum fillet radius on shaft or in housing which bearing corner will clear.

²⁾ For thrust rating multiply C by 1.08 and C₀ by 1.93.

³⁾ Listed values are for machined bronze cage, ABEC-1.

For phenolic composition cage, multiply by 1.33 for both grease and oil. For phenolic composition cage, ABEC-5 or 7, multiply by 1.86 for both grease and oil. For pressed steel cage, ABEC-1, multiply by 0.67 for grease and 0.80 for oil. The speed rating adjustment factors have been determined through historical application and practice. For a more complete explanation, see page 276

⁴⁾ Rating for one million revolutions or 500 hours at 33 1/3 RPM.

7400-P Heavy Series

7400-PD Heavy Series Duplex

MRC Bearing Services

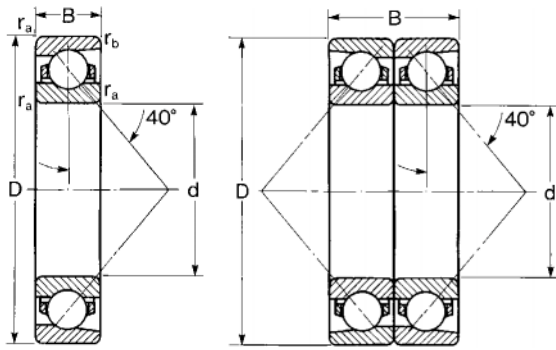

7400-P Series bearings are similar to the 7200-P and 7300-P Series but are heavier sectioned and are used for very heavy thrust loads or combined radial and thrust loads where thrust is predominant.

"D" indicates a duplex ground half pair matched with an identical half pair and is followed by an additional suffix letter to describe the type of duplex. See pages 236 and 237 for suffix description.

For duplex sets of 7000 and 9000 series bearings see page 239

Caution: Single bearings are not to be used where only radial loads are present. For two-direction thrust loads, use duplex bearings.

Values for -D bearings are for back-to-back (DB) or face-to-face (DF) mounting arrangements.

MRC Bearing Number	Bore		Outside Diameter D		Width B		Fillet Radius ¹⁾				Basic Radial Load Rating ²⁾				Speed Rating ³⁾	
											Dynamic C _d ⁴⁾		Static C ₀		Grease RPM	Oil RPM
											N	lbf	N	lbf		
7405P	25	.9843	80	3.1496	21	.8268	1.5	.060	1.0	.040	39 700	8 920	28 600	5 310	7 000	10 000
7406P	30	1.1811	90	3.5433	23	.9055	1.5	.060	1.0	.040	47 500	10 700	29 000	6 520	6 300	9 000
7407P	35	1.3780	100	3.9370	25	.9843	1.5	.060	1.0	.040	60 500	13 600	38 000	8 540	5 600	7 500
7408P	40	1.5748	110	4.3307	27	1.0630	2.0	.080	1.0	.040	70 200	15 800	45 000	10 100	5 300	7 000
7409P	45	1.7717	120	4.7244	29	1.1417	2.0	.080	1.0	.040	85 200	19 200	55 000	12 400	4 800	6 300
7410P	50	1.9685	130	5.1181	31	1.2205	2.0	.080	1.0	.040	95 600	21 500	64 000	14 400	4 300	6 000
7411P	55	2.1654	140	5.5118	33	1.2992	2.0	.080	1.0	.040	111 000	25 000	76 500	17 200	4 000	5 600
7412P	60	2.3622	150	5.9055	35	1.3780	2.0	.080	1.0	.040	119 000	26 800	86 500	19 400	3 600	5 000
7413P	65	2.5591	160	6.2992	37	1.4567	2.0	.080	1.0	.040	130 000	29 200	96 500	21 700	3 400	4 800
7414P	70	2.7559	180	7.0866	42	1.6535	2.5	.100	1.0	.040	159 000	35 700	127 000	28 600	3 000	4 300
7415P	75	2.9528	190	7.4803	45	1.7717	2.5	.100	1.0	.040	168 000	37 800	140 000	31 500	2 800	4 000
7416P	80	3.1496	200	7.8740	48	1.8898	2.5	.100	1.0	.040	183 000	41 100	156 000	35 100	2 600	3 800
7417P	85	3.3465	210	8.2677	52	2.0472	3.0	.120	1.0	.040	190 000	42 700	166 000	37 300	2 500	3 600
7418P	90	3.5433	225	8.8583	54	2.1260	3.0	.120	1.0	.040	216 000	48 600	200 000	45 000	2 400	3 400
7419P	95	3.7402	250	9.8425	55	2.1654	3.0	.120	1.0	.040	251 000	56 400	245 000	55 100	2 200	3 000
7420P	100	3.9370	265	10.4331	60	2.3622	3.0	.120	1.0	.040	276 000	62 000	275 000	61 800	2 000	2 800
7421P	105	4.1339	290	11.4173	65	2.5591	3.0	.120	1.0	.040	265 000	59 600	280 000	62 900	1 900	2 600

7400-PD

7405PD	25	.9843	80	3.1496	42	1.6535	1.5	.060	1.0	.040	65 000	14 500	47 500	10 600	5 600	8 000
7406PD	30	1.1811	90	3.5433	46	1.8110	1.5	.060	1.0	.040	78 000	17 400	58 500	13 000	5 000	7 200
7407PD	35	1.3780	100	3.9370	50	1.9685	1.5	.060	1.0	.040	97 500	22 100	76 500	17 100	4 500	6 000
7408PD	40	1.5748	110	4.3307	54	2.1260	2.0	.080	1.0	.040	114 000	25 700	90 000	20 200	4 300	5 600
7409PD	45	1.7717	120	4.7244	58	2.2835	2.0	.080	1.0	.040	138 000	31 200	110 000	24 800	3 800	5 000
7410PD	50	1.9685	130	5.1181	62	2.4409	2.0	.080	1.0	.040	156 000	34 900	129 000	28 800	3 400	4 800
7411PD	55	2.1654	140	5.5118	66	2.5984	2.0	.080	1.0	.040	182 000	40 600	153 000	34 400	3 200	4 500
7412PD	60	2.3622	150	5.9055	70	2.7559	2.0	.080	1.0	.040	195 000	43 600	173 000	38 800	2 800	4 000
7413PD	65	2.5591	160	6.2992	74	2.9134	2.0	.080	1.0	.040	212 000	47 400	193 000	43 400	2 700	3 800
7414PD	70	2.7559	180	7.0866	84	3.3071	2.5	.100	1.0	.040	260 000	58 000	255 000	57 200	2 400	3 400
7415PD	75	2.9528	190	7.4803	90	3.5433	2.5	.100	1.0	.040	276 000	61 400	280 000	63 000	2 200	3 200
7416PD	80	3.1496	200	7.8740	96	3.7795	2.5	.100	1.0	.040	296 000	66 500	310 000	69 700	2 000	3 000
7417PD	85	3.3465	210	8.2677	104	4.0945	3.0	.120	1.0	.040	307 000	69 400	335 000	74 600	2 000	2 800
7418PD	90	3.5433	225	8.8583	108	4.2520	3.0	.120	1.0	.040	351 000	78 900	400 000	89 900	1 900	2 700
7419PD	95	3.7402	250	9.8425	110	4.3307	3.0	.120	1.0	.040	410 000	92 200	490 000	110 000	1 800	2 400
7420PD	100	3.9370	265	10.4331	120	4.7244	3.0	.120	1.0	.040	449 000	101 000	550 000	124 000	1 600	2 200
7421PD	105	4.1339	290	11.4173	130	5.1181	3.0	.120	1.0	.040	436 000	96 900	560 000	126 000	1 500	2 000

¹⁾ Fillet radius indicates maximum fillet radius on shaft or in housing which bearing corner will clear.

²⁾ For thrust rating multiply C by 1.75 and C₀ by 3.85 (single) and C by 1.08 and C₀ by 1.93 (duplex).

³⁾ Listed values are for machined bronze cage, ABEC-1.

For phenolic composition cage, multiply by 1.33 for both grease and oil. For phenolic composition cage, ABEC-5 or 7, multiply by 1.86 for both grease and oil. For pressed steel cage, ABEC-1, multiply by 0.67 for grease and 0.80 for oil. The speed rating adjustment factors have been determined through historical application and practice. For a more complete explanation, see page 276

⁴⁾ Rating for one million revolutions or 500 hours at 33 1/3 RPM.

NOTES

7000-P Series
40 Degree Angular
Contact Ball Bearings
Single Bearing

Dynamic and static equivalent radial load
and life rating

Dynamic equivalent radial load

$$P = F_R \quad \text{when } F_A/F_R \leq 1.14$$

or

$$P = 0.35 F_R + 0.57 F_A \quad \text{when } F_A/F_R > 1.14$$

P = Dynamic equivalent radial load

F_R = Radial load

F_A = Thrust load

Static equivalent radial load

$$P_0 = 0.5 F_R + 0.26 F_A$$

P_0 is always $\geq F_R$

P_0 = Static equivalent radial load

F_R = Radial load

F_A = Thrust load

Life rating

$$L_{10} = \left(\frac{C}{P}\right)^3 \quad (\text{millions of revolutions})$$

or

$$L_{10h} = \frac{10^6}{60n} \left(\frac{C}{P}\right)^3 \quad (\text{Hours})$$

C = Basic dynamic radial load rating
(from single bearing tables)

P = Dynamic equivalent radial load

n = Speed in rpm

**Dynamic equivalent radial load
and life calculation examples**

Bearing size: 7309 P

Speed: 2000 RPM

Basic dynamic radial load rating (C) = 13300

Case 1Radial load (F_R) = 1750Thrust load (F_A) = 1960 $F_A/F_R = 1960/1750 = 1.12$ Since $F_A/F_R < 1.14$, equivalent load $P = F_R = 1750$

$$\text{Life (L}_{10}) = \left(\frac{C}{P}\right)^3 = \left(\frac{13300}{1750}\right)^3 = 439 \times 10^6 \text{ Rev.}$$

or

$$\begin{aligned} \text{Life (L}_{10}\text{h)} &= \frac{10^6}{60n} \left(\frac{C}{P}\right)^3 = \frac{10^6}{60 \times 2000} \left(\frac{13300}{1750}\right)^3 \\ &= 3658 \text{ Hrs} \end{aligned}$$

Case 2Radial load (F_R) = 1750Thrust load (F_A) = 2450 $F_A/F_R = 2450/1750 = 1.40$ Since $F_A/F_R > 1.14$, equivalent load (P) = $0.35 F_R + 0.57 F_A$ $P = 0.35 \times 1750 + 0.57 \times 2450 = 2009$

$$\text{Life (L}_{10}) = \left(\frac{C}{P}\right)^3 = \left(\frac{13300}{2009}\right)^3 = 290 \times 10^6 \text{ Rev.}$$

or

$$\begin{aligned} \text{Life (L}_{10}\text{h)} &= \frac{10^6}{60n} \left(\frac{C}{P}\right)^3 = \frac{10^6}{60 \times 2000} \left(\frac{13300}{2009}\right)^3 \\ &= 2417 \text{ Hrs} \end{aligned}$$

Case 3Thrust load (F_A) = 2450 $F_A/F_R = 2450/0 = \infty$ Since $F_A/F_R > 1.14$, equivalent load (P) = $0.35 F_R + 0.57 F_A$ $P = 0.57 \times 2450 = 1397$

$$\text{Life (L}_{10}) = \left(\frac{C}{P}\right)^3 = \left(\frac{13300}{1397}\right)^3 = 863 \times 10^6 \text{ Rev.}$$

or

$$\begin{aligned} \text{Life (L}_{10}\text{h)} &= \frac{10^6}{60n} \left(\frac{C}{P}\right)^3 = \frac{10^6}{60 \times 2000} \left(\frac{13300}{1397}\right)^3 \\ &= 7192 \text{ Hrs} \end{aligned}$$

***Duplex 7000-PD Series
40 Degree Angular Contact
Ball Bearings***

***Dynamic and static equivalent radial load
and life rating***

Dynamic equivalent radial load

DB or DF pair
 $P = 1.0 F_R + 0.55 F_A$ when $\frac{F_A}{F_R} \leq 1.14$

$P = 0.57 F_R + 0.93 F_A$ when $\frac{F_A}{F_R} > 1.14$

Tandem DT
 $P = 1.0 F_R$ when $\frac{F_A}{F_R} \leq 1.14$

$P = 0.35 F_R + 0.57 F_A$ when $\frac{F_A}{F_R} > 1.14$

P = Dynamic equivalent radial load

F_R = Radial load

F_A = Thrust load

Life rating

$L_{10} = \left(\frac{C}{P}\right)^3$ (millions of revolutions)

or

$L_{10h} = \frac{10^6}{60n} \left(\frac{C}{P}\right)^3$ (Hours)

For DB or DF mounting:

C = Duplex dynamic radial load
 Rating (from duplex bearing tables)

or

C = Single-row dynamic radial load
 Rating times $(i)^{0.7}$, where $i = 2$

For tandem mounting:

C = Single-row dynamic radial load
 Rating times $(i)^{0.7}$, where

i = Number of bearings in set

P = Dynamic equivalent radial load

n = Speed in rpm

Static equivalent radial load

$P_0 = 1.0 F_R + 0.52 F_A$

P_0 is always $\geq F_R$

P_0 = Static equivalent radial load

F_R = Radial load

F_A = Thrust load

Dynamic equivalent radial load and life calculation examples

Bearing size: 7309PDU (DB or DF Pair)
 Speed: 2000 RPM
 Duplex pair basic dynamic radial load
 Rating (C) = 21900 lbf

Case 1

Radial load (F_R) = 1750
 Thrust load (F_A) = 1960
 $F_A/F_R = 1960/1750 = 1.12$
 Since $F_A/F_R < 1.14$, equivalent load (P) =
 $1.0 F_R + 0.55 F_A$
 $= 1.0 \times 1750 + 0.55 \times 1960 = 2828$
 Life (L10) = $\left(\frac{C}{P}\right)^3 = \left(\frac{21900}{2828}\right)^3 = 464 \times 10^6$ Rev.
 or
 Life (L10h) = $\frac{10^6}{60n} \left(\frac{C}{P}\right)^3 = \frac{10^6}{60 \times 2000} \left(\frac{21900}{2828}\right)^3$
 $= 3867$ Hrs

Case 2

Radial load (F_R) = 1750
 Thrust load (F_A) = 2450
 $F_A/F_R = 2450/1750 = 1.40$
 Since $F_A/F_R > 1.14$, equivalent load (P) =
 $0.57 F_R + 0.93 F_A = 0.57 \times 1750 + 0.93 \times 2450$
 $= 3276$
 Life (L10) = $\left(\frac{C}{P}\right)^3 = \left(\frac{21900}{3276}\right)^3 = 299 \times 10^6$ Rev.
 or
 Life (L10h) = $\frac{10^6}{60n} \left(\frac{C}{P}\right)^3 = \frac{10^6}{60 \times 2000} \left(\frac{21900}{3276}\right)^3$
 $= 2490$ Hrs

Case 3

Thrust load (F_A) = 2450
 $F_A/F_R = 2450/0 = \infty$
 Since $F_A/F_R > 1.14$, equivalent load (P) =
 $0.57 F_R + 0.93 F_A = 0.93 \times 2450 = 2279$
 Life (L10) = $\left(\frac{C}{P}\right)^3 = \left(\frac{21900}{2279}\right)^3 = 887 \times 10^6$ Rev.
 or
 Life (L10h) = $\frac{10^6}{60n} \left(\frac{C}{P}\right)^3 = \frac{10^6}{60 \times 2000} \left(\frac{21900}{2279}\right)^3$
 $= 7392$ Hrs

Case 4

Radial load (F_R) = 1750
 $F_A/F_R = 0/1750 = 0$
 Since $F_A/F_R < 1.14$, equivalent load (P) =
 $1.0 F_R + 0.55 F_A = 1.0 \times 1750 = 1750$
 Life (L10) = $\left(\frac{C}{P}\right)^3 = \left(\frac{21900}{1750}\right)^3 = 1960 \times 10^6$ Rev.
 or
 Life (L10h) = $\frac{10^6}{60n} \left(\frac{C}{P}\right)^3 = \frac{10^6}{60 \times 2000} \left(\frac{21900}{1750}\right)^3$
 $= 16333$ Hrs

Bearing size: 7309 PDT
 3 bearings in tandem
 Speed: 2000 RPM
 Single-row basic dynamic radial load
 Rating (C) = 13300

Case 1

Thrust load (F_A) = 4200
 $F_A/F_R = 4200/0 = \infty$
 Since $F_A/F_R > 1.14$, equivalent load (P) =
 $0.35 F_R + 0.57 F_A = 0.57 \times 4200 = 2394$
 Load rating = $(i)^{0.7} \times 13300$
 $= (3)^{0.7} \times 13300 = 28697$
 Life (L10) = $\left(\frac{C}{P}\right)^3 = \left(\frac{28697}{2394}\right)^3 = 1722 \times 10^6$ Rev.
 or
 Life (L10h) = $\frac{10^6}{60n} \left(\frac{C}{P}\right)^3 = \frac{10^6}{60 \times 2000} \left(\frac{28697}{2394}\right)^3$
 $= 14350$ Hrs

Case 2

Radial load (F_R) = 3500
 Thrust load (F_A) = 4200
 $F_A/F_R = 4200/3500 = 1.20$
 Since $F_A/F_R > 1.14$, equivalent load (P) =
 $0.35 F_R + 0.57 F_A$
 $P = 0.35 \times 3500 + 0.57 \times 4200 = 3619$
 Load rating = $(i)^{0.7} \times 13300$
 $= (3)^{0.7} \times 13300 = 28697$
 Life (L10) = $\left(\frac{C}{P}\right)^3 = \left(\frac{28697}{3619}\right)^3 = 499 \times 10^6$ Rev.
 or
 Life (L10h) = $\frac{10^6}{60n} \left(\frac{C}{P}\right)^3 = \frac{10^6}{60 \times 2000} \left(\frac{28697}{3619}\right)^3$
 $= 4158$ Hrs

NOTES

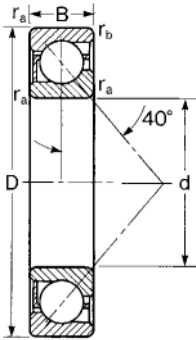

MRC angular contact bearings with a PJ suffix have one heavy race shoulder on the outer ring, opposing one heavy race shoulder and one recessed race shoulder on the inner ring. Because of this construction, it is possible for this bearing to incorporate a greater number of balls than a deep groove nonfilling notch bearing. The combination of maximum ball complement, optimum race groove depth, and the 40 degree contact angle results in high thrust load carrying capacity.

7000-PJ bearings are particularly suitable for positions where the thrust is always present in one direction. It should **not** be used where the bearing is subjected to radial load only, or combined radial and thrust load where the radial load is predominant. When heavy thrust must be taken in both directions, an angular contact bearing may be mounted in a duplex arrangement with another angular contact bearing or with a 9000-UP split inner ring bearing.

7000-PJ bearings are available with either pressed brass or machined brass, ball centered cages. The low shoulder diameters on the nonthrust sides of inner and outer rings, combined with large clearances between the land diameters and the cage, allow for large quantities of oil to flow through the bearings. The increased oil flow reduces operating temperature and theoretically increases bearing life.

ABEC Grade 3 bore tolerances reduce the range of interference fits between the shaft and bearing bore. These tighter tolerances result in closer control of preload and minimize the risk of thermal runaway.

Size	Series	Page
7200-PJ	Light—Single Bearing	110
7200-PJD	Light—Duplex Set	110
7300-PJ	Medium—Single Bearing	111
7300-PJD	Medium—Duplex Set	111
7400-PJ	Heavy—Single Bearing	112
7400-PJD	Heavy—Duplex Set	112
7000-PJ	Equivalent Load and Life	114
7000-PJ	Life Calculation Examples	115
7000-PJD	Equivalent Load and Life	116
7000-PJD	Life Calculation Examples	117

7200-PJ Light Series and 7200-PJD Light Series, Duplex

MRC Bearing Services

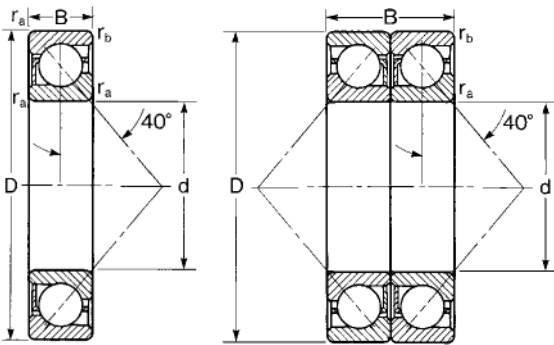

Note: ABEC 1 & 3 stocked as half-pairs, where available.

7200-PJ and -PJD Series bearings are used for heavy one-directional thrust loads or combined radial and thrust loads where thrust is predominant.

"D" indicates a duplex ground half pair matched with an identical half pair and is followed by an additional suffix letter to describe the type of duplex. See pages 236 and 237 for suffix description.

Caution: Single bearings are not to be used where only radial loads are present. For two-direction thrust loads, use duplex bearings.

Values for -PJD bearings are for back-to-back (DB) or face-to-face (DF) mounting arrangements.

MRC Bearing Number	Bore		Outside Diameter D		Width B		Fillet Radius ¹⁾				Basic Radial Load Rating ²⁾				Speed Rating ³⁾	
											Dynamic C _d ⁴⁾		Static C ₀		Grease	Oil
	d	in	mm	in	mm	in	r _a	r _b	mm	in	N	lbf	N	lbf	RPM	RPM
7205-PJ	25	.9843	52	2.0472	15	.5906	1.0	.04	.60	.024	15 600	3 510	10 200	2 290	10 000	15 000
7206-PJ	30	1.1811	62	2.4409	16	.6299	1.0	.04	.60	.024	23 800	5 350	15 600	3 510	8 500	12 000
7207-PJ	35	1.3780	72	2.8346	17	.6693	1.0	.04	.60	.024	30 700	6 900	20 800	4 680	8 000	11 000
7208-PJ	40	1.5748	80	3.1496	18	.7087	1.0	.04	.60	.024	36 400	8 180	26 000	5 850	7 000	9 500
7209-PJ	45	1.7717	85	3.3465	19	.7480	1.0	.04	.60	.024	37 700	8 480	28 000	6 290	6 700	9 000
7210-PJ	50	1.9685	90	3.5433	20	.7874	1.0	.04	.60	.024	39 000	8 770	30 500	6 860	6 000	8 000
7211-PJ	55	2.1654	100	3.9370	21	.8268	1.5	.06	1.0	.040	48 800	11 000	38 000	8 540	5 600	7 500
7212-PJ	60	2.3622	110	4.3307	22	.8661	1.5	.06	1.0	.040	57 200	12 900	45 500	10 200	5 000	6 700
7213-PJ	65	2.5591	120	4.7244	23	.9055	1.5	.06	1.0	.040	66 300	14 900	54 000	12 100	4 500	6 000
7214-PJ	70	2.7559	125	4.9213	24	.9449	1.5	.06	1.0	.040	71 500	16 100	60 000	13 500	4 300	5 600
7215-PJ	75	2.9528	130	5.1181	25	.9843	1.5	.06	1.0	.040	72 800	16 400	64 000	14 400	4 000	5 300
7216-PJ	80	3.1496	140	5.5118	26	1.0236	2.0	.08	1.0	.040	83 200	18 700	73 500	16 500	3 800	5 000
7217-PJ	85	3.3465	150	5.9055	28	1.1024	2.0	.08	1.0	.040	95 600	21 500	83 000	18 700	3 600	4 800
7218-PJ	90	3.5433	160	6.2992	30	1.1811	2.0	.08	1.0	.040	108 000	24 300	96 500	21 700	3 400	4 500

7200-PJD

7205-PJD	25	.9843	52	2.0472	30	1.1811	1.0	.04	.60	.024	25 100	5 640	20 400	4 590	8 500	12 000
7206-PJD	30	1.1811	62	2.4409	32	1.2598	1.0	.04	.60	.024	39 000	8 770	31 000	6 970	7 500	10 000
7207-PJD	35	1.3780	72	2.8346	34	1.3386	1.0	.04	.60	.024	50 700	11 400	41 500	9 360	6 300	8 500
7208-PJD	40	1.5748	80	3.1496	36	1.4173	1.0	.04	.60	.024	59 200	13 300	52 000	11 700	5 600	7 500
7209-PJD	45	1.7717	85	3.3465	38	1.4961	1.0	.04	.60	.024	61 800	13 900	56 000	12 600	5 300	7 000
7210-PJD	50	1.9685	90	3.5433	40	1.5748	1.0	.04	.60	.024	63 700	14 300	61 000	13 700	4 800	6 300
7211-PJD	55	2.1654	100	3.9370	42	1.6535	1.5	.06	1.0	.040	78 000	17 500	76 500	17 200	4 500	6 000
7212-PJD	60	2.3622	110	4.3307	44	1.7323	1.5	.06	1.0	.040	93 600	21 000	91 500	20 600	4 000	5 300
7213-PJD	65	2.5591	120	4.7244	46	1.8110	1.5	.06	1.0	.040	108 000	24 300	108 000	24 300	3 600	4 800
7214-PJD	70	2.7559	125	4.9213	48	1.8898	1.5	.06	1.0	.040	114 000	25 600	118 000	26 500	3 400	4 500
7215-PJD	75	2.9528	130	5.1181	50	1.9685	1.5	.06	1.0	.040	119 000	26 800	127 000	28 600	3 200	4 300
7216-PJD	80	3.1496	140	5.5118	52	2.0472	2.0	.08	1.0	.040	135 000	30 300	146 000	32 800	3 000	4 000
7217-PJD	85	3.3465	150	5.9055	56	2.2047	2.0	.08	1.0	.040	156 000	35 100	166 000	37 300	2 800	3 800
7218-PJD	90	3.5433	160	6.2992	60	2.3622	2.0	.08	1.0	.040	178 000	40 000	193 000	43 400	2 600	3 600

¹⁾ Fillet radius indicates maximum fillet radius on shaft or in housing which bearing corner will clear.

²⁾ For thrust rating multiply C by 1.75 and C₀ by 3.85 (single) and C by 1.08 and C₀ by 1.93 (duplex).

³⁾ Listed values are for pressed brass and steel or polyamide cage.

The values have been determined through historical application and practice. For a more complete explanation, see page 276

⁴⁾ Rating for one million revolutions or 500 hours at 33 1/3 RPM.

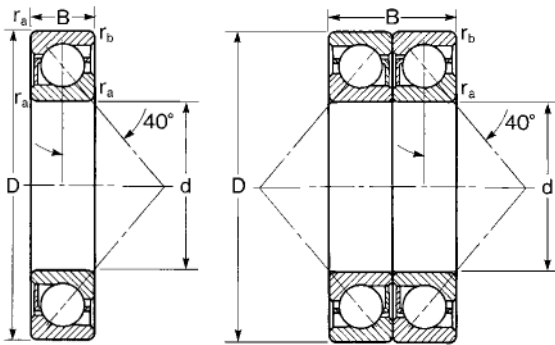

Note: ABEC 1 & 3 stocked as half-pairs, where available.

7300-PJ and -PJD Series bearings are used for very heavy one-directional thrust loads or combined radial and thrust loads where thrust is predominant.

"D" indicates a duplex ground half pair matched with an identical half pair and is followed by an additional suffix letter to describe the type of duplex. See pages 236 and 237 for suffix description.

Caution: Single bearings are not to be used where only radial loads are present. For two-direction thrust loads, use duplex bearings.

Values for -PJD bearings are for back-to-back (DB) or face-to-face (DF) mounting arrangements.

MRC Bearing Number	Bore d mm in		Outside Diameter D mm in		Width B mm in		Fillet Radius ¹⁾ r _a r _b mm in mm in				Basic Radial Load Rating ²⁾				Speed Rating ³⁾	
											Dynamic C _d ⁴⁾		Static C ₀		Grease	Oil
											N	lbf	N	lbf	RPM	RPM
7304-PJ	20	.7874	52	2.0472	15	.5906	1.0	.04	.60	.024	19 000	4 270	10 200	2 290	11 000	16 000
7305-PJ	25	.9843	62	2.4409	17	.6693	1.0	.04	.60	.024	26 000	5 850	15 600	3 510	9 000	13 000
7306-PJ	30	1.1811	72	2.8346	19	.7480	1.0	.04	.60	.024	34 500	7 760	21 200	4 770	8 000	11 000
7307-PJ	35	1.3780	80	3.1496	21	.8268	1.5	.06	1.0	.040	39 000	8 770	24 500	5 510	7 500	10 000
7308-PJ	40	1.5748	90	3.5433	23	.9055	1.5	.06	1.0	.040	49 400	11 100	33 500	7 530	6 700	9 000
7309-PJ	45	1.7717	100	3.9370	25	.9843	1.5	.06	1.0	.040	60 500	13 600	41 500	9 330	6 000	8 000
7310-PJ	50	1.9685	110	4.3307	27	1.0630	2.0	.08	1.0	.040	74 100	16 700	51 000	11 500	5 300	7 000
7311-PJ	55	2.1654	120	4.7244	29	1.1417	2.0	.08	1.0	.040	85 200	19 200	60 000	13 500	4 800	6 300
7312-PJ	60	2.3622	130	5.1181	31	1.2205	2.0	.08	1.0	.040	95 600	21 500	69 500	15 600	4 500	6 000
7313-PJ	65	2.5591	140	5.5118	33	1.2992	2.0	.08	1.0	.040	108 000	24 300	80 000	18 000	4 300	5 600
7314-PJ	70	2.7559	150	5.9055	35	1.3780	2.0	.08	1.0	.040	119 000	26 800	90 000	20 200	3 800	5 000
7315-PJ	75	2.9528	160	6.2992	37	1.4567	2.0	.08	1.0	.040	133 000	29 900	106 000	23 800	3 600	4 800
7316-PJ	80	3.1496	170	6.6929	39	1.5354	2.0	.08	1.0	.040	143 000	32 100	118 000	26 500	3 400	4 500
7317-PJ	85	3.3465	180	7.0866	41	1.6142	2.5	.10	1.0	.040	153 000	34 400	132 000	29 700	3 200	4 300
7318-PJ	90	3.5433	190	7.4803	43	1.6299	2.5	.10	1.0	.040	165 000	37 100	146 000	32 800	3 000	4 000
7319-PJ	95	3.7402	200	7.8740	45	1.7717	2.5	.10	1.0	.040	178 000	40 000	163 000	36 600	2 800	3 800
7300-PJD																
7304-PJD	20	.7874	52	2.0472	30	1.1811	1.0	.04	.60	.024	30 700	6 900	20 800	4 680	9 000	13 000
7305-PJD	25	.9843	62	2.4409	34	1.3386	1.0	.04	.60	.024	42 300	9 510	31 000	6 970	7 500	10 000
7306-PJD	30	1.1811	72	2.8346	38	1.4961	1.0	.04	.60	.024	55 900	12 600	42 500	9 550	6 700	9 000
7307-PJD	35	1.3780	80	3.1496	42	1.6535	1.5	.06	1.0	.040	62 400	14 000	49 000	11 000	6 000	8 000
7308-PJD	40	1.5748	90	3.5433	46	1.8110	1.5	.06	1.0	.040	79 300	17 800	65 500	14 700	5 300	7 000
7309-PJD	45	1.7717	100	3.9370	50	1.9685	1.5	.06	1.0	.040	97 500	21 900	81 500	18 300	4 800	6 300
7310-PJD	50	1.9685	110	4.3307	54	2.1260	2.0	.08	1.0	.040	119 000	26 800	102 000	22 900	4 300	5 600
7311-PJD	55	2.1654	120	4.7244	58	2.2835	2.0	.08	1.0	.040	138 000	31 000	120 000	27 000	3 800	5 000
7312-PJD	60	2.3622	130	5.1181	62	2.4409	2.0	.08	1.0	.040	156 000	35 100	140 000	31 500	3 600	4 800
7313-PJD	65	2.5591	140	5.5118	66	2.5984	2.0	.08	1.0	.040	174 000	39 100	160 000	36 000	3 200	4 300
7314-PJD	70	2.7559	150	5.9055	70	2.7559	2.0	.08	1.0	.040	195 000	43 800	180 000	40 500	3 000	4 000
7315-PJD	75	2.9528	160	6.2992	74	2.9134	2.0	.08	1.0	.040	212 000	47 700	212 000	47 700	2 800	3 800
7316-PJD	80	3.1496	170	6.6929	78	3.0709	2.0	.08	1.0	.040	229 000	51 500	236 000	53 100	2 600	3 600
7317-PJD	85	3.3465	180	7.0866	82	3.2283	2.5	.10	1.0	.040	251 000	56 400	265 000	59 600	2 400	3 400
7318-PJD	90	3.5433	190	7.4803	86	3.3858	2.5	.10	1.0	.040	270 000	60 700	290 000	65 200	2 200	3 200
7319-PJD	95	3.7402	200	7.8740	90	3.5433	2.5	.10	1.0	.040	286 000	64 300	325 000	73 100	2 000	3 000

¹⁾ Fillet radius indicates maximum fillet radius on shaft or in housing which bearing corner will clear.

²⁾ For thrust rating multiply C by 1.75 and C₀ by 3.85 (single) and C by 1.08 and C₀ by 1.93 (duplex).

³⁾ Listed values are for pressed brass and steel or polyamide cage.

The values have been determined through historical application and practice. For a more complete explanation, see page 276

⁴⁾ Rating for one million revolutions or 500 hours at 33 1/3 RPM.

7400-PJ Heavy Series
7400-PJD Heavy Series, Duplex

MRC Bearing Services

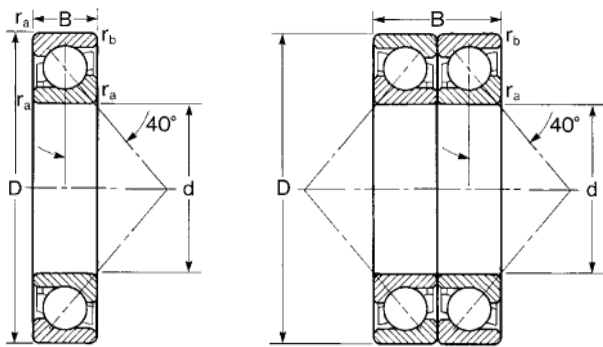

7400-PJ and -PJD Series bearings are similar to the 7200-PJ and 7300-PJ Series but are heavier sectioned and are used for very heavy thrust loads or combined radial and thrust loads where thrust is predominant.

"D" indicates a duplex ground half pair matched with an identical half pair and is followed by an additional suffix letter to describe the type of duplex. See pages 236 and 237 for suffix description.

Caution: Single bearings are not to be used where only radial loads are present. For two-direction thrust loads, use duplex bearings.

Values for -D bearings are for back-to-back (DB) or face-to-face (DF) mounting arrangements.

Note: ABEC 1 & 3 stocked as half-pairs, where available.

MRC Bearing Number	Bore		Outside Diameter D		Width B		Fillet Radius ¹⁾				Basic Radial Load Rating ²⁾				Speed Rating ³⁾	
											Dynamic C ⁴⁾		Static C ₀		Grease RPM	Oil RPM
	d	in	mm	in	mm	in	r _a	r _b	mm	in	N	lbf	N	lbf		
7405-PJ	25	.9843	80	3.1496	21	.8268	1.5	.060	1.0	.040	39 700	8 920	23 600	5 310	7 000	10 000
7406-PJ	30	1.1811	90	3.5433	23	.9055	1.5	.060	1.0	.040	47 500	10 700	29 000	6 520	6 300	9 000
7407-PJ	35	1.3780	100	3.9370	25	.9843	1.5	.060	1.0	.040	60 500	13 600	38 000	8 540	5 600	7 500
7408-PJ	40	1.5748	110	4.3307	27	1.0630	2.0	.080	1.0	.040	70 200	15 800	45 000	10 100	5 300	7 000
7409-PJ	45	1.7717	120	4.7244	29	1.1417	2.0	.080	1.0	.040	85 200	19 200	55 000	12 400	4 800	6 300
7410-PJ	50	1.9685	130	5.1181	31	1.2205	2.0	.080	1.0	.040	95 600	21 500	64 000	14 400	4 300	6 000
7411-PJ	55	2.1654	140	5.5118	33	1.2992	2.0	.080	1.0	.040	111 000	25 000	76 500	17 200	4 000	5 600
7412-PJ	60	2.3622	150	5.9055	35	1.3780	2.0	.080	1.0	.040	119 000	26 800	86 500	19 400	3 600	5 000
7413-PJ	65	2.5591	160	6.2992	37	1.4567	2.0	.080	1.0	.040	130 000	29 200	96 500	21 700	3 400	4 800
7414-PJ	70	2.7559	180	7.0866	42	1.6535	2.5	.100	1.0	.040	159 000	35 700	127 000	28 600	3 000	4 300
7415-PJ	75	2.9528	190	7.4803	45	1.7717	2.5	.100	1.0	.040	168 000	37 800	140 000	31 500	2 800	4 000
7416-PJ	80	3.1496	200	7.8740	48	1.8898	2.5	.100	1.0	.040	183 000	41 100	156 000	35 100	2 600	3 800
7417-PJ	85	3.3465	210	8.2677	52	2.0472	3.0	.120	1.0	.040	190 000	42 700	166 000	37 300	2 500	3 600
7418-PJ	90	3.5433	225	8.8583	54	2.1260	3.0	.120	1.0	.040	216 000	48 600	200 000	45 000	2 400	3 400
7419-PJ	95	3.7402	250	9.8425	55	2.1654	3.0	.120	1.0	.040	251 000	56 400	245 000	55 100	2 200	3 000
7420-PJ	100	3.9370	265	10.4331	60	2.3622	3.0	.120	1.0	.040	276 000	62 000	275 000	61 800	2 000	2 800
7421-PJ	105	4.1339	290	11.4173	65	2.5591	3.0	.120	1.0	.040	265 000	59 600	280 000	62 900	1 900	2 600

7400-PJD

7405-PJD	25	.9843	80	3.1496	42	1.6535	1.5	.060	1.0	.040	65 000	14 500	47 500	10 600	5 600	8 000
7406-PJD	30	1.1811	90	3.5433	46	1.8110	1.5	.060	1.0	.040	78 000	17 400	58 500	13 000	5 000	7 200
7407-PJD	35	1.3780	100	3.9370	50	1.9685	1.5	.060	1.0	.040	97 500	22 100	76 500	17 100	4 500	6 000
7408-PJD	40	1.5748	110	4.3307	54	2.1260	2.0	.080	1.0	.040	114 000	25 700	90 000	20 200	4 300	5 600
7409-PJD	45	1.7717	120	4.7244	58	2.2835	2.0	.080	1.0	.040	138 000	31 200	110 000	24 800	3 800	5 000
7410-PJD	50	1.9685	130	5.1181	62	2.4409	2.0	.080	1.0	.040	156 000	34 900	129 000	28 800	3 400	4 800
7411-PJD	55	2.1654	140	5.5118	66	2.5984	2.0	.080	1.0	.040	182 000	40 600	153 000	34 400	3 200	4 500
7412-PJD	60	2.3622	150	5.9055	70	2.7559	2.0	.080	1.0	.040	195 000	43 600	173 000	38 800	2 800	4 000
7413-PJD	65	2.5591	160	6.2992	74	2.9134	2.0	.080	1.0	.040	212 000	47 400	193 000	43 400	2 700	3 800
7414-PJD	70	2.7559	180	7.0866	84	3.3071	2.5	.100	1.0	.040	260 000	58 000	255 000	57 200	2 400	3 400
7415-PJD	75	2.9528	190	7.4803	90	3.5433	2.5	.100	1.0	.040	276 000	61 400	280 000	63 000	2 200	3 200
7416-PJD	80	3.1496	200	7.8740	96	3.7795	2.5	.100	1.0	.040	296 000	66 500	310 000	69 700	2 000	3 000
7417-PJD	85	3.3465	210	8.2677	104	4.0945	3.0	.120	1.0	.040	307 000	69 400	335 000	74 600	2 000	2 800
7418-PJD	90	3.5433	225	8.8583	108	4.2520	3.0	.120	1.0	.040	351 000	78 900	400 000	89 900	1 900	2 700
7419-PJD	95	3.7402	250	9.8425	110	4.3307	3.0	.120	1.0	.040	410 000	92 200	490 000	110 000	1 800	2 400
7420-PJD	100	3.9370	265	10.4331	120	4.7244	3.0	.120	1.0	.040	449 000	101 000	550 000	124 000	1 600	2 200
7421-PJD	105	4.1339	290	11.4173	130	5.1181	3.0	.120	1.0	.040	436 000	96 900	560 000	126 000	1 500	2 000

- 1) Fillet radius indicates maximum fillet radius on shaft or in housing which bearing corner will clear.
- 2) For thrust rating multiply C by 1.75 and C₀ by 3.85 (single) and C by 1.08 and C₀ by 1.93 (duplex).
- 3) Listed values are for machined bronze cage, ABEC-1.
The values have been determined through historical application and practice. For a more complete explanation, see page 276
- 4) Rating for one million revolutions or 500 hours at 33 1/3 RPM.

NOTES

7000-PJ Series
40 Degree Angular
Contact Ball Bearings
Single Bearing

Dynamic and static equivalent radial load
and life rating

Dynamic equivalent radial load

$$P = F_R \quad \text{when } F_A/F_R \leq 1.14$$

or

$$P = 0.35 F_R + 0.57 F_A \quad \text{when } F_A/F_R > 1.14$$

P = Dynamic equivalent radial load

F_R = Radial load

F_A = Thrust load

Static equivalent radial load

$$P_0 = 0.5 F_R + 0.26 F_A$$

P_0 is always $\geq F_R$

P_0 = Static equivalent radial load

F_R = Radial load

F_A = Thrust load

Life rating

$$L_{10} = \left(\frac{C}{P}\right)^3 \quad (\text{millions of revolutions})$$

or

$$L_{10h} = \frac{10^6}{60n} \left(\frac{C}{P}\right)^3 \quad (\text{Hours})$$

C = Basic dynamic radial load rating
(from single-row bearing tables)

P = Dynamic equivalent radial load

n = Speed in rpm

***Dynamic equivalent radial load
and life calculation examples***

Bearing size: 7309 PJ

Speed: 2000 RPM

Basic dynamic radial load rating (C) = 13600

Case 1Radial load (F_R) = 1750Thrust load (F_A) = 1960 $F_A/F_R = 1960/1750 = 1.12$ Since $F_A/F_R < 1.14$, Equivalent load (P) = $F_R = 1750$

$$\text{Life (L}_{10}) = \left(\frac{C}{P}\right)^3 = \left(\frac{13600}{1750}\right)^3 = 469 \times 10^6 \text{ Rev.}$$

or

$$\begin{aligned} \text{Life (L}_{10}\text{h)} &= \frac{10^6}{60n} \left(\frac{C}{P}\right)^3 = \frac{10^6}{60 \times 2000} \left(\frac{13600}{1750}\right)^3 \\ &= 3911 \text{ Hrs} \end{aligned}$$

Case 2Radial load (F_R) = 1750Thrust load (F_A) = 2450 $F_A/F_R = 2450/1750 = 1.40$ Since $F_A/F_R > 1.14$, equivalent load (P) = $0.35 F_R + 0.57 F_A$ $P = 0.35 \times 1750 + 0.57 \times 2450 = 2009$

$$\text{Life (L}_{10}) = \left(\frac{C}{P}\right)^3 = \left(\frac{13600}{2009}\right)^3 = 310 \times 10^6 \text{ Rev.}$$

or

$$\begin{aligned} \text{Life (L}_{10}\text{h)} &= \frac{10^6}{60n} \left(\frac{C}{P}\right)^3 = \frac{10^6}{60 \times 2000} \left(\frac{13600}{2009}\right)^3 \\ &= 2585 \text{ Hrs} \end{aligned}$$

Case 3Thrust load (F_A) = 2450 $F_A/F_R = 2450/0 = \infty$ Since $F_A/F_R > 1.14$, equivalent load (P) = $0.35 F_R + 0.57 F_A$ $P = 0.57 \times 2450 = 1397$

$$\text{Life (L}_{10}) = \left(\frac{C}{P}\right)^3 = \left(\frac{13600}{1397}\right)^3 = 923 \times 10^6 \text{ Rev.}$$

or

$$\begin{aligned} \text{Life (L}_{10}\text{h)} &= \frac{10^6}{60n} \left(\frac{C}{P}\right)^3 = \frac{10^6}{60 \times 2000} \left(\frac{13600}{1397}\right)^3 \\ &= 7688 \text{ Hrs} \end{aligned}$$

***Duplex 7000-PJD Series
40 Degree Angular Contact
Ball Bearings***

***Dynamic and static equivalent radial load
and life rating***

Dynamic equivalent radial load

DB or DF pair
 $P = 1.0 F_R + 0.55 F_A$ when $\frac{F_A}{F_R} \leq 1.14$

$P = 0.57 F_R + 0.93 F_A$ when $\frac{F_A}{F_R} > 1.14$

Tandem DT
 $P = 1.0 F_R$ when $\frac{F_A}{F_R} \leq 1.14$

$P = 0.35 F_R + 0.57 F_A$ when $\frac{F_A}{F_R} > 1.14$

P = Dynamic equivalent radial load

F_R = Radial load

F_A = Thrust load

Life rating

$L_{10} = \left(\frac{C}{P}\right)^3$ (millions of revolutions)

or

$L_{10h} = \frac{10^6}{60n} \left(\frac{C}{P}\right)^3$ (Hours)

For DB or DF mounting:

C = Duplex dynamic radial load Rating (from duplex bearing tables)

or

C = Single-row dynamic radial load Rating times $(i)^{0.7}$, where $i = 2$

For tandem mounting:

C = Single-row dynamic radial load Rating times $(i)^{0.7}$, where

i = Number of bearings in set

P = Dynamic equivalent radial load

n = Speed in rpm

Static equivalent radial load

$P_0 = 1.0 F_R + 0.52 F_A$

P_0 is always $\geq F_R$

P_0 = Static equivalent radial load

F_R = Radial load

F_A = Thrust load

Dynamic equivalent radial load and life calculation examples

Bearing size: 7309 PJDU (DB or DF Pair)
Speed: 2000 RPM
Duplex pair basic dynamic radial load
Rating (C) = 21900 lbf

Case 1

Radial load (F_R) = 1750
Thrust load (F_A) = 1960
 $F_A/F_R = 1960/1750 = 1.12$
Since $F_A/F_R < 1.14$, equivalent load (P) =
 $1.0 F_R + 0.55 F_A$
 $= 1.0 \times 1750 + 0.55 \times 1960 = 2828$
Life (L10) = $\left(\frac{C}{P}\right)^3 = \left(\frac{21900}{2828}\right)^3 = 464 \times 10^6$ Rev.
or
Life (L10h) = $\frac{10^6}{60n} \left(\frac{C}{P}\right)^3 = \frac{10^6}{60 \times 2000} \left(\frac{21900}{2828}\right)^3$
 $= 3867$ Hrs

Case 2

Radial load (F_R) = 1750
Thrust load (F_A) = 2450
 $F_A/F_R = 2450/1750 = 1.40$
Since $F_A/F_R > 1.14$, equivalent load (P) =
 $0.57 F_R + 0.93 F_A = 0.57 \times 1750 + 0.93 \times 2450$
 $= 3276$
Life (L10) = $\left(\frac{C}{P}\right)^3 = \left(\frac{21900}{3276}\right)^3 = 299 \times 10^6$ Rev.
or
Life (L10h) = $\frac{10^6}{60n} \left(\frac{C}{P}\right)^3 = \frac{10^6}{60 \times 2000} \left(\frac{21900}{3276}\right)^3$
 $= 2490$ Hrs

Case 3

Thrust load (F_A) = 2450
 $F_A/F_R = 2450/0 = \infty$
Since $F_A/F_R > 1.14$, equivalent load (P) =
 $0.57 F_R + 0.93 F_A = 0.93 \times 2450 = 2279$
Life (L10) = $\left(\frac{C}{P}\right)^3 = \left(\frac{21900}{2279}\right)^3 = 887 \times 10^6$ Rev.
or
Life (L10h) = $\frac{10^6}{60n} \left(\frac{C}{P}\right)^3 = \frac{10^6}{60 \times 2000} \left(\frac{21900}{2279}\right)^3$
 $= 7392$ Hrs

Case 4

Radial load (F_R) = 1750
 $F_A/F_R = 0/1750 = 0$
Since $F_A/F_R < 1.14$, equivalent load (P) =
 $1.0 F_R + 0.55 F_A = 1.0 \times 1750 = 1750$
Life (L10) = $\left(\frac{C}{P}\right)^3 = \left(\frac{21900}{1750}\right)^3 = 1960 \times 10^6$ Rev.
or
Life (L10h) = $\frac{10^6}{60n} \left(\frac{C}{P}\right)^3 = \frac{10^6}{60 \times 2000} \left(\frac{21900}{1750}\right)^3$
 $= 16333$ Hrs

Bearing size: 7309 PJDT
3 bearings in tandem
Speed: 2000 RPM
Single-row basic dynamic radial load
Rating (C) = 13600

Case 1

Thrust load (F_A) = 4200
 $F_A/F_R = 4200/0 = \infty$
Since $F_A/F_R > 1.14$, equivalent load (P) =
 $0.35 F_R + 0.57 F_A = 0.57 \times 4200 = 2394$
Load rating = (i)^{0.7} × 13600
 $= (3)^{0.7} \times 13600 = 29344$
Life (L10) = $\left(\frac{C}{P}\right)^3 = \left(\frac{29344}{2394}\right)^3 = 1842 \times 10^6$ Rev.
or
Life (L10h) = $\frac{10^6}{60n} \left(\frac{C}{P}\right)^3 = \frac{10^6}{60 \times 2000} \left(\frac{29344}{2394}\right)^3$
 $= 15346$ Hrs

Case 2

Radial load (F_R) = 3500
Thrust load (F_A) = 4200
 $F_A/F_R = 4200/3500 = 1.20$
Since $F_A/F_R > 1.14$, equivalent load (P) =
 $0.35 F_R + 0.57 F_A$
 $P = 0.35 \times 3500 + 0.57 \times 4200 = 3619$
Load rating = (i)^{0.7} × 13600
 $= (3)^{0.7} \times 13600 = 29344$
Life (L10) = $\left(\frac{C}{P}\right)^3 = \left(\frac{29344}{3619}\right)^3 = 533 \times 10^6$ Rev.
or
Life (L10h) = $\frac{10^6}{60n} \left(\frac{C}{P}\right)^3 = \frac{10^6}{60 \times 2000} \left(\frac{29344}{3619}\right)^3$
 $= 4442$ Hrs

NOTES

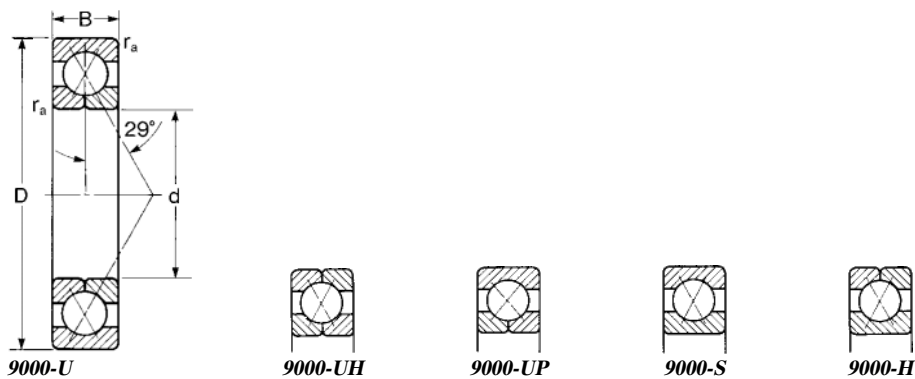

Demand for a two-directional maximum thrust capacity bearing requiring minimum space has resulted in extensive use of the MRC 9000 Series bearings.

9000-U is the standard construction. It is an angular contact bearing with one-piece outer rings and two-piece inner ring construction. It has maximum ball complement and a one-piece machined ball cage. The cage construction completely retains the balls for unit handling in installation. The bearings of this series have similar internal characteristics and identical external dimensions to bearings in the MRC 7000 Series, which are angular contact, one-direction thrust bearings.

9000-UH has two-piece construction of both inner and outer rings. The use of this bearing is confined to those applications where end play must be held to an absolute minimum.

9000-UP is similar to the 9000-U, except that its internal characteristics provide greater two-directional thrust capacity for applications in which such capacity is the primary requirement. Can be used in combination with a corresponding duplex ground 7000-P bearing.

9000-S has one-piece construction of both inner and outer ring. Assembly of the ball complement is accomplished by eccentric displacement of the outer ring. The use of this type is recommended where end play and tilt must be held to a minimum, but where maximum capacity is not required.

9000-H has a two-piece outer ring and a one-piece inner ring. Recommended only where the outer ring can be positively clamped. When duplexed, bearing can be used with a corresponding duplex-ground 7000 Series bearing.

Size	Series	Page
9100-UK	Extra Light—29 Degree Contact Angle	120
9200-U	Light—29 Degree Contact Angle	120
9300-U	Medium—29 Degree Contact Angle	121
9200-UP	Light—40 Degree Contact Angle	125
9300-UP	Medium—40 Degree Contact Angle	125
9000-U	Equivalent Load and Life	123
9000-U	Life Calculation Examples	124
9000-UP	Equivalent Load and Life	126
9000-UP	Life Calculation Examples	127

9100-UK and 9200-U Split Ring Angular Contact Bearings

MRC Bearing Services

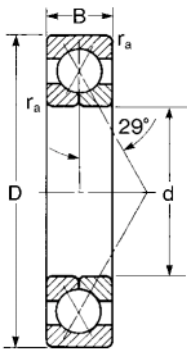

For duplex sets of 7000 and 9000 series bearings see page 239.

MRC Bearing Number	Bore		Outside Diameter D		Width B		Fillet Radius ¹⁾ r _a		Basic Radial Load Rating ²⁾				Speed Rating ³⁾	
									Dynamic C _d ⁴⁾		Static C ₀		Grease	Oil
	d	mm	in	mm	in	mm	in	mm	in	N	lbf	N	lbf	RPM
9100-UK	10	.3937	26	1.0236	8	.3150	.30	.012	4 620	1 040	2 080	468	30 000	39 000
9101-UK	12	.4724	28	1.1024	8	.3150	.30	.012	5 070	1 140	2 500	562	25 000	32 000
9102-UK	15	.5906	32	1.2598	9	.3543	.30	.012	5 400	1 210	2 900	652	22 000	28 000
9103-UK	17	.6693	35	1.3780	10	.3937	.30	.012	7 610	1 710	4 250	955	19 000	25 000
9104-UK	20	.7874	42	1.6535	12	.4724	.64	.025	9 560	2 150	5 600	1 260	16 000	21 000
9105-UK	25	.9843	47	1.8504	12	.4724	.64	.025	10 600	2 380	6 950	1 560	12 000	16 000
9106-UK	30	1.1811	55	2.1654	13	.5118	1.0	.04	13 800	3 100	9 650	2 170	11 000	14 000
9107-UK	35	1.3780	62	2.4409	14	.5512	1.0	.04	16 800	3 780	12 000	2 700	9 200	12 000
9108-UK	40	1.5748	68	2.6772	15	.5906	1.0	.04	17 200	3 870	13 200	2 970	8 500	11 000
9109-UK	45	1.7717	75	2.9528	16	.6299	1.0	.04	21 200	4 770	17 000	3 820	7 500	9 800
9110-UK	50	1.9685	80	3.1496	16	.6299	1.0	.04	22 100	4 970	18 300	4 110	6 900	9 000
9111-UK	55	2.1654	90	3.5433	18	.7087	1.0	.04	29 600	6 650	25 500	5 730	6 300	8 200
9112-UK	60	2.3622	95	3.7402	18	.7087	1.0	.04	30 200	6 790	27 000	6 070	5 700	7 400
9113-UK	65	2.5591	100	3.9370	18	.7087	1.0	.04	31 200	7 010	29 000	6 520	5 400	7 000
9114-UK	70	2.7559	110	4.3307	20	.7874	1.0	.04	34 500	7 760	35 500	7 980	5 000	6 500
9115-UK	75	2.9528	115	4.5276	20	.7874	1.0	.04	37 700	8 480	37 500	8 430	4 700	6 100
9116-UK	80	3.1496	125	4.9213	22	.8661	1.0	.04	48 800	11 000	49 000	11 000	4 500	5 800
9117-UK	85	3.3465	130	5.1181	22	.8661	1.0	.04	49 400	11 100	52 000	11 700	4 100	5 300
9118-UK	90	3.5433	140	5.5118	24	.9449	1.5	.06	58 500	13 200	61 000	13 700	3 800	4 900
9119-UK	95	3.7402	145	5.7087	24	.9449	1.5	.06	71 500	16 100	71 000	16 000	3 600	4 700
9120-UK	100	3.9370	150	5.9055	24	.9449	1.5	.06	62 400	14 000	68 000	15 300	3 500	4 500
9121-UK	105	4.1339	160	6.2992	26	1.0236	2.0	.08	74 100	16 700	80 000	18 000	3 300	4 300
9122-UK	110	4.3307	170	6.6929	28	1.1024	2.0	.08	87 100	19 600	91 500	20 600	3 200	3 800
9200-U														
9202-U	15	.5906	35	1.3780	11	.4331	.64	.025	8 060	1 810	4 750	1 070	20 000	26 000
9203-U	17	.6693	40	1.5748	12	.4724	.64	.025	9 950	2 240	6 100	1 370	18 000	23 000
9204-U	20	.7874	47	1.8504	14	.5512	1.0	.04	11 900	2 680	7 100	1 600	15 000	19 000
9205-U	25	.9843	52	2.0472	15	.5906	1.0	.04	14 300	3 210	8 800	1 980	12 000	16 000
9206-U	30	1.1811	62	2.4409	16	.6299	1.0	.04	16 800	3 780	11 800	2 550	10 000	13 000
9207-U	35	1.3780	72	2.8346	17	.6693	1.0	.04	23 400	5 260	17 000	3 820	9 200	12 000
9208-U	40	1.5748	80	3.1496	18	.7087	1.0	.04	30 700	6 900	22 800	5 130	7 700	10 000
9209-U	45	1.7717	85	3.3465	19	.7480	1.0	.04	31 900	7 170	25 000	5 620	7 300	9 500
9210-U	50	1.9685	90	3.5433	20	.7874	1.0	.04	33 200	7 460	27 000	6 070	6 400	8 300
9211-U	55	2.1654	100	3.9370	21	.8268	1.5	.06	48 800	11 000	37 500	8 430	6 000	7 800
9212-U	60	2.3622	110	4.3307	22	.8661	1.5	.06	52 700	11 800	44 000	9 890	5 400	7 000
9213-U	65	2.5591	120	4.7244	23	.9055	1.5	.06	63 700	14 300	54 000	12 100	4 900	6 400
9214-U	70	2.7559	125	4.9213	24	.9449	1.5	.06	63 700	14 300	55 000	12 400	4 600	6 000
9215-U	75	2.9528	130	5.1181	25	.9843	1.5	.06	76 100	17 100	65 500	14 700	4 300	5 600
9216-U	80	3.1496	140	5.5118	26	1.0236	1.5	.08	78 000	17 500	71 000	16 000	4 100	5 300
9217-U	85	3.3465	150	5.9055	28	1.1024	2.0	.08	90 400	20 300	85 000	19 100	3 800	4 900
9218-U	90	3.5433	160	6.2992	30	1.1811	2.0	.08	112 000	25 100	98 000	22 000	3 600	4 700
9219-U	95	3.7402	170	6.6929	32	1.2598	2.0	.08	117 000	26 300	108 000	24 300	3 500	4 500
9220-U	100	3.9370	180	7.0866	34	1.3386	2.0	.08	130 000	29 200	122 000	27 400	3 200	4 100
9221-U	105	4.1339	190	7.4803	36	1.4173	2.0	.08	148 000	33 300	137 000	30 800	3 000	3 900
9222-U	110	4.3307	200	7.8740	38	1.4961	2.0	.08	163 000	36 600	156 000	35 100	2 900	3 800

¹⁾ Fillet radius indicates maximum fillet radius on shaft or in housing which bearing corner will clear. ²⁾ For thrust rating multiply C by 1.32 and C₀ by 2.94.
³⁾ Listed values are for machined bronze cage, ABEC-1. The values have been determined through historical application and practice. For a more complete explanation, see page 276.
⁴⁾ Rating for one million revolutions or 500 hours at 33 1/3 RPM.

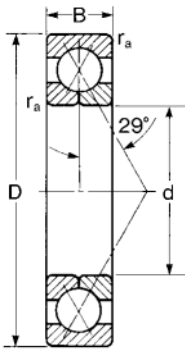

For duplex sets of 7000 and 9000 series bearings see page 239.

MRC Bearing Number	Bore d		Outside Diameter D		Width B		Fillet Radius ¹⁾ r _a		Basic Radial Load Rating ²⁾				Speed Rating ³⁾	
									Dynamic C ⁴⁾		Static C ₀		Grease RPM	Oil RPM
									N	lbf	N	lbf		
9302-U	15	.5906	42	1.6535	13	.5118	1.0	.04	9 950	2 240	6 100	1 370	16 000	21 000
9303-U	17	.6693	47	1.8504	14	.5512	1.0	.04	12 100	2 720	7 500	1 690	15 000	19 000
9304-U	20	.7874	52	2.0472	15	.5906	1.0	.04	18 600	4 180	10 600	2 380	13 000	17 000
9305-U	25	.9843	62	2.4409	17	.6693	1.0	.04	21 200	4 770	13 700	3 080	11 000	14 000
9306-U	30	1.1811	72	2.8346	19	.7480	1.0	.04	28 100	6 320	18 600	4 180	9 200	12 000
9307-U	35	1.3780	80	3.1496	21	.8268	1.5	.06	35 800	8 050	24 000	5 400	8 500	11 000
9308-U	40	1.5748	90	3.5433	23	.9055	1.5	.06	44 200	9 940	31 000	7 000	7 300	9 500
9309-U	45	1.7717	100	3.9370	25	.9843	1.5	.06	52 700	11 800	38 000	8 540	6 400	8 300
9310-U	50	1.9685	110	4.3307	27	1.0630	2.0	.08	68 900	15 500	49 000	11 000	5 800	7 500
9311-U	55	2.1654	120	4.7244	29	1.1417	2.0	.08	80 600	18 100	57 000	12 800	5 100	6 600
9312-U	60	2.3622	130	5.1181	31	1.2205	2.0	.08	92 300	20 700	65 500	14 700	4 900	6 400
9313-U	65	2.5591	140	5.5118	33	1.2992	2.0	.08	97 500	21 900	75 000	16 900	4 600	6 000
9314-U	70	2.7559	150	5.9055	35	1.3780	2.0	.08	111 000	25 000	85 000	19 100	4 100	5 300
9315-U	75	2.9528	160	6.2992	37	1.4567	2.0	.08	130 000	29 200	106 000	23 800	3 900	5 000
9316-U	80	3.1496	170	6.6929	39	1.5354	2.0	.08	143 000	32 100	120 000	27 000	3 600	4 700
9317-U	85	3.3465	180	7.0866	41	1.6142	2.5	.10	153 000	34 400	134 000	30 100	3 500	4 500
9318-U	90	3.5433	190	7.4803	43	1.6929	2.5	.10	168 000	37 800	150 000	33 700	3 200	4 200
9319-U	95	3.7402	200	7.8740	45	1.7717	2.5	.10	178 000	40 000	166 000	37 300	3 100	4 000
9320-U	100	3.9370	215	8.4646	47	1.8504	2.5	.10	190 000	42 700	183 000	41 100	3 000	3 900
9321-U	105	4.1339	225	8.8583	49	1.9291	2.5	.10	203 000	45 600	200 000	45 000	2 900	3 800
9322-U	110	4.3307	240	9.4488	50	1.9685	2.5	.10	229 000	51 500	236 000	53 100	2 700	3 500

1) Fillet radius indicates maximum fillet radius on shaft or in housing which bearing corner will clear.

2) For thrust rating multiply C by 1.32 and C₀ by 2.94.

3) Listed values are for machined bronze cage, ABEC-1.

The values have been determined through historical application and practice. For a more complete explanation, see page 276.

4) Rating for one million revolutions or 500 hours at 33⅓ RPM.

NOTES

9000-U Series
Split Inner Ring
29 Degree Angular
Contact Ball Bearings
Single Bearing

Dynamic and static equivalent radial load
and life rating

Dynamic equivalent radial load

$$P = F_R \quad \text{when } F_A/F_R \leq 0.80$$

or

$$P = 0.39 F_R + 0.76 F_A \quad \text{when } F_A/F_R > 0.80$$

P = Dynamic equivalent radial load

F_R = Radial load

F_A = Thrust load

Consult MRC Bearing Services when

F_R/F_A > 1.0

Static equivalent radial load

$$P_0 = 0.50 F_R + 0.34 F_A$$

P₀ is always $\geq F_R$

P₀ = Static equivalent radial load

F_R = Radial load

F_A = Thrust load

Life rating

$$L_{10} = \left(\frac{C}{P}\right)^3 \quad (\text{millions of revolutions})$$

or

$$L_{10h} = \frac{10^6}{60n} \left(\frac{C}{P}\right)^3 \quad (\text{Hours})$$

C = Basic dynamic radial load rating
(from single bearing tables)

P = Dynamic equivalent radial load

n = Speed in rpm

9000-U Series

Split Inner Ring

29 Degree Angular

Contact Ball Bearings

Single Bearing

Dynamic equivalent radial load and life calculation examples

Bearing size: 9309 U

Speed: 2000 RPM

Basic dynamic radial load rating (C) = 11800

Case 1

Radial load (F_R) = 1750

Thrust load (F_A) = 1310

Equivalent load (P) = F_R or $0.39 F_R + 0.76 F_A$

$F_A/F_R = 1310/1750 = 0.75$

Since $F_A/F_R < 0.80$, $P = F_R = 1750$

$$\text{Life (L10)} = \left(\frac{C}{P}\right)^3 = \left(\frac{11800}{1750}\right)^3 = 307 \times 10^6 \text{ Rev.}$$

or

$$\begin{aligned} \text{Life (L10h)} &= \frac{10^6}{60n} \left(\frac{C}{P}\right)^3 = \frac{10^6}{60 \times 2000} \left(\frac{11800}{1750}\right)^3 \\ &= 2558 \text{ Hrs} \end{aligned}$$

Case 2

Radial load (F_R) = 1750

Thrust load (F_A) = 2100

Equivalent load (P) = F_R or $0.39 F_R + 0.76 F_A$

$F_A/F_R = 2100/1750 = 1.20$

Since $F_A/F_R > 0.80$, $P = 0.39 \times 1750 + 0.76 \times 2100 = 2279$

$$\text{Life (L10)} = \left(\frac{C}{P}\right)^3 = \left(\frac{11800}{2279}\right)^3 = 139 \times 10^6 \text{ Rev.}$$

or

$$\begin{aligned} \text{Life (L10h)} &= \frac{10^6}{60n} \left(\frac{C}{P}\right)^3 = \frac{10^6}{60 \times 2000} \left(\frac{11800}{2279}\right)^3 \\ &= 1158 \text{ Hrs} \end{aligned}$$

Case 3

Thrust load (F_A) = 2100

Equivalent load (P) = $0.39 F_R + 0.76 F_A$

$F_A/F_R = 2100/0 = \infty$

Since $F_A/F_R > 0.80$, $P = 0.76 \times 2100 = 1596$

$$\text{Life (L10)} = \left(\frac{C}{P}\right)^3 = \left(\frac{11800}{1596}\right)^3 = 404 \times 10^6 \text{ Rev.}$$

or

$$\begin{aligned} \text{Life (L10h)} &= \frac{10^6}{60n} \left(\frac{C}{P}\right)^3 = \frac{10^6}{60 \times 2000} \left(\frac{11800}{1596}\right)^3 \\ &= 3367 \text{ Hrs} \end{aligned}$$

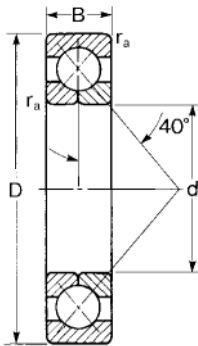

For duplex sets of 7000 and 9000 series bearings see page 239.

MRC Bearing Number	Bore		Outside Diameter D		Width B		Fillet Radius ¹⁾ r _a		Basic Radial Load Rating ²⁾				Speed Rating ³⁾		
									Dynamic C ⁴⁾		Static C ₀		Grease	Oil	
	d	mm	in	mm	in	mm	in	mm	in	N	lbf	N	lbf	RPM	RPM
9202-UP	15	.5906	35	1.3780	11	.4331	.64	.025	8 840	1 990	4 250	955	17 000	24 000	
9203-UP	17	.6693	40	1.5748	12	.4724	.64	.025	11 700	2 630	6 000	1 350	15 000	20 000	
9204-UP	20	.7874	47	1.8504	14	.5512	1.0	.04	14 800	3 330	8 300	1 870	12 000	17 000	
9205-UP	25	.9843	52	2.0472	15	.5906	1.0	.04	16 800	3 780	10 400	2 340	10 000	15 000	
9206-UP	30	1.1811	62	2.4409	16	.6299	1.0	.04	21 200	4 770	12 700	2 860	8 500	12 000	
9207-UP	35	1.3780	72	2.8346	17	.6693	1.0	.04	29 100	6 540	19 300	4 340	8 000	11 000	
9208-UP	40	1.5748	80	3.1496	18	.7087	1.0	.04	32 500	7 310	22 400	5 040	7 000	9 500	
9209-UP	45	1.7717	85	3.3465	19	.7480	1.0	.04	39 000	8 770	27 500	6 180	6 700	9 000	
9210-UP	50	1.9685	90	3.5433	20	.7874	1.0	.04	40 300	9 060	30 000	6 740	6 000	8 000	
9211-UP	55	2.1654	100	3.9370	21	.8268	1.5	.06	48 800	11 000	37 500	8 430	5 600	7 500	
9212-UP	60	2.3622	110	4.3307	22	.8661	1.5	.06	58 500	13 200	45 500	10 200	5 000	6 700	
9213-UP	65	2.5591	120	4.7244	23	.9055	1.5	.06	63 700	14 300	51 000	11 500	4 500	6 000	
9214-UP	70	2.7559	125	4.9213	24	.9449	1.5	.06	68 900	15 500	56 000	12 600	4 300	5 600	
9215-UP	75	2.9528	130	5.1181	25	.9843	1.5	.06	71 500	16 100	60 000	13 500	4 000	5 300	
9216-UP	80	3.1496	140	5.5118	26	1.0236	1.5	.06	83 200	18 700	71 000	16 000	3 800	5 000	
9217-UP	85	3.3465	150	5.9055	28	1.1024	2.0	.08	95 600	21 500	83 000	18 700	3 600	4 800	
9218-UP	90	3.5433	160	6.2992	30	1.1811	2.0	.08	108 000	24 300	95 000	21 400	3 400	4 500	
9219-UP	95	3.7402	170	6.6929	32	1.2598	2.0	.08	124 000	27 900	110 000	24 700	3 200	4 300	
9220-UP	100	3.9370	180	7.0866	34	1.3386	2.0	.08	130 000	29 200	125 000	28 100	3 000	4 000	
9221-UP	105	4.1339	190	7.4803	36	1.4173	2.0	.08	143 000	32 100	129 000	29 000	2 800	3 800	
9222-UP	110	4.3307	200	7.8740	38	1.4961	2.0	.08	153 000	34 400	156 000	35 100	2 600	3 600	
9300-UP															
9302-UP	15	.5906	42	1.6535	13	.5118	1.0	.04	12 700	2 860	6 100	1 370	15 000	20 000	
9303-UP	17	.6693	47	1.8504	14	.5512	1.0	.04	16 800	3 780	8 500	1 910	13 000	18 000	
9304-UP	20	.7874	52	2.0472	15	.5906	1.0	.04	18 600	4 180	9 500	2 140	11 000	16 000	
9305-UP	25	.9843	62	2.4409	17	.6693	1.0	.04	24 200	5 440	13 400	3 150	9 000	13 000	
9306-UP	30	1.1811	72	2.8346	19	.7480	1.0	.04	32 500	7 310	19 600	4 410	8 000	11 000	
9307-UP	35	1.3780	80	3.1496	21	.8268	1.5	.06	39 700	8 920	24 500	5 510	7 500	10 000	
9308-UP	40	1.5748	90	3.5433	23	.9055	1.5	.06	47 500	10 700	30 500	6 860	6 700	9 000	
9309-UP	45	1.7717	100	3.9370	25	.9843	1.5	.06	59 200	13 300	40 000	8 990	6 000	8 000	
9310-UP	50	1.9685	110	4.3307	27	1.0630	2.0	.08	68 900	15 500	52 000	11 700	5 300	7 000	
9311-UP	55	2.1654	120	4.7244	29	1.1417	2.0	.08	79 300	17 800	56 000	12 600	4 800	6 300	
9312-UP	60	2.3622	130	5.1181	31	1.2205	2.0	.08	90 400	20 300	64 000	14 400	4 500	6 000	
9313-UP	65	2.5591	140	5.5118	33	1.2992	2.0	.08	101 000	22 700	80 000	18 000	4 300	5 600	
9314-UP	70	2.7559	150	5.9055	35	1.3780	2.0	.08	117 000	26 300	93 000	20 900	3 800	5 000	
9315-UP	75	2.9528	160	6.2992	37	1.4567	2.0	.08	127 000	28 600	100 000	22 500	3 600	4 800	
9316-UP	80	3.1496	170	6.6929	39	1.5354	2.0	.08	138 000	31 000	110 000	24 700	3 400	4 500	
9317-UP	85	3.3465	180	7.0866	41	1.6142	2.5	.10	148 000	33 300	122 000	27 400	3 200	4 300	
9318-UP	90	3.5433	190	7.4803	43	1.6929	2.5	.10	159 000	35 700	137 000	30 800	3 000	4 000	
9319-UP	95	3.7402	200	7.8740	45	1.7717	2.5	.10	168 000	37 800	150 000	33 700	2 800	3 800	
9320-UP	100	3.9370	215	8.4646	47	1.8504	2.5	.10	190 000	42 700	190 000	42 700	2 600	3 600	
9321-UP	105	4.1339	225	8.8583	49	1.9291	2.5	.10	203 000	45 600	196 000	44 100	2 400	3 400	
9322-UP	110	4.3307	240	9.4488	50	1.9685	2.5	.10	212 000	47 700	228 000	51 300	2 200	3 200	

¹⁾ Fillet radius indicates maximum fillet radius on shaft or in housing which bearing corner will clear.

²⁾ For thrust rating multiply C by 1.75 and C₀ by 3.85.

³⁾ Listed values are for machined bronze cage, ABEC-1.

The values have been determined through historical application and practice. For a more complete explanation, see page 276.

⁴⁾ Rating for one million revolutions or 500 hours at 33 1/3 RPM.

9000-UP Series Split Inner Ring 40 Degree Angular Contact Ball Bearings Single Bearing

Dynamic and static equivalent radial load and life rating

Dynamic equivalent radial load

$$P = F_R \quad \text{when } F_A/F_R \leq 1.14$$

or

$$P = 0.35 F_R + 0.57 F_A \quad \text{when } F_A/F_R > 1.14$$

P = Dynamic equivalent radial load

F_R = Radial load

F_A = Thrust load

Consult MRC Bearing Services when

$$F_R/F_A > 1.0$$

Static equivalent radial load

$$P_0 = 0.5 F_R + 0.26 F_A$$

P_0 is always $\geq F_R$

P_0 = Static equivalent radial load

F_R = Radial load

F_A = Thrust load

Life rating

$$L_{10} = \left(\frac{C}{P}\right)^3 \quad (\text{millions of revolutions})$$

or

$$L_{10h} = \frac{10^6}{60n} \left(\frac{C}{P}\right)^3 \quad (\text{Hours})$$

C = Basic dynamic radial load rating
(from single-row bearing tables)

P = Dynamic equivalent radial load

n = Speed in rpm

**Dynamic equivalent radial load
and life calculation examples**

Bearing size: 9309 UP

Speed: 2000 RPM

Basic dynamic radial load rating (C) = 13300

Case 1Radial load (F_R) = 1750Thrust load (F_A) = 1960 $F_A/F_R = 1960/1750 = 1.12$ Since $F_A/F_R < 1.14$, equivalent load (P) = $F_R = 1750$

$$\text{Life (L}_{10}\text{)} = \left(\frac{C}{P}\right)^3 = \left(\frac{13300}{1750}\right)^3 = 439 \times 10^6 \text{ Rev.}$$

or

$$\begin{aligned} \text{Life (L}_{10}\text{h)} &= \frac{10^6}{60n} \left(\frac{C}{P}\right)^3 = \frac{10^6}{60 \times 2000} \left(\frac{13300}{1750}\right)^3 \\ &= 3658 \text{ Hrs} \end{aligned}$$

Case 2Radial load (F_R) = 1750Thrust load (F_A) = 2450 $F_A/F_R = 2450/1750 = 1.40$ Since $F_A/F_R > 1.14$, equivalent load (P) = $0.35 F_R + 0.57 F_A$ $P = 0.35 \times 1750 + 0.57 \times 2450 = 2009$

$$\text{Life (L}_{10}\text{)} = \left(\frac{C}{P}\right)^3 = \left(\frac{13300}{2009}\right)^3 = 290 \times 10^6 \text{ Rev.}$$

or

$$\begin{aligned} \text{Life (L}_{10}\text{h)} &= \frac{10^6}{60n} \left(\frac{C}{P}\right)^3 = \frac{10^6}{60 \times 2000} \left(\frac{13300}{2009}\right)^3 \\ &= 2417 \text{ Hrs} \end{aligned}$$

Case 3Thrust load (F_A) = 2450 $F_A/F_R = 2450/0 = \infty$ Since $F_A/F_R > 1.14$, equivalent load (P) = $0.35 F_R + 0.57 F_A$ $P = 0.57 \times 2450 = 1397$

$$\text{Life (L}_{10}\text{)} = \left(\frac{C}{P}\right)^3 = \left(\frac{13300}{1397}\right)^3 = 863 \times 10^6 \text{ Rev.}$$

or

$$\begin{aligned} \text{Life (L}_{10}\text{h)} &= \frac{10^6}{60n} \left(\frac{C}{P}\right)^3 = \frac{10^6}{60 \times 2000} \left(\frac{13300}{1397}\right)^3 \\ &= 7192 \text{ Hrs} \end{aligned}$$

NOTES

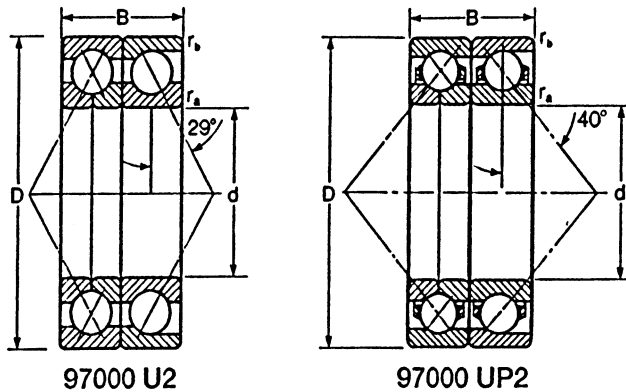

97000U and 97000H Series

The 97000U Series consists of a matched set of 9000UDT and 7000DT flush ground bearings having a 29° contact angle. The 97000H Series consists of a matched set of 9000HDT (split outer ring) and 7000DT flush ground bearings.

97000UP and 97000HP Series

The 97000UP Series consists of a matched set of 9000 UPDT and 7000PDT flush ground bearings having a 40° contact angle. The 97000HP Series consist of a matched set of 9000HPDT (split outer ring) and 7000PDT flush ground bearings.

Typical Mountings

The bearings are usually mounted in pairs. This arrangement divides the thrust load in one direction while accommodating reversing thrust load. To increase thrust capacity in one direction it is possible to mount additional bearings in tandem.

Cage Types and Materials

Furnished in one-piece machined bronze riding ground O.D. of inner ring.

Size	Series	Page
97200 U2	Light—29 Degree Contact Angle	130
97300 U2	Medium—29 Degree Contact Angle	131
97200 UP2	Light—40 Degree Contact Angle	132
97300 UP2	Medium—40 Degree Contact Angle	133
97000 U	Equivalent Load and Life	134
97000 U	Life Calculation Examples	135
97000 UP	Equivalent Load and Life	136
97000 UP	Life Calculation Examples	137

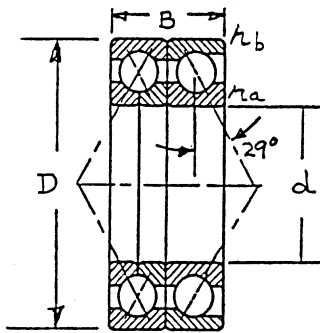

This series consists of a matched set of 9200UDT and 7200DT flush ground bearings having a 29° contact angle. One-piece, land guided, machined brass cages are standard for this series.

These bearings are mounted in pairs in applications where substantial thrust loads are present. This arrangement divides the thrust load in one direction while accommodating reversing thrust load. To increase thrust capacity in one direction additional bearings may be mounted in tandem.

For proper mounting orientation refer to page 239

MRC Bearing Number	Bore		Outside Diameter D		Width B		Fillet Radius ¹⁾				Basic Radial Load Rating ²⁾				Speed Rating ³⁾	
											Dynamic C _d		Static C ₀		Grease	Oil
	d	mm	in	mm	in	mm	in	mm	in	mm	in	N	lbf	N	lbf	RPM
97207U2	35	1.3780	72	2.8346	34	1.3386	1.0	.04	.60	.024	37 770	8 480	34 000	7 640	7 400	9 600
97208U2	40	1.5748	80	3.1496	36	1.4173	1.0	.04	.60	.024	49 400	11 100	45 500	10 200	6 200	8 000
97209U2	45	1.7717	85	3.3465	38	1.4961	1.0	.04	.60	.024	49 400	11 100	46 500	10 500	5 800	7 600
97210U2	50	1.9685	90	3.5433	40	1.5748	1.0	.04	.60	.024	54 000	12 100	54 000	12 100	5 100	6 600
97211U2	55	2.1654	100	3.9370	42	1.6535	1.5	.060	1.0	.040	79 300	17 800	75 000	16 900	4 800	6 200
97212U2	60	2.3622	110	4.3307	44	1.7323	1.5	.060	1.0	.040	85 200	19 100	88 000	19 800	4 300	5 600
97213U2	65	2.5591	120	4.7244	46	1.8110	1.5	.060	1.0	.040	104 000	23 400	110 000	24 700	3 900	5 100
97214U2	70	2.7559	125	4.9213	48	1.8898	1.5	.060	1.0	.040	104 000	23 400	110 000	24 700	3 700	4 800
97215U2	75	2.9528	130	5.1181	50	1.9685	1.5	.060	1.0	.040	130 000	29 200	140 000	31 500	3 400	4 500
97216U2	80	3.1496	140	5.5118	52	2.0472	2.0	.080	1.0	.040	121 000	27 200	134 000	30 100	3 300	4 200
97217U2	85	3.3465	150	5.9055	56	2.2047	2.0	.080	1.0	.040	148 000	33 300	166 000	37 300	3 000	3 900
97218U2	90	3.5433	160	6.2992	60	2.3622	2.0	.080	1.0	.040	190 000	42 700	236 000	53 100	2 900	3 800
97219U2	95	3.7402	170	6.6929	64	2.5197	2.0	.080	1.0	.040	199 000	44 700	228 000	51 300	2 800	3 600
97220U2	100	3.9370	180	7.0866	68	2.6772	2.0	.080	1.0	.040	225 000	50 600	260 000	58 500	2 600	3 300
97221U2	105	4.1339	190	7.4803	72	2.8346	2.0	.080	1.0	.040	242 000	54 400	295 000	66 300	2 400	3 100
97222U2	110	4.3307	200	7.8740	76	2.9921	2.0	.080	1.0	.040	265 000	59 600	310 000	69 700	2 300	3 000
97224U2	120	4.7244	215	8.4646	80	3.1496	2.0	.080	1.0	.040	281 000	63 200	355 000	79 800	2 200	2 800
97226U2	130	5.1181	230	9.0551	80	3.1496	2.5	.10	1.0	.040	319 000	71 700	415 000	93 300	2 000	2 600
97228U2	140	5.5118	250	9.8425	84	3.3071	2.5	.10	1.0	.040	338 000	76 000	465 000	105 000	1 800	2 400
97230U2	150	5.9055	270	10.6299	90	3.5435	2.5	.10	1.0	.040	397 000	89 200	560 000	126 000	1 700	2 200
97232U2	160	6.2992	290	11.4173	96	3.7795	2.5	.10	1.0	.040	442 000	99 400	670 000	135 000	1 600	2 100
97234U2	170	6.6929	310	12.2047	104	4.0945	3.0	.12	1.0	.040	468 000	105 000	735 000	165 000	1 500	2 000
97236U2	180	7.0866	320	12.5984	104	4.0945	3.0	.12	1.0	.040	494 000	111 000	780 000	175 000	1 500	1 900

¹⁾ Fillet radius indicates maximum fillet radius on shaft or in housing which bearing corner will clear.

²⁾ For thrust rating multiply C by 1.32 and C₀ by 2.94.

³⁾ Listed values are for machined brass cage.

Values have been determined through historical application and practice.

⁴⁾ Rating for one million revolutions or 500 hours at 33 1/3 rpm.

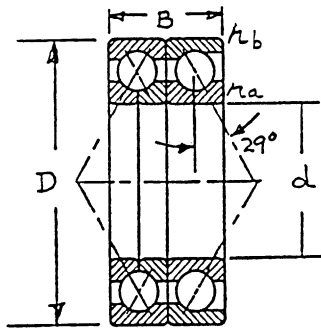

This series consists of a matched set and 9300UDT and 7300DT flush ground bearings having a 29° contact angle. One-piece, land guided, machined brass cages are standard for this series.

These bearings are mounted in pairs in applications where substantial thrust loads are present. This arrangement divides the thrust load in one direction while accommodating reversing thrust load. To increase thrust capacity in one direction additional bearings may be mounted in tandem.

For proper mounting orientation refer to page 239

MRC Bearing Number	Bore		Outside Diameter D		Width B		Fillet Radius ¹⁾				Basic Radial Load Rating ²⁾				Speed Rating ³⁾	
											Dynamic C _d		Static C ₀		Grease	Oil
	d	mm	in	mm	in	mm	in	mm	in	mm	in	N	lbf	N	lbf	RPM
97307U2	35	1.3780	80	3.1496	42	1.6535	1.5	.06	1.0	.040	58 500	13 200	48 000	10 800	6 800	8 800
97308U2	40	1.5748	90	3.5433	46	1.8110	1.5	.06	1.0	.040	71 500	16 100	61 500	13 700	5 800	7 600
97309U2	45	1.7717	100	3.9370	50	1.9685	1.5	.06	1.0	.040	85 200	19 200	75 000	16 900	5 100	6 600
97310U2	50	1.9685	110	4.3307	54	2.1260	2.0	.08	1.0	.040	121 000	27 200	106 000	23 800	4 600	6 000
97311U2	55	2.1654	120	4.7244	58	2.2835	2.0	.08	1.0	.040	140 000	31 500	125 000	28 100	4 100	5 300
97312U2	60	2.3622	130	5.1181	62	2.4409	2.0	.08	1.0	.040	159 000	35 700	146 000	32 800	3 900	5 100
97313U2	65	2.5591	140	5.5118	65	2.5984	2.0	.08	1.0	.040	178 000	40 000	173 000	38 900	3 700	4 800
97314U2	70	2.7559	150	5.9055	70	2.7559	2.0	.08	1.0	.040	182 000	40 900	170 000	38 200	3 300	4 200
97315U2	75	2.9528	160	6.2992	74	2.9134	2.0	.08	1.0	.040	225 000	50 600	228 000	51 300	3 100	4 000
97316U2	80	3.1496	170	6.6929	78	3.0709	2.0	.08	1.0	.040	234 000	52 600	240 000	54 000	2 900	3 800
97317U2	85	3.3465	180	7.0866	82	3.2283	2.5	.10	1.0	.040	265 000	59 600	285 000	64 100	2 800	3 600
97318U2	90	3.5433	190	7.4803	86	3.3858	2.5	.10	1.0	.040	276 000	62 000	300 000	67 400	2 600	3 400
97319U2	95	3.7402	200	7.8740	90	3.5433	2.5	.10	1.0	.040	291 000	65 400	325 000	73 100	2 500	3 200
97320U2	100	3.9370	215	8.4646	94	3.7008	2.5	.10	1.0	.040	312 000	70 100	365 000	82 100	2 400	3 100
97321U2	105	4.1339	225	8.8583	98	3.8583	2.5	.10	1.0	.040	332 000	74 600	400 000	89 900	2 300	3 000
97322U2	110	4.3307	240	9.4488	100	3.9370	2.5	.10	1.0	.040	371 000	83 400	475 000	107 000	2 200	2 800
97324U2	120	4.7244	260	10.2362	110	4.3307	2.5	.10	1.0	.040	423 000	95 100	560 000	126 000	2 000	2 600
97326U2	130	5.1181	280	11.0236	116	4.5669	3.0	.12	1.0	.040	468 000	105 000	640 000	144 000	1 800	2 400
97328U2	140	5.5118	300	11.8110	124	4.8819	3.0	.12	1.0	.040	507 000	114 000	735 000	165 000	1 800	2 200
97330U2	150	5.9055	320	12.5984	130	5.1181	3.0	.12	1.0	.040	559 000	126 000	865 000	194 000	1 600	2 100
97332U2	160	6.2992	340	13.3858	136	5.3543	3.0	.12	1.0	.040	616 000	139 000	965 000	217 000	1 500	2 000
97334U2	170	6.6929	360	14.1732	144	5.6693	3.0	.12	1.0	.040	650 000	146 000	1 040 000	234 000	1 500	1 900
97336U2	180	7.0866	380	14.9606	150	5.9055	3.0	.12	1.0	.040	689 000	155 000	1 160 000	261 000	1 400	1 800

¹⁾ Fillet radius indicates maximum fillet radius on shaft or in housing which bearing corner will clear.

²⁾ For thrust rating multiply C by 1.32 and C₀ by 2.94.

³⁾ Listed values are for machined brass cage.

Values have been determined through historical application and practice.

⁴⁾ Rating for one million revolutions or 500 hours at 33 1/3 rpm.

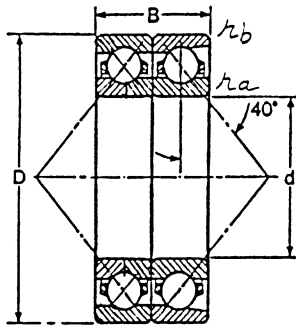

This series consists of a matched set of 9200UPDT and 7200PDT flush ground bearings having a 40° contact angle. One-piece, land guided, machined brass cages are standard for this series.

These bearings are mounted in pairs in applications where substantial thrust loads are present. This arrangement divides the thrust load in one direction while accommodating reversing thrust load. To increase thrust capacity in one direction additional bearings may be mounted in tandem.

For proper mounting orientation refer to page 239

MRC Bearing Number	Bore		Outside Diameter D		Width B		Fillet Radius ¹⁾				Basic Radial Load Rating ²⁾				Speed Rating ³⁾	
	d mm	in	mm	in	mm	in	r _a		r _b		Dynamic C _d ⁴⁾		Static C ₀		Grease RPM	Oil RPM
							mm	in	mm	in	N	lbf	N	lbf		
97207UP2	35	1.3780	72	2.8346	34	1.3386	1.0	.040	.60	.024	47 500	10 700	39 000	8 770	6 300	8 500
97208UP2	40	1.5748	80	3.1496	36	1.4173	1.0	.040	.60	.024	52 700	11 800	45 000	10 100	5 600	7 500
97209UP2	45	1.7717	85	3.3465	38	1.4961	1.0	.040	.60	.024	62 400	14 000	55 000	12 400	5 300	7 000
97210UP2	50	1.9685	90	3.5433	40	1.5748	1.0	.040	.60	.024	65 000	14 600	60 000	13 500	4 800	6 300
97211UP2	55	2.1654	100	3.9370	42	1.6535	1.5	.060	1.0	.040	79 300	17 800	75 000	16 900	4 500	6 000
97212UP2	60	2.3622	110	4.3307	44	1.7323	1.5	.060	1.0	.040	95 600	21 500	91 600	20 600	4 000	5 300
97213UP2	65	2.5591	120	4.7244	46	1.8110	1.5	.060	1.0	.040	104 000	23 400	100 000	22 500	3 600	4 800
97214UP2	70	2.7559	125	4.9213	48	1.8898	1.5	.060	1.0	.040	112 000	25 200	112 000	25 200	3 400	4 500
97215UP2	75	2.9528	130	5.1181	50	1.9685	1.5	.060	1.0	.040	117 000	26 300	120 000	27 000	3 200	4 300
97216UP2	80	3.1496	140	5.5118	52	2.0472	2.0	.080	1.0	.040	135 000	30 300	140 000	31 500	3 000	4 000
97217UP2	85	3.3465	150	5.9055	56	2.2047	2.0	.080	1.0	.040	156 000	35 100	166 000	37 300	2 800	3 800
97218UP2	90	3.5433	160	6.2992	60	2.3622	2.0	.080	1.0	.040	178 000	40 000	190 000	42 700	2 600	3 600
97219UP2	95	3.7402	170	6.6929	64	2.5197	2.0	.080	1.0	.040	199 000	44 700	220 000	49 500	2 400	3 400
97220UP2	100	3.9370	180	7.0866	68	2.6772	2.0	.080	1.0	.040	212 000	47 700	250 000	56 200	2 200	3 200
97221UP2	105	4.1339	190	7.4803	72	2.8346	2.0	.080	1.0	.040	229 000	51 500	260 000	58 500	2 000	3 000
97222UP2	110	4.3307	200	7.8740	76	2.9921	2.0	.080	1.0	.040	251 000	56 400	310 000	69 700	1 900	2 800
97224UP2	120	4.7244	215	8.4646	80	3.1496	2.0	.080	1.0	.040	270 000	60 700	325 000	73 100	1 700	2 400
97226UP2	130	5.1181	230	9.0551	80	3.1496	2.5	.10	1.0	.040	302 000	67 900	390 000	87 700	1 700	2 400
97228UP2	140	5.5118	250	9.8425	84	3.3071	2.5	.10	1.0	.040	319 000	71 700	430 000	96 700	1 600	2 200
97230UP2	150	5.9055	270	10.6299	90	3.5435	2.5	.10	1.0	.040	351 000	78 900	520 000	117 000	1 500	2 000
97232UP2	160	6.2992	290	11.4173	96	3.7795	2.5	.10	1.0	.040	390 000	87 700	560 000	126 000	1 300	1 700
97234UP2	170	6.6929	310	12.2047	104	4.0945	3.0	.12	1.0	.040	436 000	98 000	655 000	147 000	1 200	1 500
97236UP2	180	7.0866	320	12.5984	104	4.0945	3.0	.12	1.0	.040	449 000	101 000	710 000	160 000	1 100	1 500

¹⁾ Fillet radius indicates maximum fillet radius on shaft or in housing which bearing corner will clear.

²⁾ For thrust rating multiply C by 1.76 and C₀ by 3.86.

³⁾ Listed values are for machined brass cage.

Values have been determined through historical application and practice.

⁴⁾ Rating for one million revolutions or 500 hours at 33 1/3 rpm.

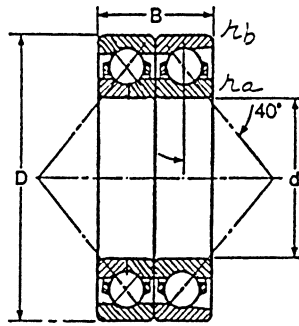

This series consists of a matched set of 9300UPDT and 7300PDT flush ground bearings having a 40° contact angle. One-piece, land guided, machined brass cages are standard for this series.

These bearings are mounted in pairs in applications where substantial thrust loads are present. This arrangement divides the thrust load in one direction while accommodating reversing thrust load. To increase thrust capacity in one direction additional bearings may be mounted in tandem.

For proper mounting orientation refer to page 239

MRC Bearing Number	Bore		Outside Diameter D		Width B		Fillet Radius ¹⁾				Basic Radial Load Rating ²⁾				Speed Rating ³⁾	
	d mm	in	mm	in	mm	in	ra		rb		Dynamic C _d ⁴⁾		Static C ₀		Grease RPM	Oil RPM
							mm	in	mm	in	N	lbf	N	lbf		
97307UP2	35	1.3780	80	3.1496	42	1.6535	1.5	.06	1.0	.040	63 700	14 300	49 000	11 000	6 000	8 000
97308UP2	40	1.5748	90	3.5433	46	1.8110	1.5	.06	1.0	.040	76 100	17 100	61 000	13 700	5 300	7 000
97309UP2	45	1.7717	100	3.9370	50	1.9685	1.5	.06	1.0	.040	97 500	21 900	80 000	18 000	4 800	6 300
97310UP2	50	1.9685	110	4.3307	54	2.1260	2.0	.08	1.0	.040	112 000	25 200	104 000	23 400	4 300	5 600
97311UP2	55	2.1654	120	4.7244	58	2.2835	2.0	.08	1.0	.040	130 000	29 200	112 000	25 200	3 800	5 000
97312UP2	60	2.3622	130	5.1181	62	2.4409	2.0	.08	1.0	.040	148 000	33 300	129 000	29 000	3 600	4 800
97313UP2	65	2.5591	140	5.5118	65	2.5984	2.0	.08	1.0	.040	165 000	37 100	160 000	36 000	3 200	4 300
97314UP2	70	2.7559	150	5.9055	70	2.7559	2.0	.08	1.0	.040	190 000	42 700	186 000	41 800	3 000	4 000
97315UP2	75	2.9528	160	6.2992	74	2.9134	2.0	.08	1.0	.040	208 000	46 800	200 000	45 000	2 800	3 800
97316UP2	80	3.1496	170	6.6929	78	3.0709	2.0	.08	1.0	.040	225 000	50 600	220 000	49 500	2 600	3 600
97317UP2	85	3.3465	180	7.0866	82	3.2283	2.5	.10	1.0	.040	238 000	53 500	245 000	55 100	2 400	3 400
97318UP2	90	3.5433	190	7.4803	86	3.3858	2.5	.10	1.0	.040	255 000	57 300	270 000	60 700	2 200	3 200
97319UP2	95	3.7402	200	7.8740	90	3.5433	2.5	.10	1.0	.040	276 000	62 000	300 000	67 400	2 000	3 000
97320UP2	100	3.9370	215	8.4646	94	3.7008	2.5	.10	1.0	.040	307 000	69 000	380 000	85 400	1 900	2 800
97321UP2	105	4.1339	225	8.8583	98	3.8583	2.5	.10	1.0	.040	325 000	73 100	390 000	87 700	1 800	2 600
97322UP2	110	4.3307	240	9.4488	100	3.9370	2.5	.10	1.0	.040	345 000	77 600	455 000	102 000	1 700	2 400
97324UP2	120	4.7244	260	10.2362	110	4.3307	2.5	.10	1.0	.040	390 000	87 700	530 000	119 000	1 600	2 200
97326UP2	130	5.1181	280	11.0236	116	4.5669	3.0	.12	1.0	.040	449 000	101 000	610 000	137 000	1 500	2 000
97328UP2	140	5.5118	300	11.8110	124	4.8819	3.0	.12	1.0	.040	488 000	110 000	695 000	156 000	1 400	1 900
97330UP2	150	5.9055	320	12.5984	130	5.1181	3.0	.12	1.0	.040	540 000	121 000	780 000	175 000	1 200	1 700
97332UP2	160	6.2992	340	13.3858	136	5.3543	3.0	.12	1.0	.040	553 000	124 000	850 000	191 000	1 200	1 600
97334UP2	170	6.6929	360	14.1732	144	5.6693	3.0	.12	1.0	.040	605 000	136 000	965 000	217 000	1 000	1 500
97336UP2	180	7.0866	380	14.9606	150	5.9055	3.0	.12	1.0	.040	650 000	146 000	1 100 000	247 000	950	1 400

¹⁾ Fillet radius indicates maximum fillet radius on shaft or in housing which bearing corner will clear.

²⁾ For thrust rating multiply C by 1.76 and C₀ by 3.86.

³⁾ Listed values are for machined brass cage.

Values have been determined through historical application and practice.

⁴⁾ Rating for one million revolutions or 500 hours at 33 1/3 rpm.

*Duplex 97000 U2 Series
29 Degree Angular Contact
Bearings*

*Dynamic and static equivalent load
and life rating*

Dynamic equivalent radial load

$$P = 1.0 F_R \quad \text{when } \frac{F_A}{F_R} \leq 0.80$$

$$P = 0.39 F_R + 0.76 F_A \quad \text{when } \frac{F_A}{F_R} > 0.80$$

P = Dynamic equivalent radial load
F_R = Radial load
F_A = Thrust load

Static equivalent radial load

$$P_0 = 1.0 F_R + 0.66 F_A$$

P₀ is always $\geq F_R$

P₀ = Static equivalent radial load
F_R = Radial load
F_A = Thrust load

Life rating

$$L_{10} = \left(\frac{C}{P}\right)^3 \quad (\text{millions of revolutions})$$

or

$$L_{10h} = \frac{10^6}{60n} \left(\frac{C}{P}\right)^3 \quad (\text{Hours})$$

C = Dynamic radial load rating
P = Dynamic equivalent radial load
n = Speed in rpm

**Dynamic equivalent radial load
and life calculation examples**

Bearing size: 97313 U2

Speed: 1750 RPM

Rating (C) = 40000

Case 1Thrust load (F_A) = 5000

$$\frac{F_A}{F_R} > 0.80$$

$$P = 0.39 F_R + 0.76 F_A = 0.76 \times 5000$$

$$P = 3800$$

$$C = 40000$$

$$\text{Life (L10)} = \left(\frac{C}{P}\right)^3 = \left(\frac{40000}{3800}\right)^3 = 1166 \times 10^6 \text{ Rev.}$$

or

$$\begin{aligned} \text{Life (L10h)} &= \frac{10^6}{60n} \left(\frac{C}{P}\right)^3 = \frac{10^6}{60 \times 1750} \left(\frac{40000}{3800}\right)^3 \\ &= 11100 \text{ Hours} \end{aligned}$$

Case 2Radial load (F_R) = 3000Thrust load (F_A) = 5000

$$\frac{F_A}{F_R} = 1.67$$

$$\text{Since } \frac{F_A}{F_R} > 0.80,$$

$$P = 0.39 F_R + 0.76 F_A = 0.39 \times 3000 + 0.76 \times 5000$$

$$P = 4970$$

$$C = 40000$$

$$\text{Life (L10)} = \left(\frac{C}{P}\right)^3 = \left(\frac{40000}{4970}\right)^3 = 521 \times 10^6 \text{ Rev.}$$

or

$$\begin{aligned} \text{Life (L10h)} &= \frac{10^6}{60n} \left(\frac{C}{P}\right)^3 = \frac{10^6}{60 \times 1750} \left(\frac{40000}{4970}\right)^3 \\ &= 4965 \text{ Hours} \end{aligned}$$

*Duplex 97000 UP2 Series
40 Degree Angular Contact
Bearings*

*Dynamic and static equivalent load
and life rating*

Dynamic equivalent radial load

$$P = 1.0 F_R \quad \text{when } \frac{F_A}{F_R} \leq 1.14$$

$$P = 0.35 F_R + 0.57 F_A \quad \text{when } \frac{F_A}{F_R} > 1.14$$

P = Dynamic equivalent radial load
F_R = Radial load
F_A = Thrust load

Static equivalent radial load

$$P_0 = 1.0 F_R + 0.52 F_A$$

P₀ is always $\geq F_R$

P₀ = Static equivalent radial load
F_R = Radial load
F_A = Thrust load

Life rating

$$L_{10} = \left(\frac{C}{P}\right)^3 \quad (\text{millions of revolutions})$$

or

$$L_{10h} = \frac{10^6}{60n} \left(\frac{C}{P}\right)^3 \quad (\text{Hours})$$

C = Dynamic radial load rating
P = Dynamic equivalent radial load
n = Speed in rpm

**Dynamic equivalent radial load
and life calculation examples**

Bearing size: 97314 UP2

Speed: 1750 RPM

Rating (C) = 42700

Case 1Thrust load (F_A) = 5000

$$\frac{F_A}{F_R} > 1.14$$

$$P = 0.35 F_R + 0.57 F_A = 0.57 \times 5000$$

$$P = 2850$$

$$C = 42700$$

$$\text{Life (L10)} = \left(\frac{C}{P}\right)^3 = \left(\frac{42700}{2850}\right)^3 = 3363 \times 10^6 \text{ Rev.}$$

or

$$\begin{aligned} \text{Life (L10h)} &= \frac{10^6}{60n} \left(\frac{C}{P}\right)^3 = \frac{10^6}{60 \times 1750} \left(\frac{42700}{2850}\right)^3 \\ &= 32030 \text{ Hours} \end{aligned}$$

Case 2Radial load (F_R) = 3000Thrust load (F_A) = 5000

$$\frac{F_A}{F_R} = 1.67$$

$$\text{Since } \frac{F_A}{F_R} > 1.14,$$

$$P = 0.35 F_R + 0.57 F_A = 0.35 \times 3000 + 0.57 \times 5000$$

$$P = 3900$$

$$C = 42700$$

$$\text{Life (L10)} = \left(\frac{C}{P}\right)^3 = \left(\frac{42700}{3900}\right)^3 = 1312 \times 10^6 \text{ Rev.}$$

or

$$\begin{aligned} \text{Life (L10h)} &= \frac{10^6}{60n} \left(\frac{C}{P}\right)^3 = \frac{10^6}{60 \times 1750} \left(\frac{42700}{3900}\right)^3 \\ &= 12500 \text{ Hours} \end{aligned}$$

NOTES

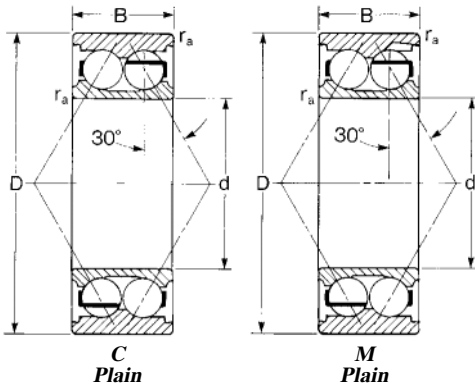

MRC double-row ball bearings are manufactured in two main types: C-type (conrad construction) and M-type (maximum capacity with filling notches). Each row has a 30° contact angle.

C-type

Conrad construction, or C-type, double-row ball bearings have contact angles that converge outside the bearing, thereby increasing resistance to misalignment. This type does not have filling notches. These bearings are recommended for applications where single-row bearings are inadequate, but radial loads are not so great as to suggest a filling-notch bearing. They will take heavy radial loads, and axial loads equally in either direction. The C-type design fully meets the requirements of American Petroleum Institute Specification 610.

Both the inner and the outer rings have closure grooves. These bearings are available with seals, shields, and snap-rings.

M-type

This type has filling notches on one side to permit assembling the maximum number of balls into the bearing. Contact angles converge outside the bearing. All inner and outer rings have closure grooves. These bearings may be equipped with seals, shields, or snap-rings; or a combination of these. The M-type bearing has very heavy radial capacity. It also has thrust capacity in one direction, with the ability to accommodate light thrust load in the reversing direction.

Part numbers on M-type double-row bearings are normally located on either the side face or the O.D. The side face marking is always on the side opposite the filling notch and the O.D. marking is offset from the center away from the filling notch. Therefore, double sealed or shielded bearings with the filling notch covered from view can be oriented correctly.

Ball Cages and Types

The cage supplied with C-type and M-type bearings is one-piece, heat-treated steel for maximum retention. It is snapped into place after the full quota of balls has been introduced between the inner and outer ring.

Size	Series	Page
5200C	Light, Non-Filling Notch	149
5200C1	Light, Extra Width, Non-Filling Notch	149
5300C	Medium, Non-Filling Notch	150
5300C1	Medium, Extra Width, Non-Filling Notch	150
5400C	Heavy, Non-Filling Notch	153
5200M	Light, Filling Notch	151
5200M1	Light, Extra Width, Filling Notch	151
5300M	Medium, Filling Notch	152
5300M1	Medium, Extra Width, Filling Notch	152
Equivalent Load and Life		154
Life Calculation Examples		155
Width Summary and Interchange to New C & M from Old Series		141
Filling Notch Location on Closed Bearings		144
Internal Clearance		145
Thrust Rating		146
Extra Wide Retrofit Kit and Mounting Instructions		147

MRC 5000 type double-row bearings are made in three series — 5200 Light, 5300 Medium, and 5400 Heavy — each with progressively larger sections. The old-style 5000 type double-rows are available in the SB Conrad and maximum capacity configurations. The SB Conrad version has contact angles which diverge inwardly, thereby increasing resistance to misalignment. The maximum capacity version has contact angles which converge inwardly, giving it the capability of handling moderate misalignment. It also has filling notches on both sides, for the introduction of a maximum complement of balls.

Our new-style double-row bearings are available in the C-type (Conrad construction) and M type (with filling notches on one side only). Both types feature inwardly diverging contact angles, which provide greater rigidity than found in previous double-row filling-notch type bearings.

A unique manufacturing system utilizing “common parts” is employed in the manufacture of the new-style bearings. Using a minimum number of components, the system provides greater flexibility for producing either conrad or maximum-capacity types as open bearings or with a variety of closures. Twenty-two variations of a single bearing size can be made, for a total of 1185 double-row bearing variations to solve your application problems.

This chart outlines the suffixes and widths of MRC 5000 type bearings. The data on this chart do not represent actual availability of double-row products. These data are intended to be used as references for interchanging. New style double-rows appear next to their old-style counterparts that are the same width.

MRC Double-Row Suffix Identification Summary

Suffix	Description
B	Rigid construction, maximum capacity
BK	Rigid construction, maximum capacity, standard width
C	Conrad, rigid construction, standard width
C1	1/8" additional width from standard; 5205C1 & 5212C1 are 1/16" wider than standard
F	One shield
FF	Two shields
G	One snap-ring
K	Standard width
M	Maximum capacity, rigid construction, standard width

Suffix	Description
M1	1/8" additional width from standard; 5205M1 & 5212M1 are 1/16" wider than standard
Plain	Maximum capacity, nonrigid construction, narrow width in 5200 series, extra width is required with closures
S	Conrad construction (note: always combined with additional suffix letters)
SB	Conrad, rigid construction, narrow width, extra width is required with closures
SBK	Conrad, rigid construction, standard width
Z	One seal
ZZ	Two seals

Basic Bearing Number	Old— Style Suffix	New— Style Suffix	Width (inches)	Basic Bearing Number	Old— Style Suffix	New— Style Suffix	Width (inches)	Basic Bearing Number	Old— Style Suffix	New— Style Suffix	Width (inches)
5200 Series				5206	F	MF1	11/16	5211	BK	M	15/16
5106	SBZZ		29/32		K	M	15/16		BKG	MG	15/16
5200	SB		9/16		KF	MF	15/16		K	M	15/16
	SBKF		9/16		KFF	MFF	15/16		KF	MF	15/16
	SBKFF		9/16		KG	MG	15/16		KFG	MFG	15/16
	SBKZ		9/16		Plain		3/4		KG	MG	15/16
	SBKZZ		9/16		SBF	CF1	11/16		Plain		13/16
5201	SB		5/8		SBK	C	15/16			C	15/16
	SBFG		5/8		SBKF	CF	15/16	5212	F	MF1	11/2
	SBKF		5/8		SBKFF	CFF	15/16		FG	MFG1	11/2
	SBKFF		5/8		SBKFFG	CFFG	15/16		K	M	17/16
	SBKFFG		5/8		SBKFG	CFG	15/16		KF	MF	17/16
	SBKFG		5/8		SBKG	CG	15/16		KFG	MFG	17/16
	SBKZ		5/8		SBZZ	CZZ1	11/16		KG	MG	17/16
	SBKZZ		5/8		SBKZZG	CZZG1	11/16		Plain		13/8
5202	Plain		5/8		—	C1, M1	11/16		—	C1, M1	11/2
	SB		5/8	5207	F	MF1	13/16		—	C	17/16
	SBFG		11/16		K	M	11/16	5213	K	M	11/2
	SBKF		5/8		KF	MF	11/16		KF	MF	11/2
	SBKFF		5/8		KFF	MFF	11/16		KFG	MFG	11/2
	SBKFG		5/8		KFG	MFG	11/16		KG	MG	11/2
	SBKZZ		5/8		KG	MG	11/16		Plain		13/8
5203	SB		11/16		Plain		7/8		—	C	11/2
	SBKF		11/16		SBK	C	11/16	5214	K	M	19/16
	SBKFF		11/16		SBKF	CF	11/16		KF	MF	19/16
	SBKFFG		11/16		SBKFF	CFF	11/16		KFG	MFG	19/16
	SBKFG		11/16		SBKFG	CFG	11/16		KG	MG	19/16
	SBKZ		11/16		SBKFFG	CFFG	11/16		Plain		17/16
	SBKZZ		11/16		SBKFG	CFG	11/16		—	C	19/16
5204	Plain		3/4		SBKFFG	CFFG	11/16	5215	K	M	15/8
	K	M	13/16		SBKG	CG	11/16		KF	MF	15/8
	KF	MF	13/16		—	C1, M1	13/16		KFF	MFF	15/8
	SB		3/4	5208	BKF	MF	13/16		KFG	MFG	15/8
	SBK	C	13/16		BKFF	MFF	13/16		KG	MG	15/8
	SBKF	CF	13/16		K	M	13/16		Plain		17/16
	SBKFF	CFF	13/16		KF	MF	13/16		—	C	15/8
	SBKFFG	CFFG	13/16		KFF	MFF	13/16	5216	BFF		17/8
	SBKFG	CFG	13/16		KFG	MFG	13/16		K	M	13/4
	SBKG	CG	13/16		KG	MG	13/16		KF	MF	13/4
	SBKZ	CZ	13/16		Plain		1		KFG	MFG	13/4
5205	F	MF1	7/8		SBK	C	13/16		KG	MG	13/4
	K	M	13/16		SBKF	CF	13/16		Plain		15/8
	KG	MG	13/16		SBKFF	CFF	13/16		—	C	13/4
	Plain		3/4		SBKFG	CFG	13/16	5217	K	M	115/16
	SB		3/4		SBKFG	CFG	13/16		KF	MF	115/16
	SBF	CF1	7/8	5209	SBKG	CG	13/16		KG	MG	115/16
	SBK	C	13/16		K	M	13/16		Plain		13/4
	SBKF	CF	13/16		KF	MF	13/16		—	C	115/16
	SBKFF	CFF	13/16		KG	MG	13/16	5218	K	M	21/16
	SBKFFG	CFFG	13/16		Plain		1		KF	MF	21/16
	SBKFG	CFG	13/16		SBK	C	13/16		KG	MG	21/16
	SBKG	CG	13/16		SBKF	CF	13/16		Plain		2
	—	C1, M1	7/8		SBKFF	CFF	13/16		—	C	21/16
				5210	K	M	13/16				
					KF	MF	13/16				
					KFF	MFF	13/16				
					KG	MG	13/16				
					Plain		1				
					—	C	13/16				

5000 Series Bearings Suffix, Width Summary

MRC Bearing Services

Basic Bearing Number	Old— Style Suffix	New— Style Suffix	Width (inches)	Basic Bearing Number	Old— Style Suffix	New— Style Suffix	Width (inches)	Basic Bearing Number	Old— Style Suffix	New— Style Suffix	Width (inches)
5219	G		2 ³ / ₁₆		FG	MFG1	1 ¹ / ₂		Plain	M	2 ¹ / ₁₆
	Plain		2 ³ / ₁₆		G	MG	1 ³ / ₈		—	C	2 ¹ / ₁₆
5220	G		2 ³ / ₈		KF	MF	1 ³ / ₈		—	C1, M1	2 ¹ / ₁₆
	Plain		2 ³ / ₈		KFG	MFG	1 ³ / ₈	5316	G	MG	2 ¹ / ₁₆
5221	Plain		2 ⁹ / ₁₆		Plain	M	1 ³ / ₈		Plain	M	2 ¹ / ₁₆
5222	KF		2 ³ / ₄		—	C1, M1	1 ¹ / ₂		—	C	2 ¹ / ₁₆
	Plain		2 ³ / ₄		—	C	1 ³ / ₈	5317	Plain	—	2 ⁷ / ₈
5300 Series				5308	BG	MG	1 ⁷ / ₁₆		—	C	2 ⁷ / ₈
5300	SB		3/4		F	MF1	1 ⁹ / ₁₆	5318	Plain	—	2 ⁷ / ₈
5301	SB		3/4		FG	MFG1	1 ⁹ / ₁₆		—	C	2 ⁷ / ₈
5302	Plain		3/4		G	MG	1 ⁷ / ₁₆	5319	Plain	—	3 ¹ / ₁₆
	SB		3/4		Plain	M	1 ⁷ / ₁₆		—	C	3 ¹ / ₁₆
5303	G		7/8		—	C	1 ⁷ / ₁₆	5320	Plain	—	3 ¹ / ₄
	KF		7/8		—	C1, M1	1 ⁹ / ₁₆	5321	Plain	—	3 ⁷ / ₁₆
	KFG		7/8	5309	B	M	1 ⁹ / ₁₆	5322	Plain	—	3 ⁵ / ₈
	SB		7/8		F	MF1	1 ¹ / ₁₆	5400 Series			
	SBG		7/8		FG	MFG1	1 ¹ / ₁₆	5403	Plain	—	1 ³ / ₁₆
	SBKF		7/8		G	MG	1 ⁹ / ₁₆	5404	Plain	—	1 ³ / ₈
	SBKFF		7/8		Plain	M	1 ⁹ / ₁₆	5405	Plain	—	1 ³ / ₈
	SBKFG		7/8		—	C	1 ⁹ / ₁₆	5406	Plain	—	1 ⁹ / ₁₆
					—	C1, M1	1 ¹ / ₁₆		—	C	1 ⁹ / ₁₆
5304	F	MF1	1	5310	F	MF1	1 ⁷ / ₈	5407	G	—	1 ³ / ₄
	Plain	M	7/8		FG	MFG1	1 ⁷ / ₈		Plain	—	1 ³ / ₄
	SB	C	7/8		G	MG	1 ³ / ₄		—	C	1 ³ / ₄
	SBF	CF1	1		KF	MF	1 ³ / ₄	5408	Plain	—	1 ⁵ / ₁₆
	SBG	CG	7/8		KFG	MFG	1 ³ / ₄		—	C	1 ⁵ / ₁₆
	SBKF	CF	7/8		Plain	M	1 ³ / ₄	5409	G	—	2 ¹ / ₈
	SBKFF	CFF	7/8		—	C	1 ³ / ₄		Plain	—	2 ¹ / ₈
	SBKFFG	CFFG	7/8		—	C1, M1	1 ⁷ / ₈		—	C	2 ¹ / ₈
	SBKFG	CFG	7/8	5311	F	MF1	2 ¹ / ₁₆	5410	F	—	2 ⁷ / ₁₆
	—	C1, M1	1		FG	MFG1	2 ¹ / ₁₆		Plain	—	2 ⁹ / ₁₆
5305	F		1 ¹ / ₈		G	MG	1 ¹ / ₁₆	5411	F	—	2 ⁵ / ₈
	FG		1 ¹ / ₈		Plain	M	1 ¹ / ₁₆		G	—	2 ¹ / ₂
	G	MG	1		—	C	1 ¹ / ₁₆		Plain	—	2 ¹ / ₂
	KFF	MFF	1		—	C1, M1	2 ¹ / ₁₆	5412	Plain	—	2 ⁵ / ₈
	Plain	M	1	5312	F	MF1	2 ¹ / ₄		—	C	2 ⁵ / ₈
	SB	C	1		FG	MFG1	2 ¹ / ₄	5413	Plain	—	2 ¹ / ₂
	SBF		1 ¹ / ₈		G	MG	2 ¹ / ₈		—	C	2 ¹ / ₂
	SBFG		1 ¹ / ₈		Plain	M	2 ¹ / ₈	5414	Plain	—	2 ¹ / ₂
	SBG	CG	1		—	C	2 ¹ / ₈		—	C	2 ¹ / ₂
	SBKF	CF	1		—	C1, M1	2 ¹ / ₄	5415	Plain	—	2 ⁵ / ₈
	SBKFF	CFF	1	5313	F	MF1	2 ⁷ / ₁₆	5416	Plain	—	2 ⁵ / ₈
	SBKFG	CFG	1		FG	MFG1	2 ⁷ / ₁₆	5417	Plain	—	2 ¹ / ₂
5306	B	M	1 ³ / ₁₆		G	MG	2 ⁵ / ₁₆	5418	Plain	—	3 ⁵ / ₈
	BKFF	MFF	1 ³ / ₁₆		Plain	M	2 ⁵ / ₁₆		—	C	3 ⁵ / ₈
	F	MF1	1 ⁵ / ₁₆		—	C	2 ⁵ / ₁₆	5419	Plain	—	4 ³ / ₁₆
	FG	MFG1	1 ⁵ / ₁₆		—	C1, M1	2 ⁷ / ₁₆				
	G	MG	1 ³ / ₁₆	5314	F	MF1	2 ⁵ / ₈				
	KF	MF	1 ³ / ₁₆		G	MG	2 ¹ / ₂				
	KFF	MFF	1 ³ / ₁₆		KF	MF	2 ¹ / ₂				
	KFG	MFG	1 ³ / ₁₆		KFG	MFG	2 ¹ / ₂				
	Plain	M	1 ³ / ₁₆		Plain	M	2 ¹ / ₂				
	—	C1, M1	1 ⁵ / ₁₆		—	C	2 ¹ / ₂				
	—	C	1 ³ / ₁₆		—	C1, M1	2 ⁵ / ₈				
5307	BKFF	MFF	1 ³ / ₈	5315	F	MF1	2 ¹ / ₁₆				
	F	MF1	1 ¹ / ₂		G	MG	2 ¹ / ₁₆				

Bearing numbers of MRC double-row ball bearings produced before 1983 differ from the new C- and M-types listed in this catalog. Shown below is the interchange of pre-1983 bearing numbers with the new C- and M-types.

5000 Series double-row bearings not listed here maintain the original bearing number and must be specified by that number when ordering.

MRC Bearing Numbers		MRC Bearing Numbers		MRC Bearing Numbers	
Prior to 1983	Superseded by	Prior to 1983	Superseded by	Prior to 1983	Superseded by
5200SB	5200C*	5211K	5211M	5306	5306M
5200SBKF	5200CF*	5211KF	5211MF	5306F	5306MF-1
5200SBKFF	5200CFF*	5211KFG	5211MFG	5306FG	5306MFG-1
5200SBKZ	5200CZ*	5211KG	5211MG	5306G	5306MG
5200SBKZZ	5200CZZ*	5212F	5212MF-1	5306KF	5306MF
5201SB	5201C*	5212FG	5212MFG-1	5306KFF	5306MFF
5201SBKF	5201CF*	5212K	5212M	5306KFG	5306MFG
5201SBKFF	5201CFF*	5212KF	5212MF	5307	5307M
5201SBKZ	5201CZ*	5212KFG	5212MFG	5307F	5307MF-1
5201SBKZZ	5201CZZ*	5212KG	5212MG	5307FG	5307MFG-1
5202SB	5202C*	5213K	5213M	5307G	5307MG
5202SBKFF	5202CF*	5213KF	5213MF	5307KF	5307MF
5202SBFG	5202CFG-1*	5213KFG	5213MFG	5307KFG	5307MFG
5202SBKFG	5202CFG*	5213KG	5213MG	5308	5308M
5202SBKZ	5202CZ*	5214K	5214M	5308F	5308MF-1
5202SBKZZ	5202CZZ*	5214KF	5214MF	5308FG	5308MFG-1
5203SB	5203C*	5214KG	5214MG	5308G	5308MG
5203SBKF	5203CF*	5215K	5215M	5309	5309M
5203SBKFF	5203CFF*	5215KF	5215MF	5309B	5309M
5203SBKFG	5203CFG*	5215KFF	5215MFF	5309F	5309MF-1
5203SBKZ	5203CZ*	5215KFG	5215MFG	5309FG	5309MFG-1
5203SBKZZ	5203CZZ*	5215KG	5215MG	5309G	5309MG
5204SBK	5204C	5216K	5216M	5310	5310M
5204SBKF	5204CF	5216KF	5216MF	5310F	5310MF-1
5204SBKFF	5204CFF	5216KFG	5216MFG	5310FG	5310MFG-1
5204SBKFG	5204CFG	5216KG	5216MG	5310G	5310MG
5204SBKFFG	5204CFFG	5217K	5217M	5310KF	5310MF
5204SBKG	5204CG	5217KF	5217MF	5310KFG	5310MFG
5204SBKZ	5204CZ	5217KG	5217MG	5311	5311M
5205SBK	5205C	5218K	5218M	5311F	5311MF-1
5205SBF	5205CF-1	5218KF	5218MF	5311FG	5311MFG-1
5205SBKF	5205CF	5218KFG	5218MFG	5311G	5311MG
5205SBKFF	5205CFF	5219	5219M	5312	5312M
5205SBKG	5205CG	5219G	5219MG	5312F	5312MF-1
5206SBK	5206C	5220	5220M	5312FG	5312MFG-1
5206SBF	5206CF-1	5220G	5220MG	5312G	5312MG
5206SBKF	5206CF	5221	5221M	5313	5313M
5206SBKFF	5206CFF	5222	5222M	5313F	5313MF-1
5206SBKFG	5206CFG	5222K	5222MG	5313FG	5313MFG-1
5206SBKG	5206CG	5222KF	5222MG	5313G	5313MG
5206SBZZ	5206CZZ-1	5300SB	5300C*	5314	5314M
5207F	5207MF-1	5301SB	5301C*	5314F	5314MF-1
5207SBK	5207C	5302SB	5302C*	5314G	5314MG
5207SBKF	5207CF	5303SB	5303C*	5314KF	5314MF
5207SBKFF	5207CFF	5303SBG	5303CG*	5315	5315M
5207SBKFG	5207CFG	5303SBKF	5303CF*	5315F	5315MF1
5207SBKG	5207CG	5303SBKFF	5303CFF*	5315G	5315MG
5208SBK	5208C	5303SBKFG	5303CFG*	5316	5316M
5208SBKF	5208CF	5304SB	5304C	5316G	5316MG
5208SBKFF	5208CFF	5304SBF	5304CF-1	5317	5317M
5208SBKFG	5208CFG	5304SBKF	5304CF	5318	5318M
5208SBKG	5208CG	5304SBKFF	5304CFF	5319	5319M
5209K	5209M	5305SB	5305C	5320	5320M
5209KF	5209MF	5305SBG	5305CG	5321	5321M
5209SBFF	5209CFF	5305SBKF	5305CF	5322	5322M
5209KG	5209MG	5305SBKFF	5305CFF		
5210K	5210M	5305SBKFG	5305CFG		
5210KF	5210MF				
5210KFF	5210MFF				
5210KG	5210MG				

*Listed for information only. Not currently in production. Use SB types.

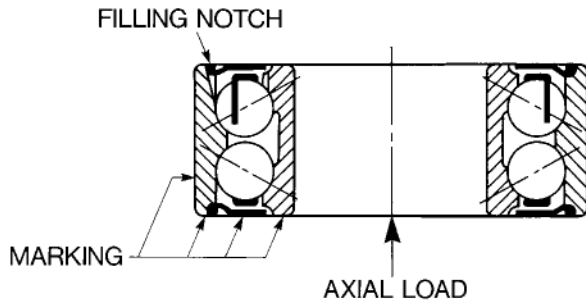
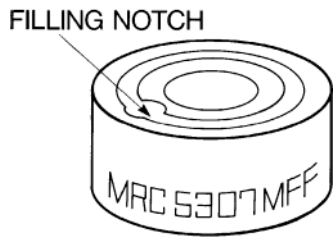

Since the filling notch row is not visible on 5000MFF and 5000MZZ bearings, it is necessary to identify which row has the notch in those cases where the bearing is subject to axial load. Axial load should be carried on the non-filling notch row. A moderate reversing axial load is permissible on the filling notch row.

A typical application of a 5000MFF or 5000MZZ bearing is shown above in which it is subjected to an axial load in an upward direction. The bearing should be mounted with the filling notch up so that the axial load is taken by the bottom, non-filling notch row.

The filling notch is oriented in relation to the bearing identification marking on the bearing which will be found in one of the following locations:

- Face of the outer ring
- Face of the inner ring
- OD surface of the outer ring
- Face of the closure

In each case the marking will occur on the side of the bearing opposite the filling notch as illustrated above. When the O.D. surface marking is "right side up" the filling notch is in the uppermost row and it is located closest to the non-filling notch row.

5200 and 5300 Series

Bore Diameter d				Axial Internal Clearance															
Over		Including		C2				Normal C0				C3				C4			
mm	in	mm	in	.001 mm		.0001 in		.001 mm		.0001 in		.001 mm		.0001 in		.001 mm		.0001 in	
				Min	Max	Min	Max	Min	Max	Min	Max	Min	Max	Min	Max	Min	Max	Min	Max
10	.3937	10	.3937	1	11	0	4	5	21	2	8	12	28	5	11	25	45	10	18
18	.7087	18	.7087	1	12	0	5	6	23	2	9	13	31	5	12	27	47	11	19
		24	.9449	2	14	1	6	7	25	3	10	16	34	6	13	28	48	11	19
24	.9449	30	1.1811	2	15	1	6	8	27	3	11	18	37	7	15	30	50	12	20
30	1.1811	40	1.5748	2	16	1	6	9	29	4	11	21	40	8	16	33	54	13	21
40	1.5748	50	1.9685	2	18	1	7	11	33	4	13	23	44	9	17	36	58	14	23
50	1.9685	65	2.5591	3	22	1	9	13	36	5	14	26	48	10	19	40	63	16	25
65	2.5591	80	3.1496	3	24	1	9	15	40	6	16	30	54	12	21	46	71	18	28
80	3.1496	100	3.9370	3	26	1	10	18	46	7	18	35	63	14	25	55	83	22	33
100	3.9370	110	4.3307	4	30	2	12	22	53	9	21	42	73	17	29	65	96	26	38

Bore Diameter d				Radial Internal Clearance															
Over		Including		C2				Normal C0				C3				C4			
mm	in	mm	in	.001 mm		.0001 in		.001 mm		.0001 in		.001 mm		.0001 in		.001 mm		.0001 in	
				Min	Max	Min	Max	Min	Max	Min	Max	Min	Max	Min	Max	Min	Max	Min	Max
10	.3937	10	.3937	0.6	7	0	2.4	3	13	1.2	5	8	18	3	7	15	27	6	11
18	.7087	18	.7087	0.6	7	0	3	3.6	14	1.2	5	8	18	3	7	18	27	7	11
		24	.9449	1.2	8	0.6	3.6	4	15	1.8	6	11	21	4	8	18	27	7	11
24	.9449	30	1.1811	1.2	9	0.6	3.6	5	16	1.8	7	11	23	4	9	18	31	7	12
30	1.1811	40	1.5748	1.2	10	0.6	3.6	5	17	2.4	7	12	25	5	10	21	33	8	13
40	1.5748	50	1.9685	1.2	11	0.6	4	7	20	2.4	8	12	25	5	10	21	36	8	14
50	1.9685	65	2.5591	1.8	13	0.6	5	8	22	3	8	15	27	6	11	25	38	10	15
65	2.5591	80	3.1496	1.8	14	0.6	5	9	24	3.6	10	18	33	7	13	27	44	11	17
80	3.1496	100	3.9370	1.8	16	0.6	6	11	28	4	11	21	38	8	15	33	50	13	20
100	3.9370	110	4.3307	2.4	18	1.2	7	13	32	5	13	25	44	10	17	40	58	16	23

5400 Series

Bore Diameter d				Axial Internal Clearance															
Over		Including		C2				Normal C0				C3				C4			
mm	in	mm	in	.001 mm		.0001 in		.001 mm		.0001 in		.001 mm		.0001 in		.001 mm		.0001 in	
				Min	Max	Min	Max	Min	Max	Min	Max	Min	Max	Min	Max	Min	Max	Min	Max
30	1.1811	30	1.1811	2	15	1	6	8	27	3	11	28	47	11	19	45	75	18	30
40	1.5748	40	1.5748	2	16	1	6	9	29	4	11	31	50	12	20	48	84	19	33
		50	1.9685	2	18	1	7	11	33	4	13	33	54	13	21	51	90	20	35
50	1.9685	65	2.5591	3	22	1	9	13	36	5	14	36	58	14	23	55	96	22	38
65	2.5591	70	2.7559	3	24	1	9	15	40	6	16	40	64	16	25	61	106	24	42
70	2.7559	80	3.1496	0	165	0	65	165	305	65	120	305	430	120	170	430	510	170	200
80	3.1496	90	3.5433	0	200	0	80	200	360	80	140	360	480	140	190	480	610	190	240

Bore Diameter d				Radial Internal Clearance															
Over		Including		C2				Normal C0				C3				C4			
mm	in	mm	in	.001 mm		.0001 in		.001 mm		.0001 in		.001 mm		.0001 in		.001 mm		.0001 in	
				Min	Max	Min	Max	Min	Max	Min	Max	Min	Max	Min	Max	Min	Max	Min	Max
30	1.1811	30	1.1811	1	8	0.4	3	2	13	1	5	13	23	5	9	20	38	8	15
40	1.5748	40	1.5748	1	8	0.5	3	6	13	2	5	15	23	6	9	23	41	9	16
		50	1.9685	1	8	0.5	3	6	15	2	6	15	25	6	10	23	44	9	17
50	1.9685	65	2.5591	1	11	0.5	4	6	15	2	6	15	28	6	11	25	45	10	18
65	2.5591	70	2.7559	1	11	0.5	4	6	18	2	7	18	31	7	12	28	48	11	19
70	2.7559	80	3.1496	0	6	0	2	6	18	2	7	18	33	7	13	33	48	13	19
80	3.1496	90	3.5433	0	7	0	3	7	23	3	9	23	44	9	17	44	65	17	26

Thrust Rating Of Double-Row Ball Bearings-5000 Series

MRC Bearing Services

Dynamic Rating

To obtain dynamic thrust rating multiply dynamic radial rating C by the factor shown below.

Size	Factor
5200SB-5203SB	0.71
5300SB-5303SB	
5403C-5414C	
5204C&M-5218C&M	0.81
5304C&M-5319C&M	

Example:

Bearing size: 5307C

Basic dynamic radial load rating (C) = 11100 lbf

Thrust rating factor = 0.81

Thrust rating = $0.81 \times 11100 = 8991$

Static Rating

To obtain static thrust rating multiply static radial rating C_0 by the factor shown below.

Size	Factor
5200SB-5203SB	0.57
5300SB-5303SB	
5204C&M-5206C&M	
5403C-5414C	
5207C&M-5218C&M	0.66
5304C&M-5319C&M	

Sizes 5415C-5419C have 0° contact angles and are not included in the above tables. When thrust load is present, the equivalent radial load should be used to determine life.

Example:

Bearing size: 5214M

Basic static radial load rating (C_0) = 28100 lbf

Thrust rating factor = 0.66

Thrust rating = $0.66 \times 28100 = 18550$

Double-row ball bearings with non-standard extra wide width are currently available as a retrofit kit. These replacement units consist of a standard width double-row ball bearing and two specially designed spacers packaged together in a single carton.

Spacers

The Extra-Width Double-Row Ball Bearing Retrofit Kit is simple to use. When used with bearings without snap rings, place both spacers on the same side, as shown in Figure 1.

With snap ring bearings, the inner ring spacer must be installed on the side opposite the snap ring, as shown in Figure 2. The outer spacer is not needed in applications where the bearing's snap ring controls the axial location of the outer ring in the housing.

The spacers accommodate slight variations in the shaft and housing seat width. The inner ring and spacer can be secured to the shaft with a retaining ring or threaded

locknut. If a locknut is used, the amount of clamping force can be regulated to make slight adjustments in the shaft's axial location. The spacer rings yield slightly when an axial clamping force is applied. The spacer rings also exert a reaction force, which helps maintain the initial clamping force and helps prevent the inner ring from becoming loose on the shaft. The same circumstances apply to the outer ring spacers when an end cap is used to clamp the bearing's outer ring against a housing shoulder.

Because the spacer rings are designed to yield slightly when axial clamping forces are applied, the spacer rings should always be replaced with new spacer rings anytime the bearing is removed, replaced or reinstalled.

Materials for Rings, Balls and Spacers

High-carbon chromium vacuum-processed steel (SAE 52100) is used for all balls and rings. Machined and roll formed spacer rings are fabricated from 1018 carbon steel and 304 stainless steel.

Mounting Instructions

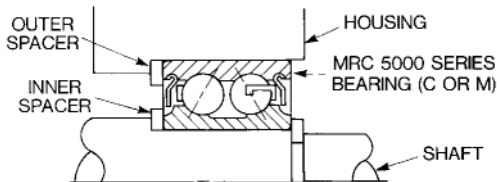

Figure 1

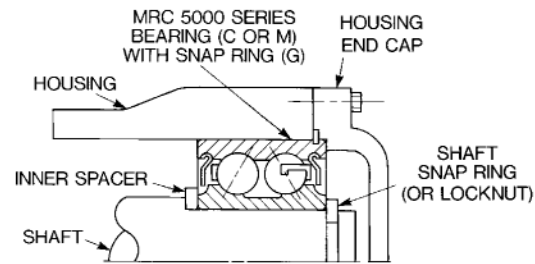

Figure 2

Without Snap Ring

1. Install inner and outer ring spacers onto the shaft and into the housing bore respectively.
2. Install bearing in accordance with normal mounting instructions.
3. If any locking devices such as snap rings or locknuts are normally used to secure the bearing on the shaft or in the housing be sure they are properly installed.
4. These inner and outer ring spacers are adjusted to proper width prior to installation. During bearing installation their width may be slightly altered to accommodate variations in shaft and housing shoulder distances. As a consequence, when a new extra width retrofit bearing kit is installed the new spacer rings supplied with the kit should always be used and the old spacers discarded.

With Snap Ring

1. Install the inner ring spacer onto the shaft. The outer ring spacer is not used with a snap ring bearing and may be discarded.
2. Install bearing in accordance with normal mounting instructions.
3. If any locking devices such as snap rings, locknuts or end caps are normally used to secure the bearing on the shaft or in the housing be sure they are properly installed.
4. These inner and outer ring spacers are adjusted to proper width prior to installation. During bearing installation their width may be slightly altered to accommodate variations in shaft and housing shoulder distances. As a consequence, when a new extra width retrofit bearing kit is installed the new spacer rings supplied with the kit should always be used and the old spacers discarded.

Part Numbers

MRC Bearing Services

A listing of available part numbers appears below. This listing may change with sizes being added or deleted based on demand.

MRC Part Number	Width including Spacers		
	Inches	mm	
5205CF1	$\frac{7}{8}$.8750	22.23
5205MF1*	$\frac{7}{8}$.8750	22.23
5206CF1	$1\frac{1}{16}$	1.0625	26.99
5206MF1	$1\frac{1}{16}$	1.0625	26.99
5206SBZZ	$1\frac{1}{16}$	1.0625	26.99
5212MF1	$1\frac{1}{2}$	1.5000	38.10
5304CF1	1	1.0000	25.40
5304MF1	1	1.0000	25.40
5305CF1	$1\frac{1}{8}$	1.1250	28.58
5305MFG1	$1\frac{1}{8}$	1.1250	28.58
5306MFG1	$1\frac{5}{16}$	1.3125	33.34
5306MF1	$1\frac{5}{16}$	1.3125	33.34
5307MF1	$1\frac{1}{2}$	1.5000	38.10
5307MFG1	$1\frac{1}{2}$	1.5000	38.10
5308MFG1	$1\frac{9}{16}$	1.5625	39.69
5308MF1	$1\frac{9}{16}$	1.5625	39.69
5309MFG1	$1\frac{11}{16}$	1.6875	42.86
5309MF1	$1\frac{11}{16}$	1.6875	42.86
5310MFG1	$1\frac{7}{8}$	1.8750	47.63
5310MF1	$1\frac{7}{8}$	1.8750	47.63
5311MFG1	$2\frac{1}{16}$	2.0625	52.39
5311MF1	$2\frac{1}{16}$	2.0625	52.39
5312MFG1	$2\frac{1}{4}$	2.2500	57.15
5312MF1	$2\frac{1}{4}$	2.2500	57.15
5313MFG1	$2\frac{7}{16}$	2.4375	61.91
5313MF1	$2\frac{7}{16}$	2.4375	61.91
5315MF1	$2\frac{13}{16}$	2.8125	71.44

*Currently stocked. No spacer needed.

Nomenclature

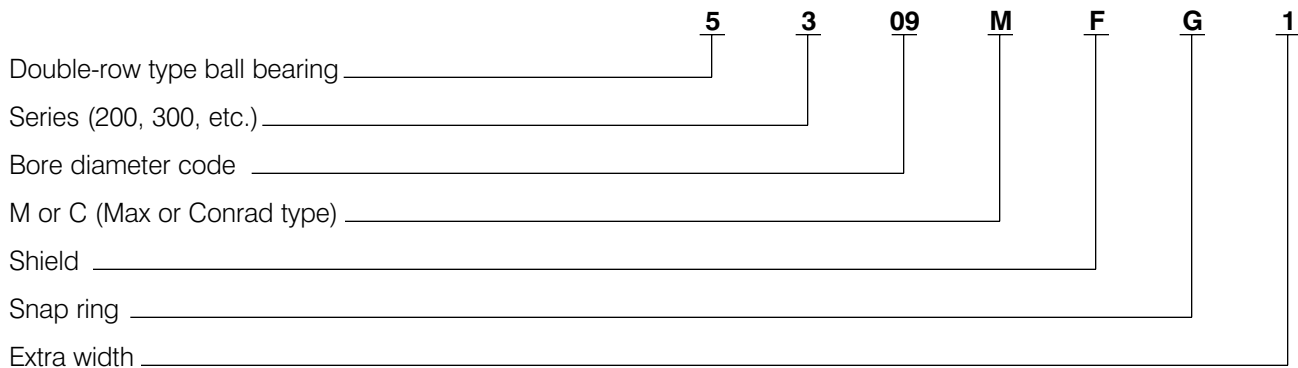

5200-C bearings are used with moderate to heavy radial loads, two-directional thrust loads, or a combination of both.

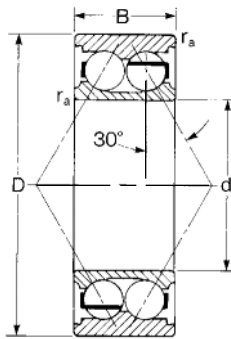

MRC Bearing Number	Bore		Outside Diameter D		Width B		Fillet Radius ¹⁾ r _a		Basic Radial Load Rating				Speed Rating ²⁾		
	d mm	in	mm	in	mm	in	mm	in	Dynamic C ³⁾		Static C ₀		Open and Shielded Grease		Single and Double Sealed Grease
									N	lbf	N	lbf	RPM	RPM	RPM
5200-SB	10	.3937	30	1.1811	14.3	.5630	.64	.025	7 610	1 710	4 300	967	16 000	22 000	16 000
5201-SB	12	.4724	32	1.2598	15.9	.6260	.64	.025	10 400	2 340	5 600	1 260	15 000	20 000	15 000
5202-SB	15	.5906	35	1.3780	15.9	.6260	.64	.025	11 400	2 560	6 800	1 530	12 000	17 000	12 000
5203-SB	17	.6693	40	1.5748	17.5	.6890	.64	.025	14 300	3 210	8 800	1 980	10 000	15 000	10 000
5204-C	20	.7874	47	1.8504	20.6	.8110	1.0	.04	19 000	4 270	12 000	2 700	9 000	13 000	9 000
5205-C	25	.9843	52	2.0472	20.6	.8110	1.0	.04	20 800	4 680	14 000	3 150	8 000	11 000	8 000
5205-C1	25	.9843	52	2.0472	22.2	.8740	1.0	.04	20 800	4 680	14 000	3 150	8 000	11 000	8 000
5206-C	30	1.1811	62	2.4409	23.8	.9370	1.0	.04	28 600	6 430	20 400	4 590	7 000	9 500	7 000
5206-C1	30	1.1811	62	2.4409	27.0	1.0630	1.0	.04	28 600	6 430	20 400	4 590	7 000	9 500	7 000
5207-C	35	1.3780	72	2.8346	27.0	1.0630	1.0	.04	37 700	8 480	27 500	6 180	6 000	8 000	6 000
5207-C1	35	1.3780	72	2.8346	30.2	1.1890	1.0	.04	37 700	8 480	27 500	6 180	6 000	8 000	6 000
5208-C	40	1.5748	80	3.1496	30.2	1.1890	1.0	.04	44 900	10 100	34 000	7 640	5 600	7 500	5 600
5209-C	45	1.7717	85	3.3465	30.2	1.1890	1.0	.04	48 800	11 000	39 000	8 770	5 000	6 700	5 000
5210-C	50	1.9685	90	3.5433	30.2	1.1890	1.0	.04	48 800	11 000	39 000	8 770	4 800	6 300	4 800
5211-C	55	2.1654	100	3.9370	33.3	1.3110	1.5	.06	57 200	12 900	47 500	10 700	4 300	5 600	4 300
5212-C	60	2.3622	110	4.3307	36.5	1.4370	1.5	.06	70 200	15 800	58 500	13 200	3 800	5 000	3 800
5212-C1	60	2.3622	110	4.3307	38.1	1.5000	1.5	.06	70 200	15 800	58 500	13 200	3 800	5 000	3 800
5213-C	65	2.5591	120	4.7244	38.1	1.5000	1.5	.06	80 600	18 100	73 500	16 500	3 600	4 800	3 600
5214-C	70	2.7559	125	4.9213	39.7	1.5630	1.5	.06	88 400	19 900	80 000	18 000	3 200	4 300	3 200
5215-C	75	2.9528	130	5.1181	41.3	1.6260	1.5	.06	95 600	21 500	88 000	19 800	3 200	4 300	3 200
5216-C	80	3.1496	140	5.5118	44.4	1.7480	2.0	.08	106 000	23 900	95 000	21 400	2 800	3 800	2 800
5217-C	85	3.3465	150	5.9055	49.2	1.9370	2.0	.08	124 000	27 900	110 000	24 700	2 600	3 600	2 600
5218-C	90	3.5433	160	6.2992	52.4	2.0630	2.0	.08	130 000	29 300	120 000	27 000	2 400	3 400	2 400
5219-C	95	3.7402	170	6.6929	55.6	2.1890	2.0	.08	159 000	35 700	146 000	32 800	2 200	3 200	2 200
5220-C	100	3.9370	180	7.0866	60.3	2.3740	2.0	.08	178 000	40 000	166 000	37 300	2 000	3 000	2 000
5221-C	105	4.1339	190	7.4803	65.1	2.5630	2.0	.08	186 000	41 800	180 000	40 500	1 800	2 800	1 800
5222-C	110	4.3307	200	7.8740	69.8	2.7480	2.0	.08	203 000	45 600	200 000	45 000	1 600	2 600	1 600

¹⁾ Fillet radius indicates maximum fillet radius on shaft or in housing which bearing corner will clear.

²⁾ Listed values are for pressed steel cage, ABEC-1.

The values have been determined through historical application and practice. For a more complete explanation, see page 276.

³⁾ Rating for one million revolutions or 500 hours at 33 1/3 RPM.

Note: Extra width bearings identified by the suffix C1 are supplied with a retrofit kit described on pages 147, 148.

5300-C bearings are used with heavy radial loads, two-directional thrust loads, or a combination of both.

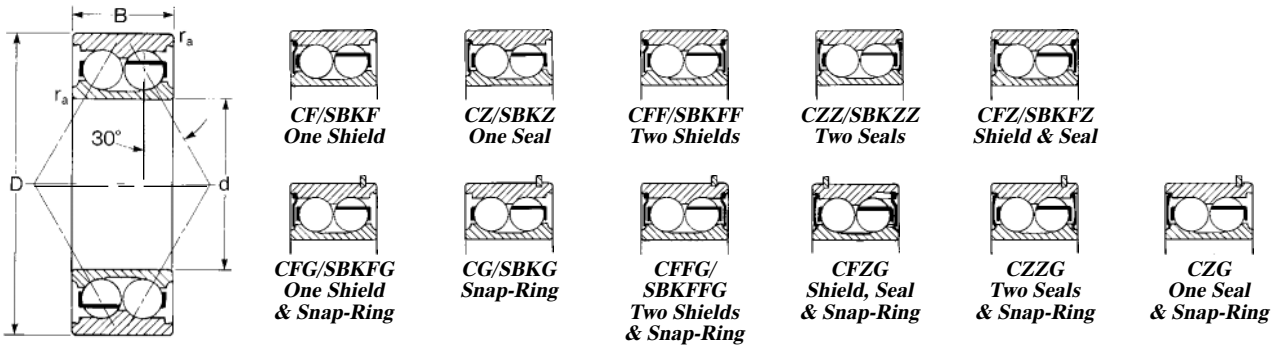

MRC Bearing Number	Bore		Outside Diameter D		Width B		Fillet Radius ¹⁾ r _a		Basic Radial Load Rating				Speed Rating ²⁾		
	d mm	in	mm	in	mm	in	mm	in	Dynamic C ³⁾		Static C ₀		Open and Shielded Grease Oil		Single and Double Sealed Grease
									N	lbf	N	lbf	RPM	RPM	RPM
5300-SB	10	.3937	35	1.3780	19.1	.7520	.64	.025	10 600	2 380	6 100	1 370	15 000	20 000	15 000
5301-SB	12	.4724	37	1.4567	19.1	.7520	1.0	.04	11 700	2 630	6 800	1 530	14 000	18 000	14 000
5302-SB	15	.5906	42	1.6535	19.1	.7520	1.0	.04	15 100	3 390	9 300	2 090	11 000	15 000	11 000
5303-SB	17	.6693	47	1.8504	22.2	.8740	1.0	.04	21 600	4 860	12 700	2 860	11 000	14 000	11 000
5304-C	20	.7874	52	2.0472	22.2	.8740	1.0	.04	22 500	5 060	14 600	3 280	8 500	12 000	8 500
5304-C1	20	.7874	52	2.0472	25.4	1.0000	1.0	.04	22 500	5 060	14 600	3 280	8 500	12 000	8 500
5305-C	25	.9843	62	2.4409	25.4	1.0000	1.0	.04	30 700	6 910	20 400	4 590	7 500	10 000	7 500
5306-C	30	1.1811	72	2.8346	30.2	1.1890	1.0	.04	41 600	9 360	29 000	6 520	6 300	8 500	6 300
5306-C1	30	1.1811	72	2.8346	33.3	1.3110	1.0	.04	41 600	9 360	29 000	6 520	6 300	8 500	6 300
5307-C	35	1.3780	80	3.1496	34.9	1.3740	1.5	.06	49 400	11 100	34 500	7 760	5 600	7 500	5 600
5307-C1	35	1.3780	80	3.1496	38.1	1.5000	1.5	.06	49 400	11 100	34 500	7 760	5 600	7 500	5 600
5308-C	40	1.5748	90	3.5433	36.5	1.4370	1.5	.06	60 500	13 600	43 000	9 760	5 000	6 700	5 000
5308-C1	40	1.5748	90	3.5433	39.7	1.5630	1.5	.06	60 500	13 600	43 000	9 760	5 000	6 700	5 000
5309-C	45	1.7717	100	3.9370	39.7	1.5630	1.5	.06	72 800	16 400	53 000	11 900	4 500	6 000	4 500
5309-C1	45	1.7717	100	3.9370	42.9	1.6890	1.5	.06	72 800	16 400	53 000	11 900	4 500	6 000	4 500
5310-C	50	1.9685	110	4.3307	44.4	1.7480	2.0	.08	85 200	19 200	64 000	14 400	4 000	5 300	4 000
5310-C1	50	1.9685	110	4.3307	47.6	1.8740	2.0	.08	85 200	19 200	64 000	14 400	4 000	5 300	4 000
5311-C	55	2.1654	120	4.7244	49.2	1.9370	2.0	.08	106 000	23 900	81 500	18 300	3 800	5 000	3 800
5311-C1	55	2.1654	120	4.7244	52.4	2.0630	2.0	.08	106 000	23 900	81 500	18 300	3 800	5 000	3 800
5312-C	60	2.3622	130	5.1181	54.0	2.1260	2.0	.08	121 000	27 200	95 000	21 400	3 400	4 500	3 400
5312-C1	60	2.3622	130	5.1181	57.2	2.2520	2.0	.08	121 000	27 200	95 000	21 400	3 400	4 500	3 400
5313-C	65	2.5591	140	5.5118	58.7	2.3110	2.0	.08	138 000	31 100	108 000	24 300	3 200	4 300	3 200
5313-C1	65	2.5591	140	5.5118	61.9	2.4370	2.0	.08	138 000	31 100	108 000	24 300	3 200	4 300	3 200
5314-C	70	2.7559	150	5.9055	63.5	2.6970	2.0	.08	153 000	34 400	125 000	28 100	2 800	3 800	2 800
5314-C1	70	2.7559	150	5.9055	66.7	2.6260	2.0	.08	153 000	34 400	125 000	28 100	2 800	3 800	2 800
5315-C	75	2.9528	160	6.2992	68.3	2.6890	2.0	.08	168 000	37 800	140 000	31 500	2 600	3 600	2 600
5315-C1	75	2.9528	160	6.2992	71.4	2.8110	2.0	.08	168 000	37 800	140 000	31 500	2 600	3 600	2 600
5316-C	80	3.1496	170	6.6929	68.3	2.6890	2.0	.08	182 000	41 000	156 000	35 100	2 400	3 400	2 400
5317-C	85	3.3465	180	7.0866	73.0	2.8740	2.5	.10	195 000	43 900	176 000	39 600	2 200	3 200	2 200
5318-C	90	3.5433	190	7.4803	73.0	2.8740	2.5	.10	212 000	47 700	196 000	44 100	2 000	3 000	2 000
5319-C	95	3.7402	200	7.8740	77.8	3.0430	2.5	.10	234 000	52 700	224 000	50 400	1 900	2 800	1 900
5320-C	100	3.9370	215	8.425	82.6	3.2520	2.5	.10	255 000	57 300	255 000	57 300	1 800	2 600	1 800
5322-C	110	4.3307	240	9.4488	92.1	3.6260	2.5	.10	291 000	65 400	305 000	68 600	1 700	2 400	1 700

¹⁾ Fillet radius indicates maximum fillet radius on shaft or in housing which bearing corner will clear.

²⁾ Listed values are for pressed steel cage, ABEC-1.

The values have been determined through historical application and practice. For a more complete explanation, see page 276.

³⁾ Rating for one million revolutions or 500 hours at 33 1/3 RPM.

Note: Extra width bearings identified by the suffix C1 are supplied with a retrofit kit described on pages 147, 148.

5200M bearings are used with heavy radial loads, two-directional thrust loads, or a combination of both. Thrust load should be carried on the non-filling notch row. Moderate thrust load is permissible on the filling notch row.

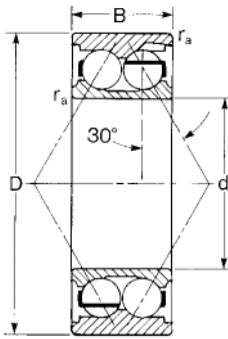

MRC Bearing Number	Bore		Outside Diameter D		Width B		Fillet Radius ¹⁾ r _s		Basic Radial Load Rating				Speed Rating ²⁾		
	d mm	in	mm	in	mm	in	mm	in	Dynamic C ³⁾		Static C ₀		Open and Shielded Grease		Single and Double Sealed Grease
									N	lbf	N	lbf	RPM	RPM	RPM
5204-M	20	.7874	47	1.8504	20.6	.8110	1.0	.04	20 500	4 610	17 000	3 820	9 000	13 000	9 000
5205-M	25	.9843	52	2.0472	20.6	.8110	1.0	.04	22 900	5 150	21 200	4 770	8 000	11 000	8 000
5205-M1	25	.9843	52	2.0472	22.2	.8740	1.0	.04	22 900	5 150	21 200	4 770	8 000	11 000	8 000
5206-M	30	1.1811	62	2.4409	23.8	.9370	1.0	.04	30 200	6 820	28 000	6 290	7 000	9 500	7 000
5206-M1	30	1.1811	62	2.4409	27.0	1.0630	1.0	.04	30 300	6 820	28 000	6 290	7 000	9 500	7 000
5207-M	35	1.3780	72	2.8346	27.0	1.0630	1.0	.04	39 100	8 800	36 500	8 210	6 000	8 000	6 000
5207-M1	35	1.3780	72	2.8346	30.2	1.1890	1.0	.04	39 100	8 800	36 500	8 210	6 000	8 000	6 000
5208-M	40	1.5748	80	3.1496	30.2	1.1890	1.0	.04	49 500	11 100	49 000	11 000	5 600	7 500	5 600
5209-M	45	1.7717	85	3.3465	30.2	1.1890	1.0	.04	51 200	11 500	54 000	12 100	5 000	6 700	5 000
5210-M	50	1.9685	90	3.5433	30.2	1.1890	1.0	.04	53 900	12 100	58 500	13 200	4 800	6 300	4 800
5211-M	55	2.1654	100	3.9370	33.3	1.3110	1.5	.06	66 000	14 900	76 500	17 200	4 300	5 600	4 300
5212-M	60	2.3622	110	4.3307	36.5	1.4370	1.5	.06	78 100	17 600	88 000	19 800	3 800	5 000	3 800
5212-M1	60	2.3622	110	4.3307	38.1	1.5000	1.5	.06	78 100	17 600	88 000	19 800	3 800	5 000	4 300
5213-M	65	2.5591	120	4.7244	38.1	1.5000	1.5	.06	88 000	19 800	106 000	23 800	3 600	4 800	3 600
5214-M	70	2.7559	125	4.9213	39.7	1.5630	1.5	.06	101 000	22 700	125 000	28 100	3 200	4 300	3 200
5215-M	75	2.9528	130	5.1181	41.3	1.6260	1.5	.06	108 000	24 300	137 000	30 800	3 200	4 300	3 200
5216-M	80	3.1496	140	5.5118	44.4	1.7480	2.0	.08	128 000	28 800	160 000	36 000	2 800	3 800	2 800
5217-M	85	3.3465	150	5.9055	49.2	1.9370	2.0	.08	142 000	32 000	176 000	39 600	2 600	3 600	2 600
5218-M	90	3.5433	160	6.2992	52.4	2.0630	2.0	.08	151 000	34 000	193 000	43 400	2 400	3 400	2 400

¹⁾ Fillet radius indicates maximum fillet radius on shaft or in housing which bearing corner will clear.

²⁾ Listed values are for pressed steel cage, ABEC-1.

The values have been determined through historical application and practice. For a more complete explanation, see page 276.

³⁾ Rating for one million revolutions or 500 hours at 33 1/3 RPM.

Note: Extra width bearings identified by the suffix M1 are supplied with a retrofit kit described on pages 147, 148.

5200M bearings are used with heavy radial loads, two-directional thrust loads, or a combination of both. Thrust load should be carried on the non-filling notch row. Moderate thrust load is permissible on the filling notch row.

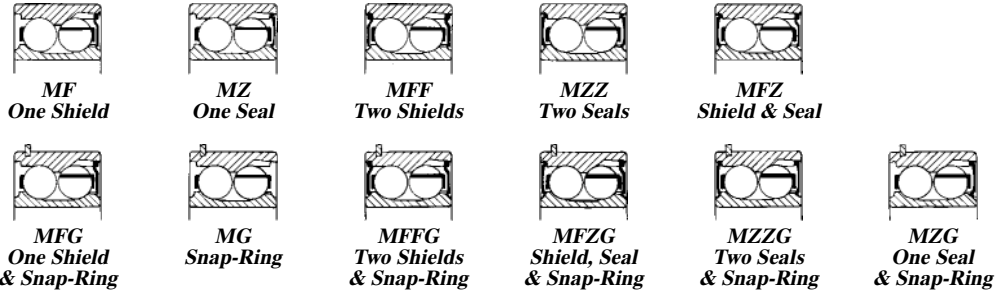
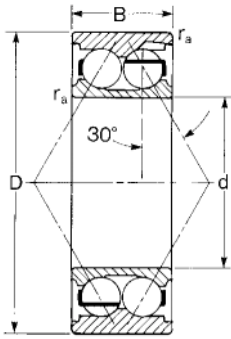

MRC Bearing Number	Bore		Outside Diameter D		Width B		Fillet Radius ¹⁾ r _a		Basic Radial Load Rating				Speed Rating ²⁾		
	d mm	in	mm	in	mm	in	mm	in	Dynamic C ³⁾		Static C ₀		Open and Shielded Oil Grease		Single and Double Sealed Grease
									N	lbf	N	lbf	RPM	RPM	RPM
5304-M	20	.7874	52	2.0472	22.2	.8740	1.0	.04	23 800	5 360	20 000	4 500	8 500	12 000	8 500
5304-M1	20	.7874	52	2.0472	25.4	1.0000	1.0	.04	23 800	5 360	20 000	4 500	8 500	12 000	8 500
5305-M	25	.9843	62	2.4409	25.4	1.0000	1.0	.04	34 100	7 670	30 500	6 860	7 500	10 000	7 500
5306-M	30	1.1811	72	2.8346	30.2	1.1890	1.0	.04	46 800	10 500	43 000	9 670	6 300	8 500	6 300
5306-M1	30	1.1811	72	2.8346	33.3	1.3110	1.0	.04	46 800	10 500	43 000	9 670	6 300	8 500	6 300
5307-M	35	1.3780	80	3.1496	34.9	1.3740	1.5	.06	52 300	11 800	48 000	10 800	5 600	7 500	5 600
5307-M1	35	1.3780	80	3.1496	38.1	1.5000	1.5	.06	52 300	11 800	48 000	10 800	5 600	7 500	5 600
5308-M	40	1.5748	90	3.5433	36.5	1.4370	1.5	.06	67 100	15 100	65 500	14 700	5 000	6 700	5 000
5308-M1	40	1.5748	90	3.5433	39.7	1.5630	1.5	.06	67 100	15 100	65 500	14 700	5 000	6 700	5 000
5309-M	45	1.7717	100	3.9370	39.7	1.5630	1.5	.06	80 900	18 200	80 000	18 000	4 500	6 000	4 500
5309-M1	45	1.7717	100	3.9370	42.9	1.6890	1.5	.06	80 900	18 200	80 000	18 000	4 500	6 000	4 500
5310-M	50	1.9685	110	4.3307	44.4	1.7480	2.0	.08	95 200	21 400	95 000	21 400	4 000	5 300	4 000
5310-M1	50	1.9685	110	4.3307	47.6	1.8740	2.0	.08	95 200	21 400	95 000	21 400	4 000	5 300	4 000
5311-M	55	2.1654	120	4.7244	49.2	1.9370	2.0	.08	119 000	26 800	122 000	27 400	3 800	5 000	3 800
5311-M1	55	2.1654	120	4.7244	52.4	2.0630	2.0	.08	119 000	26 800	122 000	27 400	3 800	5 000	3 800
5312-M	60	2.3622	130	5.1181	54.0	2.1260	2.0	.08	134 000	30 200	143 000	32 100	3 400	4 500	3 400
5312-M1	60	2.3622	130	5.1181	57.2	2.2520	2.0	.08	134 000	30 200	143 000	32 100	3 400	4 500	3 400
5313-M	65	2.5591	140	5.5118	58.7	2.3110	2.0	.08	154 000	34 700	163 000	36 600	3 200	4 300	3 200
5313-M1	65	2.5591	140	5.5118	61.9	2.4370	2.0	.08	154 000	34 700	163 000	36 600	3 200	4 300	3 200
5314-M	70	2.7559	150	5.9055	63.5	2.5000	2.0	.08	172 000	38 700	186 000	41 800	2 800	3 800	2 800
5314-M1	70	2.7559	150	5.9055	66.7	2.6260	2.0	.08	172 000	38 700	186 000	41 800	2 800	3 800	2 800
5315-M	75	2.9528	160	6.2992	68.3	2.6890	2.0	.08	187 000	42 000	208 000	46 800	2 600	3 600	2 600
5315-M1	75	2.9528	160	6.2992	71.4	2.8110	2.0	.08	187 000	42 000	208 000	46 800	2 600	3 600	2 600
5316-M	80	3.1496	170	6.6929	68.3	2.6890	2.0	.08	201 000	45 200	236 000	53 100	2 400	3 400	2 400
5317	85	3.3465	180	7.0866	73.0	2.8740	2.5	.10	198 000	44 500	245 000	55 100	2 200	3 200	2 200
5318	90	3.5433	190	7.4803	73.0	2.8740	2.5	.10	224 000	50 400	290 000	65 200	2 000	3 000	2 000
5319	95	3.7402	200	7.8740	77.8	3.0630	2.5	.10	242 000	54 400	315 000	70 800	1 900	2 800	1 900
5321	105	4.1339	225	8.8583	87.3	3.4370	2.5	.10	275 000	60 700	390 000	87 700	1 800	2 600	1 800

¹⁾ Fillet radius indicates maximum fillet radius on shaft or in housing which bearing corner will clear.
²⁾ Listed values are for pressed steel cage, ABEC-1.
 The values have been determined through historical application and practice. For a more complete explanation, see page 276.
³⁾ Rating for one million revolutions or 500 hours at 33 1/3 RPM.
 Note: Extra width bearings identified by the suffix M1 are supplied with a retrofit kit described on pages 147, 148.

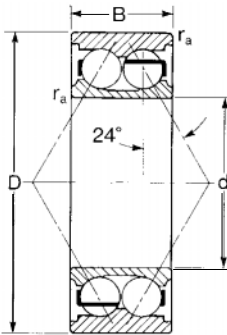

5400 Series bearings are used with extremely heavy radial loads, two-directional thrust loads, or a combination of both.

5406-5414 have a 24° contact angle per row.

5415-5418 have a zero degree contact angle.

MRC Bearing Number	Bore d		Outside Diameter D		Width B		Fillet Radius ¹⁾ r _a	Basic Radial Load Rating				Speed Rating ²⁾		
								Dynamic C ³⁾		Static C ₀		Grease RPM	Oil RPM	
								N	lbf	N	lbf			
5406C	30	1.1811	90	3.5433	39.7	1.5630	1.5	.06	67 600	15 200	45 000	10 100	5 300	7 000
5407C	35	1.3780	100	3.9370	44.4	1.7480	1.5	.06	76 100	17 000	49 000	11 000	4 800	6 300
5408C	40	1.5748	110	4.3307	49.2	1.9370	2.0	.08	88 400	19 900	57 000	12 800	4 300	5 600
5409C	45	1.7717	120	4.7244	54.0	2.1260	2.0	.08	112 000	25 200	78 000	17 600	4 000	5 300
5410C	50	1.9685	130	5.1181	58.7	2.3110	2.0	.08	143 000	32 200	102 000	23 000	3 600	4 800
5411C	55	2.1654	140	5.5118	63.5	2.5000	2.0	.08	146 000	32 900	102 000	23 000	3 200	4 300
5412C	60	2.3622	150	5.9055	66.7	2.6260	2.0	.08	159 000	35 800	114 000	25 700	3 000	4 000
5413C	65	2.5591	160	6.2992	71.4	2.8110	2.0	.08	195 000	43 900	156 000	35 100	2 800	3 800
5414C	70	2.7559	180	7.0866	79.4	3.1260	2.5	.10	199 000	44 800	156 000	35 100	2 400	3 400
5415C	75	2.9528	190	7.4803	82.6	3.2520	2.5	.10	212 000	47 700	200 000	45 000	2 200	3 200
5416C	80	3.1496	200	7.8740	87.3	3.4370	2.5	.10	229 000	51 500	216 000	48 600	2 000	3 000
5417C	85	3.3465	210	8.2677	92.1	3.6260	3.0	.12	255 000	57 300	255 000	57 300	1 900	2 800
5418C	90	3.5433	225	8.8583	98.4	3.8740	3.0	.12	281 000	63 200	300 000	67 400	1 800	2 600

¹⁾ Fillet radius indicates maximum fillet radius on shaft or in housing which bearing corner will clear.

²⁾ Listed values are for pressed steel cage, ABEC-1.

The values have been determined through historical application and practice. For a more complete explanation, see page 276.

³⁾ Rating for one million revolutions or 500 hours at 33 1/3 RPM.

Dynamic and static equivalent radial load and life rating

Dynamic equivalent radial load

$P = XF_R + YF_A$ P = Dynamic equivalent radial load
 F_R = Radial load
 F_A = Thrust load
 X = Radial load factor
 Y = Thrust load factor
 C_0 = Basic static radial load rating
 e = Limiting factor for F_A/F_R

Static equivalent radial load

$P = X_0F_R + Y_0F_A$ P_0 = Static equivalent radial load
 F_R = Radial load
 F_A = Thrust load
 X_0 = Radial load factor
 Y_0 = Thrust load factor

Size	e	$F_A/F_R \leq e$		$F_A/F_R > e$	
		X	Y	X	Y
5200SB-5206C&M 5300SB-5303SB 5403C-5414C	0.66	1.0	0.92	0.67	1.41
5207C&M-5218C&M 5304C&M-5319C&M	0.80	1.0	0.78	0.63	1.24

Size	X	Y
5200SB-5206C&M 5300SB-5303SB 5403C-5414C	1.0	0.76
5207C&M-5218C&M 5304C&M-5319C&M	1.0	0.66
5415C-5419C	0.60	0.50

Po is always $\geq F_R$

Size	F_A/C_0	Normal Clearance (ST Fit)			C3 Clearance (LO Fit)		
		e	X	Y	e	X	Y
5415C-5419C	0.025	0.22	0.56	2.0	0.25	0.52	1.8
	0.040	0.24	0.56	1.8	0.28	0.52	1.65
	0.070	0.27	0.56	1.6	0.30	0.52	1.5
	0.13	0.31	0.56	1.4	0.34	0.52	1.33
	0.25	0.37	0.56	1.2	0.40	0.52	1.17
	0.50	0.44	0.56	1.0	0.48	0.52	1.0

Values of Y and e for loads not shown are obtained by linear interpolation.

Life Rating

$L_{10} = \left(\frac{C}{P}\right)^3$ (Millions of revolutions)

or

$L_{10h} = \frac{10^6}{60n} \left(\frac{C}{P}\right)^3$ (Hours)

- C = Basic dynamic load rating
- P = Dynamic equivalent radial load
- n = Speed in RPM

Dynamic equivalent radial load and life calculation examples

Bearing size: 5210 M
 Speed: 2000 RPM
 Basic dynamic radial load rating (C) = 12100 lbf

Bearing size: 5203 SB
 Speed: 2000 RPM
 Basic dynamic radial load Rating (C) = 3330

Case 1

Radial load (F_R) = 1750
 $F_A/F_R = 0/1750 = 0$
 Equivalent load (P) = $X F_R + Y F_A$
 Since $F_A/F_R < e$, equivalent load (P) =
 $1.0 F_R + 0.78 F_A = 1.0 \times 1750 = 1750$
 Life (L10) = $\left(\frac{C}{P}\right)^3 = \left(\frac{12100}{1750}\right)^3 = 331 \times 10^6$ Rev.
 or
 Life (L10h) = $\frac{10^6}{60n} \left(\frac{C}{P}\right)^3 = \frac{10^6}{60 \times 2000} \left(\frac{12100}{1750}\right)^3$
 = 2755 Hrs

Case 1

Radial load (F_R) = 500
 $F_A/F_R = 0/500 = 0$
 Equivalent load (P) = $X F_R + Y F_A$
 Since $F_A/F_R < e$, equivalent load (P) =
 $1.0 F_R + 0.78 F_A = 1.0 \times 500 = 500$
 Life (L10) = $\left(\frac{C}{P}\right)^3 = \left(\frac{3330}{500}\right)^3 = 295 \times 10^6$ Rev.
 or
 Life (L10h) = $\frac{10^6}{60n} \left(\frac{C}{P}\right)^3 = \frac{10^6}{60 \times 2000} \left(\frac{3330}{500}\right)^3$
 = 2462 Hrs

Case 2

Radial load (F_R) = 1750
 Thrust load (F_A) = 1300
 $F_A/F_R = 1300/1750 = 0.74$
 Equivalent load (P) = $X F_R + Y F_A$
 Since $F_A/F_R < e$, equivalent load (P) =
 $1.0 F_R + 0.78 F_A = 1.0 \times 1750 + 0.78 \times 1300 = 2764$
 Life (L10) = $\left(\frac{C}{P}\right)^3 = \left(\frac{12100}{2764}\right)^3 = 83.9 \times 10^6$ Rev.
 or
 Life (L10h) = $\frac{10^6}{60n} \left(\frac{C}{P}\right)^3 = \frac{10^6}{60 \times 2000} \left(\frac{12100}{2764}\right)^3$
 = 699 Hrs

Case 2

Radial load (F_R) = 500
 Thrust load (F_A) = 325
 $F_A/F_R = 325/500 = 0.65$
 Equivalent load (P) = $X F_R + Y F_A$
 Since $F_A/F_R < e$, equivalent load (P) =
 $1.0 F_R + 0.92 F_A = 1.0 \times 500 + 0.792 \times 1325 = 799$
 Life (L10) = $\left(\frac{C}{P}\right)^3 = \left(\frac{3330}{799}\right)^3 = 72.4 \times 10^6$ Rev.
 or
 Life (L10h) = $\frac{10^6}{60n} \left(\frac{C}{P}\right)^3 = \frac{10^6}{60 \times 2000} \left(\frac{3330}{799}\right)^3$
 = 603 Hrs

Case 3

Radial load (F_R) = 1750
 Thrust load (F_A) = 13500
 $F_A/F_R = 1500/1750 = 0.86$
 Equivalent load (P) = $X F_R + Y F_A$
 Since $F_A/F_R < e$, equivalent load (P) =
 $0.63 F_R + 1.24 F_A = 0.63 \times 1750 + 1.24 \times 1500$
 = 2963
 Life (L10) = $\left(\frac{C}{P}\right)^3 = \left(\frac{12100}{2963}\right)^3 = 68.1 \times 10^6$ Rev.
 or
 Life (L10h) = $\frac{10^6}{60n} \left(\frac{C}{P}\right)^3 = \frac{10^6}{60 \times 2000} \left(\frac{12100}{2963}\right)^3$
 = 568 Hrs

Case 3

Radial load (F_R) = 500
 Thrust load (F_A) = 375
 $F_A/F_R = 375/500 = 0.75$
 Equivalent load (P) = $X F_R + Y F_A$
 Since $F_A/F_R > e$, equivalent load (P) =
 $0.67 F_R + 1.41 F_A$
 = $0.67 \times 500 + 1.41 \times 375 = 864$
 Life (L10) = $\left(\frac{C}{P}\right)^3 = \left(\frac{3330}{864}\right)^3 = 57.3 \times 10^6$ Rev.
 or
 Life (L10h) = $\frac{10^6}{60n} \left(\frac{C}{P}\right)^3 = \frac{10^6}{60 \times 2000} \left(\frac{3330}{864}\right)^3$
 = 477 Hrs

Case 4

Thrust load (F_R) = 1500
 $F_A/F_R = 1500/0 = \infty$
 Equivalent load (P) = $X F_R + Y F_A$
 Since $F_A/F_R > e$, equivalent load (P) =
 $0.63 F_R + 1.24 F_A = 1.24 \times 1500 = 1860$
 Life (L10) = $\left(\frac{C}{P}\right)^3 = \left(\frac{12100}{1860}\right)^3 = 275 \times 10^6$ Rev.
 or
 Life (L10h) = $\frac{10^6}{60n} \left(\frac{C}{P}\right)^3 = \frac{10^6}{60 \times 2000} \left(\frac{12100}{1860}\right)^3$
 = 2294 Hrs

Case 4

Thrust load (F_R) = 375
 $F_A/F_R = 375/0 = \infty$
 Equivalent load (P) = $X F_R + Y F_A$
 Since $F_A/F_R > e$, equivalent load (P) =
 $0.67 F_R + 1.41 F_A = 1.41 \times 375 = 529$
 Life (L10) = $\left(\frac{C}{P}\right)^3 = \left(\frac{3330}{529}\right)^3 = 249 \times 10^6$ Rev.
 or
 Life (L10h) = $\frac{10^6}{60n} \left(\frac{C}{P}\right)^3 = \frac{10^6}{60 \times 2000} \left(\frac{3330}{529}\right)^3$
 = 2075 Hrs

NOTES

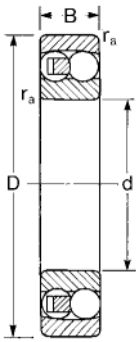

Self-aligning bearings have two rows of balls with a common sphered raceway in the outer ring. This gives the bearings their self-aligning property, permitting angular misalignment of the shaft relative to the housing. They are therefore particularly suitable for applications where misalignment can arise from errors in mounting or from shaft deflection.

Bearing sizes having the E suffix have higher load ratings than the original standard design because of improvements in internal construction. They are supplied with a glass fiber reinforced, 6/6 polyamide cage as standard. Machined brass or pressed steel cages are supplied on other sizes.

Series	Page
100	159
1200, 1200E	159
1300, 1300E	160
1400	160
2200, 2200E	161
2300, 2300E	161
1200K, 1200EK—Tapered Bore	162
1300K, 1300EK—Tapered Bore	162
2200K, 2200EK—Tapered Bore	163
2300K, 2300EK—Tapered Bore	163
1200K, 1200EK—Tapered Bore with Adapter Sleeve	164
1300K, 1300EK—Tapered Bore with Adapter Sleeve	164
2200K, 2200EK—Tapered Bore with Adapter Sleeve	165
2300K, 2300EK—Tapered Bore with Adapter Sleeve	165
2200E2RS1—Two Seals	166
2300E2RS1—Two Seals	166
2200E2RS1K—Two Seals and Tapered Bore	166
11200E—Extended Inner Ring	167
11300E—Extended Inner Ring	167
Equivalent Load and Life	169
Life Calculation Examples	169
Internal Clearance	168
Allowable Angular Misalignment	168
Minimum Required Radial Load	170
Ball Protrusion Beyond Bearing Face	171
Mounting Procedure	172

Basic Design

Self-aligning bearings of the basic design are available with both a cylindrical bore and a tapered bore with a 1:12 taper. Tapered bore bearings are furnished with adapter sleeves, including nut and lock washer, with which the bearings can be secured to smooth or stepped shafts. They are identified by suffix letter K.

Sealed Bearings

Self-aligning bearings with cylindrical and tapered bores are available with contact seals on both sides, identified by the suffix 2RS1. The seals are made of oil and wear resistant synthetic rubber reinforced by a steel insert. The operating temperature range for the seals, with a suitable grease, is -40°C to 120°C (-40°F to 248°F). Sealed bearings are supplied with a lithium base grease suitable for an operating temperature range of -30°C to 110°C (-22°F to 230°F).

Sealed bearings with a tapered bore require a special adapter sleeve and lockwasher identified by the suffix letter C. The lockwashers have a circular beading on the side facing the bearing to prevent interference with the seal.

Extended Inner Ring Bearings

Self-aligning bearings with an extended inner ring are used in applications employing commercial ground shafting. A special bore tolerance allows easy mounting and dismounting.

These bearings are located axially by pins or shouldered screws which engage in a slot at one side of the inner ring. The pins or screws also prevent the inner ring from turning on the shaft. When used in pairs, the slots on the inner ring must either be adjacent or at the outboard positions to provide shaft location in both directions.

Tolerances

Self-aligning bearings are manufactured to ABEC-1 tolerances as shown on page 241). The exceptions are the bore and inner ring width on extended inner ring bearings, which are manufactured to the tolerances shown in the table below.

All tolerances in ten thousandths inches (.0001) and micrometers (mm).

Note: Top figure is inch, bottom is micrometer.

Bore Diameter (mm) Over	Incl	Bore Diameter Tolerance		Bore Out-of-Round (Max)	Inner Ring Width + .000" + .00mm
		+3	-3		
2.5	10	+3	-3	6	-130
		+8	-8	14	-330
10	18	+3	-3	6	-130
		+8	-8	14	-330
18	30	+4	-4	7	-130
		+10	-10	17	-330
30	50	+5	-5	8	-153
		+12	-12	21	-390
50	80	+6	-6	10	-181
		+15	-15	26	-460

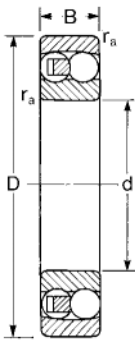

Cylindrical bore

MRC Bearing Number	Bore		Outside Diameter D		Width B		Fillet Radius ¹⁾ r _a		Calculation Factors				Basic Radial Load Rating				Speed Rating	
									e	Y ₁	Y ₂	Y ₀	Dynamic C _d ²⁾		Static C ₀		Grease RPM	Oil RPM
	d	mm	in	mm	in	mm	in	mm	in					N	lbf	N	lbf	
135	5	.1969	19	.7480	6	.2362	.30	.012	.33	1.9	3	2	2 510	564	480	108	32 000	38 000
126	6	.2362	19	.7480	6	.2362	.30	.012	.33	1.9	3	2	2 510	564	480	108	32 000	38 000
127	7	.2756	22	.8661	7	.2756	.30	.012	.33	1.9	3	2	2 650	596	560	126	30 000	36 000
108	8	.3150	22	.8661	7	.2756	.30	.012	.33	1.9	3	2	2 650	596	560	126	30 000	36 000
129	9	.3543	26	1.0236	8	.3150	.60	.024	.33	1.9	3	2	3 900	877	815	183	26 000	32 000
1200E	10	.3937	30	1.1811	9	.3543	.60	.024	.33	1.9	3	2	5 530	1 240	1 180	265	24 000	30 000
1201E	12	.4724	32	1.2598	10	.3937	.60	.024	.33	1.9	3	2	6 240	1 400	1 430	321	22 000	28 000
1202E	15	.5906	35	1.3780	11	.4331	.60	.024	.33	1.9	3	2	7 410	1 670	1 760	396	19 000	24 000
1203E	17	.6693	40	1.5748	12	.4724	.60	.024	.31	2	3.1	2.2	8 840	1 990	2 200	495	18 000	22 000
1204E	20	.7874	47	1.8504	14	.5512	1.0	.039	.30	2.1	3.3	2.2	12 700	2 860	3 400	764	15 000	18 000
1205E	25	.9843	52	2.0472	15	.5906	1.0	.039	.28	2.2	3.5	2.5	14 300	3 220	4 000	899	13 000	16 000
1206E	30	1.1811	62	2.4409	16	.6299	1.0	.039	.25	2.5	3.9	2.5	15 600	3 510	4 650	1 050	10 000	13 000
1207E	35	1.3780	72	2.8346	17	.6693	1.0	.039	.23	2.7	4.2	2.8	19 000	4 270	6 000	1 350	9 000	11 000
1208E	40	1.5748	80	3.1496	18	.7087	1.0	.039	.22	2.9	4.5	2.8	19 900	4 470	6 950	1 560	8 500	10 000
1209E	45	1.7717	85	3.3465	19	.7480	1.0	.039	.21	3	4.6	3.2	22 900	5 150	7 800	1 750	7 500	9 000
1210E	50	1.9685	90	3.5433	20	.7874	1.0	.039	.21	3	4.6	3.2	26 500	5 960	9 150	2 060	7 000	8 500
1211E	55	2.1654	100	3.9370	21	.8268	1.5	.059	.19	3.3	5.1	3.6	27 600	6 210	10 600	2 380	6 300	7 500
1212E	60	2.3622	110	4.3307	22	.8661	1.5	.059	.19	3.3	5.1	3.6	31 200	7 010	12 200	2 740	5 600	6 700
1213E	65	2.5591	120	4.7244	23	.9055	1.5	.059	.18	3.5	5.4	3.6	35 100	7 890	14 000	3 150	5 300	6 300
1214	70	2.7559	125	4.9213	24	.9449	1.5	.059	.18	3.5	5.4	3.6	34 500	7 760	13 700	3 080	5 000	6 000
1215	75	2.9528	130	5.1181	25	.9843	1.5	.059	.17	3.7	5.7	4	39 000	8 770	15 600	3 510	4 800	5 600
1216	80	3.1496	140	5.5118	26	1.0236	2.0	.079	.16	3.9	6.1	4	39 700	8 930	17 000	3 820	4 500	5 300
1217	85	3.3465	150	5.9055	28	1.1024	2.0	.079	.17	3.7	5.7	4	48 800	11 000	20 800	4 680	4 000	4 800
1218	90	3.5433	160	6.2992	30	1.1811	2.0	.079	.17	3.7	5.7	4	57 200	12 900	23 600	5 310	3 800	4 500
1219	95	3.7402	170	6.6929	32	1.2598	2.0	.079	.17	3.7	5.7	4	63 700	14 300	27 000	6 070	3 600	4 300
1220	100	3.9370	180	7.0866	34	1.3386	2.0	.079	.17	3.7	5.7	4	68 900	15 500	30 000	6 740	3 400	4 000
1221	105	4.1339	190	7.4803	36	1.4173	2.0	.079	.17	3.7	5.7	4	74 100	16 700	32 500	7 310	3 200	3 800
1222	110	4.3307	200	7.8740	38	1.4961	2.0	.079	.17	3.7	5.7	4	88 400	19 900	39 000	8 770	3 000	3 600
1224	120	4.7244	215	8.4646	42	1.6535	2.0	.079	.19	3.3	5.1	3.6	119 000	26 800	53 000	11 900	2 800	3 400
1226	130	5.1181	230	9.0551	46	1.8110	2.5	.098	.19	3.3	5.1	3.6	127 000	28 600	58 500	13 200	2 600	3 200

¹⁾ Fillet radius indicates maximum fillet radius on shaft or in housing which bearing corner will clear.

²⁾ Rating for one million revolutions or 500 hours at 33 1/3 RPM.

1300, 1300-E, 1400 Series Self-Aligning Ball Bearings

MRC Bearing Services

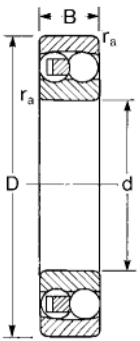

Cylindrical Bore

MRC Bearing Number	Bore		Outside Diameter D		Width B		Fillet Radius ¹⁾ r _a		Calculation Factors				Basic Radial Load Rating				Speed Rating	
	d mm	in	mm	in	mm	in	mm	in	e	Y ₁	Y ₂	Y ₀	Dynamic C _d ²⁾		Static C ₀		Grease RPM	Oil RPM
													N	lbf	N	lbf		
1301E	12	.4724	37	1.4567	12	.4724	1.0	.039	.35	1.8	2.8	1.8	9 360	2 100	2 160	486	18 000	22 000
1302E	15	.5906	42	1.6535	13	.5118	1.0	.039	.31	2	3.1	2.2	10 800	2 430	2 600	585	17 000	20 000
1303E	17	.6693	47	1.8504	14	.5512	1.0	.039	.30	2.1	3.3	2.2	12 700	2 860	3 400	764	14 000	17 000
1304E	20	.7874	52	2.0472	15	.5906	1.0	.039	.28	2.2	3.5	2.5	14 300	3 220	4 000	899	12 000	15 000
1305E	25	.9843	62	2.4409	17	.6693	1.0	.039	.28	2.2	3.5	2.5	19 000	4 270	5 400	1 210	9 500	12 000
1306E	30	1.1811	72	2.8346	19	.7480	1.0	.039	.25	2.5	3.9	2.5	22 500	5 060	6 800	1 530	9 000	11 000
1307E	35	1.3780	80	3.1496	21	.8268	1.5	.059	.25	2.5	3.9	2.5	26 500	5 960	8 500	1 910	7 500	9 000
1308E	40	1.5748	90	3.5433	23	.9055	1.5	.059	.23	2.7	4.2	2.8	33 800	7 600	11 200	2 520	6 700	8 000
1309E	45	1.7717	100	3.9370	25	.9843	1.5	.059	.23	2.7	4.2	2.8	39 000	8 770	13 400	3 010	6 300	7 500
1310E	50	1.9685	110	4.3307	27	1.0630	2.0	.079	.24	2.6	4.1	2.8	43 600	9 800	14 000	3 150	5 600	6 700
1311E	55	2.1654	120	4.7244	29	1.1417	2.0	.079	.23	2.7	4.2	2.8	50 700	11 400	18 000	4 050	5 000	6 000
1312E	60	2.3622	130	5.1181	31	1.2205	2.0	.079	.23	2.7	4.2	2.8	58 500	13 200	22 000	4 950	4 500	5 300
1313E	65	2.5591	140	5.5118	33	1.2992	2.0	.079	.22	2.9	4.5	2.8	65 000	14 600	25 500	5 730	4 300	5 000
1314	70	2.7559	150	5.9055	35	1.3780	2.0	.079	.22	2.9	4.5	2.8	74 100	16 700	27 500	6 180	4 000	4 800
1315	75	2.9528	160	6.2992	37	1.4567	2.0	.079	.22	2.9	4.5	2.8	79 300	17 800	30 000	6 740	3 800	4 500
1316	80	3.1496	170	6.6929	39	1.5354	2.0	.079	.22	2.9	4.5	2.8	88 400	19 900	33 500	7 530	3 600	4 300
1317	85	3.3465	180	7.0866	41	1.6142	2.5	.098	.22	2.9	4.5	2.8	97 500	21 900	38 000	8 540	3 400	4 000
1318	90	3.5433	190	7.4803	43	1.6929	2.5	.098	.22	2.9	4.5	2.8	117 000	26 300	44 000	9 890	3 200	3 800
1319	95	3.7402	200	7.8740	45	1.7717	2.5	.098	.23	2.7	4.2	2.8	133 000	29 900	51 000	11 500	3 000	3 600
1320	100	3.9370	215	8.4646	47	1.8504	2.5	.098	.23	2.7	4.2	2.8	143 000	32 200	57 000	12 800	2 800	3 400
1322	110	4.3307	240	9.4488	50	1.9685	2.5	.098	.22	2.9	4.5	2.8	163 000	36 600	72 000	16 200	2 400	3 000
1406	30	1.1811	90	3.5433	28	1.1024	1.5	.059	.40	1.6	2.4	1.6	59 200	13 300	17 000	3 820	6 700	8 000
1407	35	1.3780	100	3.9370	30	1.1811	1.5	.059	.37	1.7	2.6	1.8	62 400	14 000	18 000	4 050	6 300	7 500
1408	40	1.5748	110	4.3307	33	1.2992	2.0	.079	.35	1.8	2.8	1.8	76 100	17 100	23 600	5 310	5 300	6 300
1409	45	1.7717	120	4.7244	35	1.3780	2.0	.079	.35	1.8	2.8	1.8	88 400	19 900	27 500	6 180	5 000	6 000
1410	50	1.9685	130	5.1181	37	1.4567	2.0	.079	.35	1.8	2.8	1.8	101 000	22 700	32 000	7 190	4 800	5 600
1411	55	2.1654	140	5.5118	40	1.5748	2.0	.079	.33	1.9	3	2	111 000	25 000	36 500	8 210	4 300	5 000
1412	60	2.3622	150	5.9055	42	1.6535	2.0	.079	.33	1.9	3	2	125 000	28 100	41 500	9 330	3 800	4 500

¹⁾ Fillet radius indicates maximum fillet radius on shaft or in housing which bearing corner will clear.

²⁾ Rating for one million revolutions or 500 hours at 33 1/3 RPM.

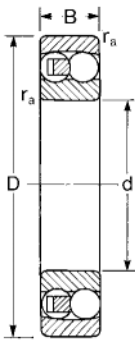

Cylindrical bore

MRC Bearing Number	Bore		Outside Diameter D		Width B		Fillet Radius ¹⁾ r _a		Calculation Factors				Basic Radial Load Rating				Speed Rating	
									e	Y ₁	Y ₂	Y ₀	Dynamic C _d ²⁾		Static C ₀		Grease RPM	Oil RPM
	d	in	mm	in	mm	in	mm	in					N	lbf	N	lbf		
2200E	10	.3937	30	1.1811	14	.5512	.60	.024	.54	1.15	1.8	1.3	8 060	1 810	1 730	389	22 000	28 000
2201E	12	.4724	32	1.2598	14	.5512	.60	.024	.50	1.25	2	1.3	8 520	1 920	1 900	427	20 000	26 000
2202E	15	.5906	35	1.3780	14	.5512	.60	.024	.43	1.5	2.3	1.6	8 710	1 960	2 040	459	18 000	22 000
2203E	17	.6693	40	1.5748	16	.6299	.60	.024	.43	1.5	2.3	1.6	10 600	2 380	2 550	573	17 000	20 000
2204E	20	.7874	47	1.8504	18	.7087	1.0	.039	.40	1.6	2.4	1.6	16 800	3 780	4 150	933	14 000	17 000
2205E	25	.9843	52	2.0472	18	.7087	1.0	.039	.35	1.8	2.8	1.8	16 800	3 780	4 400	989	11 000	14 000
2206E	30	1.1811	62	2.4409	20	.7874	1.0	.039	.33	1.9	3	2	23 800	5 350	6 700	1 510	9 500	12 000
2207E	35	1.3780	72	2.8346	23	.9055	1.0	.039	.31	2	3.1	2.2	30 700	6 900	8 800	1 980	8 500	10 000
2208E	40	1.5748	80	3.1496	23	.9055	1.0	.039	.28	2.2	3.5	2.5	31 900	7 170	10 000	2 250	7 500	9 000
2209E	45	1.7717	85	3.3465	23	.9055	1.0	.039	.26	2.4	3.7	2.5	32 500	7 310	10 600	2 380	7 000	8 500
2210E	50	1.9685	90	3.5433	23	.9055	1.0	.039	.23	2.7	4.2	2.8	33 800	7 600	11 200	2 520	6 300	7 500
2211E	55	2.1654	100	3.9370	25	.9843	1.5	.059	.23	2.7	4.2	2.8	39 000	8 770	13 400	3 010	6 000	7 000
2212E	60	2.3622	110	4.3307	28	1.1024	1.5	.059	.24	2.6	4.1	2.8	48 800	11 000	17 000	3 820	5 300	6 300
2213E	65	2.5591	120	4.7244	31	1.2205	1.5	.059	.24	2.6	4.1	2.8	57 200	12 900	20 000	4 500	5 000	6 000
2214	70	2.7559	125	4.9213	31	1.2205	1.5	.059	.27	2.3	3.6	2.5	44 200	9 940	17 000	3 820	4 800	5 600
2215	75	2.9528	130	5.1181	31	1.2205	1.5	.059	.25	2.5	3.9	2.5	44 200	9 940	18 000	4 050	4 500	5 300
2216E	80	3.1496	140	5.5118	33	1.2992	2.0	.079	.22	2.9	4.5	2.8	65 000	14 600	25 500	5 730	4 000	4 800
2217	85	3.3465	150	5.9055	36	1.4173	2.0	.079	.25	2.5	3.9	2.5	58 500	13 200	23 600	5 310	3 800	4 500
2218	90	3.5433	160	6.2992	40	1.5748	2.0	.079	.27	2.3	3.6	2.5	70 200	15 800	28 500	6 410	3 600	4 300
2219	95	3.7402	170	6.6929	43	1.6929	2.0	.079	.27	2.3	3.6	2.5	83 200	18 700	34 500	7 760	3 400	4 000
2220	100	3.9370	180	7.0866	46	1.8110	2.0	.079	.27	2.3	3.6	2.5	97 500	21 900	40 500	9 110	3 200	3 800
2221	105	4.1339	190	7.4803	50	1.9685	2.0	.079	.28	2.2	3.5	2.5	108 000	24 300	45 000	10 100	3 000	3 600
2222	110	4.3307	200	7.8740	53	2.0866	2.0	.079	.28	2.2	3.5	2.5	124 000	27 900	52 000	11 700	2 800	3 400
2301	12	.4724	37	1.4567	17	.6693	1.0	.039	.60	1.05	1.6	1.1	11 700	2 630	2 700	607	17 000	20 000
2302	15	.5906	42	1.6535	17	.6693	1.0	.039	.52	1.2	1.9	1.3	11 900	2 680	2 900	652	15 000	18 000
2303	17	.6693	47	1.8504	19	.7480	1.0	.039	.52	1.2	1.9	1.3	14 600	3 280	3 550	798	13 000	16 000
2304	20	.7874	52	2.0472	21	.8268	1.0	.039	.52	1.2	1.9	1.3	18 200	4 090	4 750	1 070	11 000	14 000
2305	25	.9843	62	2.4409	24	.9449	1.0	.039	.48	1.3	2	1.4	24 200	5 440	6 550	1 470	9 500	12 000
2306	30	1.1811	72	2.8346	27	1.0630	1.0	.039	.44	1.4	2.2	1.4	31 200	7 010	8 800	1 980	8 500	10 000
2307E	35	1.3780	80	3.1496	31	1.2205	1.5	.059	.46	1.35	2.1	1.4	39 700	8 930	11 200	2 520	7 000	8 500
2308E	40	1.5748	90	3.5433	33	1.2992	1.5	.059	.40	1.6	2.4	1.6	54 000	12 100	16 000	3 600	6 300	7 500
2309E	45	1.7717	100	3.9370	36	1.4173	1.5	.059	.33	1.9	3	2	63 700	14 300	19 300	4 340	5 600	6 700
2310	50	1.9685	110	4.3307	40	1.5748	2.0	.079	.43	1.5	2.3	1.6	63 700	14 300	20 000	4 500	5 300	6 300
2311	55	2.1654	120	4.7244	43	1.6929	2.0	.079	.40	1.6	2.4	1.6	76 100	17 100	24 000	5 400	4 800	5 600
2312	60	2.3622	130	5.1181	46	1.8110	2.0	.079	.33	1.9	3	2	87 100	19 600	28 500	6 410	4 500	5 300
2313	65	2.5591	140	5.5118	48	1.8898	2.0	.079	.37	1.7	2.6	1.8	95 600	21 500	32 500	7 310	4 000	4 800
2314	70	2.7559	150	5.9055	51	2.0079	2.0	.079	.37	1.7	2.6	1.8	111 000	25 000	37 500	8 430	3 800	4 500
2315	75	2.9528	160	6.2992	55	2.1654	2.0	.079	.37	1.7	2.6	1.8	124 000	27 900	43 000	9 670	3 400	4 000
2316	80	3.1496	170	6.6929	58	2.2835	2.0	.079	.37	1.7	2.6	1.8	135 000	30 400	49 000	11 000	3 200	3 800
2317	85	3.3465	180	7.0866	60	2.3622	2.5	.098	.37	1.7	2.6	1.8	140 000	31 500	51 000	11 500	3 000	3 600
2318	90	3.5433	190	7.4803	64	2.5197	2.5	.098	.37	1.7	2.6	1.8	153 000	34 400	57 000	12 800	2 800	3 400
2319	95	3.7402	200	7.8740	67	2.6378	2.5	.098	.37	1.7	2.6	1.8	165 000	37 100	64 000	14 400	2 600	3 200
2320	100	3.9370	215	8.4646	73	2.8740	2.5	.098	.37	1.7	2.6	1.8	190 000	42 700	80 000	18 000	2 400	3 000
2322	110	4.3307	240	9.4488	80	3.1496	2.5	.098	.37	1.7	2.6	1.8	216 000	48 600	95 000	21 400	2 200	2 800

¹⁾ Fillet radius indicates maximum fillet radius on shaft or in housing which bearing corner will clear.

²⁾ Rating for one million revolutions or 500 hours at 33 1/3 RPM.

1200-K, 1200-EK, 1300-K, 1300-EK Series
Self-Aligning Ball Bearings with Tapered Bore

MRC Bearing Services

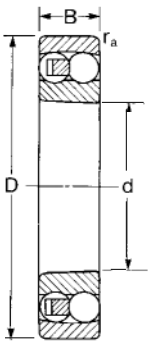

Tapered bore
 taper 1:12 on diameter

MRC Bearing Number	Bore		Outside Diameter D		Width B		Fillet Radius ¹⁾ r _a		Calculation Factors				Basic Radial Load Rating				Speed Rating	
									e	Y ₁	Y ₂	Y ₀	Dynamic C _d ²⁾		Static C ₀		Grease RPM	Oil RPM
	d	mm	in	mm	in	mm	in	mm	in					N	lbf	N	lbf	
1204EK	20	.7874	47	1.8504	14	.5512	1.0	.039	.30	2.1	3.3	2.2	12 700	2 860	3 400	764	15 000	18 000
1205EK	25	.9843	52	2.0472	15	.5906	1.0	.039	.28	2.2	3.5	2.5	14 300	3 220	4 000	899	13 000	16 000
1206EK	30	1.1811	62	2.4409	16	.6299	1.0	.039	.25	2.5	3.9	2.5	15 600	3 510	4 650	1 050	10 000	13 000
1207EK	35	1.3780	72	2.8346	17	.6693	1.0	.039	.23	2.7	4.2	2.8	19 000	4 270	6 000	1 350	9 000	11 000
1208EK	40	1.5748	80	3.1496	18	.7087	1.0	.039	.22	2.9	4.5	2.8	19 900	4 470	6 950	1 560	8 500	10 000
1209EK	45	1.7717	85	3.3465	19	.7480	1.0	.039	.21	3	4.6	3.2	22 900	5 150	7 800	1 750	7 500	9 000
1210EK	50	1.9685	90	3.5433	20	.7874	1.0	.039	.21	3	4.6	3.2	26 500	5 960	9 150	2 060	7 000	8 500
1211EK	55	2.1654	100	3.9370	21	.8268	1.5	.059	.19	3.3	5.1	3.6	27 600	6 210	10 600	2 380	6 300	7 500
1212EK	60	2.3622	110	4.3307	22	.8661	1.5	.059	.19	3.3	5.1	3.6	31 200	7 010	12 200	2 740	5 600	6 700
1213EK	65	2.5591	120	4.7244	23	.9055	1.5	.059	.18	3.5	5.4	3.6	35 100	7 890	14 000	3 150	5 300	6 300
1215K	75	2.9528	130	5.1181	25	.9843	1.5	.059	.17	3.7	5.7	4	39 000	8 770	15 600	3 510	4 800	5 600
1216K	80	3.1496	140	5.5118	26	1.0236	2.0	.079	.16	3.9	6.1	4	39 700	8 930	17 000	3 820	4 500	5 300
1217K	85	3.3465	150	5.9055	28	1.1024	2.0	.079	.17	3.7	5.7	4	48 800	11 000	20 800	4 680	4 000	4 800
1218K	90	3.5433	160	6.2992	30	1.1811	2.0	.079	.17	3.7	5.7	4	57 200	12 900	23 600	5 310	3 800	4 500
1219K	95	3.7402	170	6.6929	32	1.2598	2.0	.079	.17	3.7	5.7	4	63 700	14 300	27 000	6 070	3 600	4 300
1220K	100	3.9370	180	7.0866	34	1.3386	2.0	.079	.17	3.7	5.7	4	68 900	15 500	30 000	6 740	3 400	4 000
1221K	105	4.1339	190	7.4803	36	1.4173	2.0	.079	.17	3.7	5.7	4	74 100	16 700	32 500	7 310	3 200	3 800
1222K	110	4.3307	200	7.8740	38	1.4961	2.0	.079	.17	3.7	5.7	4	88 400	19 900	39 000	8 770	3 000	3 600
1224K	120	4.7244	215	8.4646	42	1.6535	2.0	.079	.19	3.3	5.1	3.6	11 900	26 800	53 000	11 900	2 800	3 400
1304EK	20	.7874	52	2.0472	15	.5906	1.0	.039	.28	2.2	3.5	2.5	14 300	3 220	4 000	899	12 000	15 000
1305EK	25	.9843	62	2.4409	17	.6693	1.0	.039	.28	2.2	3.5	2.5	19 000	4 270	5 400	1 210	9 500	12 000
1306EK	30	1.1811	72	2.8346	19	.7480	1.0	.039	.25	2.5	3.9	2.5	22 500	5 060	6 800	1 530	9 000	11 000
1307EK	35	1.3780	80	3.1496	21	.8268	1.5	.059	.25	2.5	3.9	2.5	26 500	5 960	8 500	1 910	7 500	9 000
1308EK	40	1.5748	90	3.5433	23	.9055	1.5	.059	.23	2.7	4.2	2.8	33 800	7 600	11 200	2 520	6 700	8 000
1309EK	45	1.7717	100	3.9370	25	.9843	1.5	.059	.23	2.7	4.2	2.8	39 000	8 770	13 400	3 010	6 300	7 500
1310EK	50	1.9685	110	4.3307	27	1.0630	2.0	.079	.24	2.6	4.1	2.8	43 600	9 800	14 000	3 150	5 600	6 700
1311EK	55	2.1654	120	4.7244	29	1.1417	2.0	.079	.23	2.7	4.2	2.8	50 700	11 400	18 000	4 050	5 000	6 000
1312EK	60	2.3622	130	5.1181	31	1.2205	2.0	.079	.23	2.7	4.2	2.8	58 500	13 200	22 000	4 950	4 500	5 300
1313EK	65	2.5591	140	5.5118	33	1.2992	2.0	.079	.22	2.9	4.5	2.8	65 000	14 600	25 500	5 730	4 300	5 000
1315K	75	2.9528	160	6.2992	37	1.4567	2.0	.079	.22	2.9	4.5	2.8	79 300	17 800	30 000	6 740	3 800	4 500
1316K	80	3.1496	170	6.6929	39	1.5354	2.0	.079	.22	2.9	4.5	2.8	88 400	19 900	33 500	7 530	3 600	4 300
1317K	85	3.3465	180	7.0866	41	1.6142	2.5	.098	.22	2.9	4.5	2.8	97 500	21 900	38 000	8 540	3 400	4 000
1318K	90	3.5433	190	7.4803	43	1.6929	2.5	.098	.22	2.9	4.5	2.8	117 000	26 300	44 000	9 890	3 200	3 800
1319K	95	3.7402	200	7.8740	45	1.7717	2.5	.098	.23	2.7	4.2	2.8	133 000	29 900	51 000	11 500	3 000	3 600
1320K	100	3.9370	215	8.4646	47	1.8504	2.5	.098	.23	2.7	4.2	2.8	143 000	32 200	57 000	12 800	2 800	3 400
1322K	110	4.3307	240	9.4488	50	1.9685	2.5	.098	.22	2.9	4.5	2.8	163 000	36 600	72 000	16 200	2 400	3 000

¹⁾ Fillet radius indicates maximum fillet radius on shaft or in housing which bearing corner will clear.

²⁾ Rating for one million revolutions or 500 hours at 33 1/3 RPM.

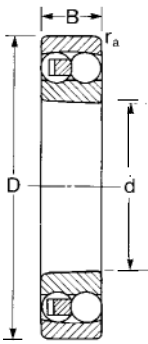

Tapered bore
taper 1:12 on diameter

MRC Bearing Number	Bore		Outside Diameter D		Width B		Fillet Radius ¹⁾ r _a		Calculation Factors				Basic Radial Load Rating				Speed Rating	
									e	Y ₁	Y ₂	Y ₀	Dynamic C _d ²⁾		Static C ₀		Grease RPM	Oil RPM
	d	in	mm	in	mm	in	mm	in					N	lbf	N	lbf		
2205EK	25	.9843	52	2.0472	18	.7087	1.0	.039	.35	1.8	2.8	1.8	16 800	3 780	4 400	989	11 000	14 000
2206EK	30	1.1811	62	2.4409	20	.7874	1.0	.039	.33	1.9	3	2	23 800	5 350	6 700	1 510	9 500	12 000
2207EK	35	1.3780	72	2.8346	23	.9055	1.0	.039	.31	2	3.1	2.2	30 700	6 900	8 800	1 980	8 500	10 000
2208EK	40	1.5748	80	3.1496	23	.9055	1.0	.039	.28	2.2	3.5	2.5	31 900	7 170	10 000	2 250	7 500	9 000
2209EK	45	1.7717	85	3.3465	23	.9055	1.0	.039	.26	2.4	3.7	2.5	32 500	7 310	10 600	2 380	7 000	8 500
2210EK	50	1.9685	90	3.5433	23	.9055	1.0	.039	.23	2.7	4.2	2.8	33 800	7 600	11 200	2 520	6 300	7 500
2211EK	55	2.1654	100	3.9370	25	.9843	1.5	.059	.23	2.7	4.2	2.8	39 000	8 770	13 400	3 010	6 000	7 000
2212EK	60	2.3622	110	4.3307	28	1.1024	1.5	.059	.24	2.6	4.1	2.8	48 800	11 000	17 000	3 820	5 300	6 300
2213EK	65	2.5591	120	4.7244	31	1.2205	1.5	.059	.24	2.6	4.1	2.8	57 200	12 900	20 000	4 500	5 000	6 000
2215K	75	2.9528	130	5.1181	31	1.2205	1.5	.059	.25	2.5	3.9	2.5	44 200	9 940	18 000	4 050	4 500	5 300
2216EK	80	3.1496	140	5.5118	33	1.2992	2.0	.079	.22	2.9	4.5	2.8	65 000	14 600	25 500	5 730	4 000	4 800
2217K	85	3.3465	150	5.9055	36	1.4173	2.0	.079	.25	2.5	3.9	2.5	58 500	13 200	23 600	5 310	3 800	4 500
2218K	90	3.5433	160	6.2992	40	1.5748	2.0	.079	.27	2.3	3.6	2.5	70 200	15 800	28 500	6 410	3 600	4 300
2219K	95	3.7402	170	6.6929	43	1.6929	2.0	.079	.27	2.3	3.6	2.5	83 200	18 700	34 500	7 760	3 400	4 000
2220K	100	3.9370	180	7.0866	46	1.8110	2.0	.079	.27	2.3	3.6	2.5	97 500	21 900	40 500	9 110	3 200	3 800
2221K	105	4.1339	190	7.4803	50	1.9685	2.0	.079	.28	2.2	3.5	2.5	108 000	24 300	45 000	10 100	3 000	3 600
2222K	110	4.3307	200	7.8740	53	2.0866	2.0	.079	.28	2.2	3.5	2.5	124 000	27 900	52 000	11 700	2 800	3 400
2305K	25	.9843	62	2.4409	24	.9449	1.0	.039	.48	1.3	2	1.4	24 200	5 440	6 550	1 470	9 500	12 000
2306K	30	1.1811	72	2.8346	27	1.0630	1.0	.039	.44	1.4	2.2	1.4	31 200	7 010	8 800	1 980	8 500	10 000
2307EK	35	1.3780	80	3.1496	31	1.2205	1.5	.059	.46	1.35	2.1	1.4	39 700	8 930	11 200	2 520	7 000	8 500
2308EK	40	1.5748	90	3.5433	33	1.2992	1.5	.059	.40	1.6	2.4	1.6	54 000	12 100	16 000	3 600	6 300	7 500
2309EK	45	1.7717	100	3.9370	36	1.4173	1.5	.059	.33	1.9	3	2	63 700	14 300	19 300	4 340	5 600	6 700
2310K	50	1.9685	110	4.3307	40	1.5748	2.0	.079	.43	1.5	2.3	1.6	63 700	14 300	20 000	4 500	5 300	6 300
2311K	55	2.1654	120	4.7244	43	1.6929	2.0	.079	.40	1.6	2.4	1.6	76 100	17 100	24 000	5 400	4 800	5 600
2312K	60	2.3622	130	5.1181	46	1.8110	2.0	.079	.33	1.9	3	2	87 100	19 600	28 500	6 410	4 500	5 300
2313K	65	2.5591	140	5.5118	48	1.8898	2.0	.079	.37	1.7	2.6	1.8	95 600	21 500	32 500	7 310	4 000	4 800
2315K	75	2.9528	160	6.2992	55	2.1654	2.0	.079	.37	1.7	2.6	1.8	124 000	27 900	43 000	9 670	3 400	4 000
2316K	80	3.1496	170	6.6929	58	2.2835	2.0	.079	.37	1.7	2.6	1.8	135 000	30 400	49 000	11 000	3 200	3 800
2317K	85	3.3465	180	7.0866	60	2.3622	2.5	.098	.37	1.7	2.6	1.8	140 000	31 500	51 000	11 500	3 000	3 600
2318K	90	3.5433	190	7.4803	64	2.5197	2.5	.098	.37	1.7	2.6	1.8	153 000	34 400	57 000	12 800	2 800	3 400
2319K	95	3.7402	200	7.8740	67	2.6378	2.5	.098	.37	1.7	2.6	1.8	165 000	37 100	64 000	14 400	2 600	3 200
2320K	100	3.9370	215	8.4646	73	2.8740	2.5	.098	.37	1.7	2.6	1.8	190 000	42 700	80 000	18 000	2 400	3 000
2322K	110	4.3307	240	9.4488	80	3.1496	2.5	.098	.37	1.7	2.6	1.8	216 000	48 600	95 000	21 400	2 200	2 800

¹⁾ Fillet radius indicates maximum fillet radius on shaft or in housing which bearing corner will clear.

²⁾ Rating for one million revolutions or 500 hours at 33 1/3 RPM.

1200-K, 1200-EK, 1300-K, 1300-EK Self-Aligning Series with Adapter Sleeve

MRC Bearing Services

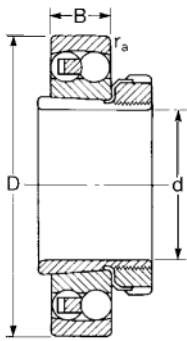

Tapered Bore
Taper 1:12 on Dia.

MRC Bearing Number	Adapter Sleeve	Bore		Outside Diameter D		Width B		Fillet Radius ¹⁾ r _a		Calculation Factors				Basic Radial Load Rating				Speed Rating	
										e	Y ₁	Y ₂	Y ₀	Dynamic C ₂		Static C ₀		Grease RPM	Oil RPM
		mm	in	mm	in	mm	in	mm	in	N	lbf	N	lbf						
1204EK	H204	17	.6693	47	1.8504	14	.5512	1.0	.039	.30	2.1	3.3	2.2	12 700	2 860	3 400	764	15 000	18 000
1205EK	H205	20	.7874	52	2.0472	15	.5906	1.0	.039	.28	2.2	3.5	2.5	14 300	3 220	4 000	899	13 000	16 000
1206EK	H206	25	.9843	62	2.4409	16	.6299	1.0	.039	.25	2.5	3.9	2.5	15 600	3 510	4 650	1 050	10 000	13 000
1207EK	H207	30	1.1811	72	2.8346	17	.6693	1.0	.039	.23	2.7	4.2	2.8	19 000	4 270	6 000	1 350	9 000	11 000
1208EK	H208	35	1.3780	80	3.1496	18	.7087	1.0	.039	.22	2.9	4.5	2.8	19 900	4 470	6 950	1 560	8 500	10 000
1209EK	H209	40	1.5748	85	3.3465	19	.7480	1.0	.039	.21	3	4.6	3.2	22 900	5 150	7 800	1 750	7 500	9 000
1210EK	H210	45	1.7717	90	3.5433	20	.7874	1.0	.039	.21	3	4.6	3.2	26 500	5 960	9 150	2 060	7 000	8 500
1211EK	H211	50	1.9685	100	3.9370	21	.8268	1.5	.059	.19	3.3	5.1	3.6	27 600	6 210	10 600	2 380	6 300	7 500
1212EK	H212	55	2.1654	110	4.3307	22	.8661	1.5	.059	.19	3.3	5.1	3.6	31 200	7 010	12 200	2 740	5 600	6 700
1213EK	H213	60	2.3622	120	4.7244	23	.9055	1.5	.059	.18	3.5	5.4	3.6	35 100	7 890	14 000	3 150	5 300	6 300
1215K	H215	65	2.5591	130	5.1181	25	.9843	1.5	.059	.17	3.7	5.7	4	39 000	8 770	15 600	3 510	4 800	5 600
1216K	H216	70	2.7559	140	5.5118	26	1.0236	2.0	.079	.16	3.9	6.1	4	39 700	8 930	17 000	3 820	4 500	5 300
1217K	H217	75	2.9528	150	5.9055	28	1.1024	2.0	.079	.17	3.7	5.7	4	48 800	11 000	20 800	4 680	4 000	4 800
1218K	H218	80	3.1496	160	6.2992	30	1.1811	2.0	.079	.17	3.7	5.7	4	57 200	12 900	23 600	5 310	3 800	4 500
1219K	H219	85	3.3465	170	6.6929	32	1.2598	2.0	.079	.17	3.7	5.7	4	63 700	14 300	27 000	6 070	3 600	4 300
1220K	H220	90	3.5433	180	7.0866	34	1.3386	2.0	.079	.17	3.7	5.7	4	68 900	15 500	30 000	6 740	3 400	4 000
1221K	H221	95	3.7402	190	7.4803	36	1.4173	2.0	.079	.17	3.7	5.7	4	74 100	16 700	32 500	7 310	3 200	3 800
1222K	H222	100	3.9370	200	7.8740	38	1.4961	2.0	.079	.17	3.7	5.7	4	88 400	19 900	39 000	8 770	3 000	3 600
1224K	H3024	110	4.3307	215	8.4646	42	1.6535	2.0	.079	.19	3.3	5.1	3.6	119 000	26 800	53 000	11 900	2 800	3 400
1304EK	H304	17	.6693	52	2.0472	15	.5906	1.0	.039	.28	2.2	3.5	2.5	14 300	3 220	4 000	899	12 000	14 000
1305EK	H305	20	.7874	62	2.4409	17	.6693	1.0	.039	.28	2.2	3.5	2.5	19 000	4 270	5 400	1 210	9 500	12 000
1306EK	H306	25	.9843	72	2.8346	19	.7480	1.0	.039	.25	2.5	3.9	2.5	25 000	5 060	6 800	1 530	9 000	11 000
1307EK	H307	30	1.1811	80	3.1496	21	.8268	1.5	.059	.25	2.5	3.9	2.5	26 500	5 960	8 500	1 910	7 500	9 000
1308EK	H308	35	1.3780	90	3.5433	23	.9055	1.5	.059	.23	2.7	4.2	2.8	33 800	7 600	11 200	2 520	6 700	8 000
1309EK	H309	40	1.5748	100	3.9370	25	.9843	1.5	.059	.23	2.7	4.2	2.8	39 000	8 770	13 400	3 010	6 300	7 500
1310EK	H310	45	1.7717	110	4.3307	27	1.0630	2.0	.079	.24	2.6	4.1	2.8	43 600	9 800	14 000	3 150	5 600	6 700
1311EK	H311	50	1.9685	120	4.7244	29	1.1417	2.0	.079	.23	2.7	4.2	2.8	50 700	11 400	18 000	4 050	5 000	6 000
1312EK	H312	55	2.1654	130	5.1181	31	1.2205	2.0	.079	.23	2.7	4.2	2.8	58 500	13 200	22 000	4 950	4 500	5 300
1313EK	H313	60	2.3622	140	5.5118	33	1.2992	2.0	.079	.22	2.9	4.5	2.8	65 000	14 600	25 500	5 730	4 300	5 000
1315K	H315	65	2.5591	160	6.2992	37	1.4567	2.0	.079	.22	2.9	4.5	2.8	79 300	17 800	30 000	6 740	3 800	4 500
1316K	H316	70	2.7559	170	6.6929	39	1.5354	2.0	.079	.22	2.9	4.5	2.8	88 400	19 900	33 500	7 530	3 600	4 300
1317K	H317	75	2.9528	180	7.0866	41	1.6142	2.5	.098	.22	2.9	4.5	2.8	97 500	21 900	38 000	8 540	3 400	4 000
1318K	H318	80	3.1496	190	7.4803	43	1.6929	2.5	.098	.22	2.9	4.5	2.8	117 000	26 300	44 000	9 890	3 200	3 800
1319K	H319	85	3.3465	200	7.8740	45	1.7717	2.5	.098	.23	2.7	4.2	2.8	133 000	29 900	51 000	11 500	3 000	3 600
1320K	H320	90	3.5433	215	8.4646	47	1.8504	2.5	.098	.23	2.7	4.2	2.8	143 000	32 200	57 000	12 800	2 800	3 400
1322K	H322	100	3.9370	240	9.4488	50	1.9685	2.5	.098	.22	2.9	4.5	2.8	163 000	36 600	72 000	16 200	2 400	3 000

¹⁾ Fillet radius indicates maximum fillet radius on shaft or in housing which bearing corner will clear.

²⁾ Rating for one million revolutions or 500 hours at 33 1/3 RPM.

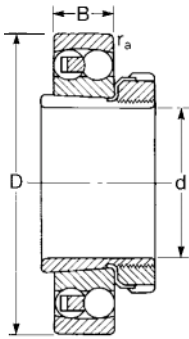

Tapered Bore
Taper 1:12 on Dia.

MRC Bearing Number	Adapter Sleeve	Bore		Outside Diameter D		Width B		Fillet Radius ¹⁾ r _a		Calculation Factors				Basic Radial Load Rating				Speed Rating	
										e	Y ₁	Y ₂	Y ₀	Dynamic C ²⁾		Static C ₀		Grease RPM	Oil RPM
														N	lbf	N	lbf		
2205EK	H305	20	.7874	52	2.0472	18	.7087	1.0	.039	.35	1.8	2.8	1.8	16 800	3 780	4 400	989	11 000	14 000
2206EK	H306	25	.9843	62	2.4409	20	.7874	1.0	.039	.33	1.9	3	2	23 800	5 350	6 700	1 510	9 500	12 000
2207EK	H307	30	1.1811	72	2.8346	23	.9055	1.0	.039	.31	2	3.1	2.2	30 700	6 900	8 800	1 980	8 500	10 000
2208EK	H308	35	1.3780	80	3.1496	23	.9055	1.0	.039	.28	2.2	3.5	2.5	31 900	7 170	10 000	2 250	7 500	9 000
2209EK	H309	40	1.5748	85	3.3465	23	.9055	1.0	.039	.26	2.4	3.7	2.5	32 500	7 310	10 600	2 380	7 000	8 500
2210EK	H310	45	1.7717	90	3.5433	23	.9055	1.0	.039	.23	2.7	4.2	2.8	33 800	7 600	11 200	2 520	6 300	7 500
2211EK	H311	50	1.9685	100	3.9370	25	.9843	1.5	.059	.23	2.7	4.2	2.8	39 000	8 770	13 400	3 010	6 000	7 000
2212EK	H312	55	2.1654	110	4.3307	28	1.1024	1.5	.059	.24	2.6	4.1	2.8	48 800	11 000	17 000	3 820	5 300	6 300
2213EK	H313	60	2.3622	120	4.7244	31	1.2205	1.5	.059	.24	2.6	4.1	2.8	57 200	12 900	20 000	4 500	5 000	6 000
2215K	H315	65	2.5591	130	5.1181	31	1.2205	1.5	.059	.25	2.5	3.9	2.5	44 200	9 940	18 000	4 050	4 500	5 300
2216EK	H316	70	2.7559	140	5.5118	33	1.2992	2.0	.079	.22	2.9	4.5	2.8	65 000	14 600	25 500	5 730	4 000	4 800
2217K	H317	75	2.9528	150	5.9055	36	1.4173	2.0	.079	.25	2.5	3.9	2.5	58 500	13 200	23 600	5 310	3 800	4 500
2218K	H318	80	3.1496	160	6.2992	40	1.5748	2.0	.079	.27	2.3	3.6	2.5	70 200	15 800	28 500	6 410	3 600	4 300
2219K	H319	85	3.3465	170	6.6929	43	1.6929	2.0	.079	.27	2.3	3.6	2.5	83 200	18 700	34 500	7 760	3 400	4 000
2220K	H320	90	3.5433	180	7.0866	46	1.8110	2.0	.079	.27	2.3	3.6	2.5	97 500	21 900	40 500	9 110	3 200	3 800
2221K	H321	95	3.7402	190	7.4803	50	1.9685	2.0	.079	.28	2.2	3.5	2.5	108 000	24 300	45 000	10 100	3 000	3 600
2222K	H322	100	3.9370	200	7.8740	53	2.0866	2.0	.079	.28	2.2	3.5	2.5	124 000	27 900	52 000	11 700	2 800	3 400
2305K	H2305	20	.7874	62	2.4409	24	.9449	1.0	.039	.48	1.3	2	1.4	24 200	5 440	6 550	1 470	9 500	12 000
2306K	H2306	25	.9843	72	2.8346	27	1.0630	1.0	.039	.44	1.4	2.2	1.4	31 200	7 010	8 800	1 980	8 500	10 000
2307EK	H2307	30	1.1811	80	3.1496	31	1.2205	1.5	.059	.46	1.35	2.1	1.4	39 700	8 930	11 200	2 520	7 000	8 500
2308EK	H2308	35	1.3780	90	3.5433	33	1.2992	1.5	.059	.40	1.6	2.4	1.6	54 000	12 100	16 000	3 600	6 300	7 500
2309EK	H2309	40	1.5748	100	3.9370	36	1.4173	1.5	.059	.33	1.9	3	2	63 700	14 300	19 300	4 340	5 600	6 700
2310K	H2310	45	1.7717	110	4.3307	40	1.5748	2.0	.079	.43	1.5	2.3	1.6	63 700	14 300	20 000	4 500	5 300	6 300
2311K	H2311	50	1.9685	120	4.7244	43	1.6929	2.0	.079	.40	1.6	2.4	1.6	76 100	17 100	24 000	5 400	4 800	5 600
2312K	H2312	55	2.1654	130	5.1181	46	1.8110	2.0	.079	.33	1.9	3	2	87 100	19 600	28 500	6 410	4 500	5 300
2313K	H2313	60	2.3622	140	5.5118	48	1.8898	2.0	.079	.37	1.7	2.6	1.8	95 600	21 500	32 500	7 310	4 000	4 800
2315K	H2315	65	2.5591	160	6.2992	55	2.1654	2.0	.079	.37	1.7	2.6	1.8	124 000	27 900	43 000	9 670	3 400	4 000
2316K	H2316	70	2.7559	170	6.6929	58	2.2835	2.0	.079	.37	1.7	2.6	1.8	135 000	30 400	49 000	11 000	3 200	3 800
2317K	H2317	75	2.9528	180	7.0866	60	2.3622	2.5	.098	.37	1.7	2.6	1.8	140 000	31 500	51 000	11 500	3 000	3 600
2318K	H2318	80	3.1496	190	7.4803	64	2.5197	2.5	.098	.37	1.7	2.6	1.8	153 000	34 400	57 000	12 800	2 800	3 400
2319K	H2319	85	3.3465	200	7.8740	67	2.6378	2.5	.098	.37	1.7	2.6	1.8	165 000	37 100	64 000	14 400	2 600	3 200
2320K	H2320	90	3.5433	215	8.4646	73	2.8740	2.5	.098	.37	1.7	2.6	1.8	190 000	42 700	80 000	18 000	2 400	3 000
2322K	H2322	100	3.9370	240	9.4488	80	3.1496	2.5	.098	.37	1.7	2.6	1.8	216 000	48 600	95 000	21 400	2 200	2 800

¹⁾ Fillet radius indicates maximum fillet radius on shaft or in housing which bearing corner will clear.

²⁾ Rating for one million revolutions or 500 hours at 33 1/3 RPM.

**2200 and 2300 Self-Aligning Series with Seals,
and with Seals and Tapered Bore**

MRC Bearing Services

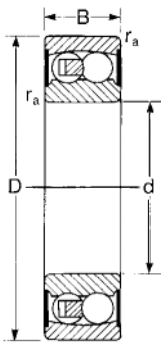

Cylindrical bore

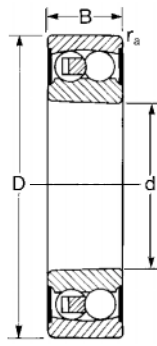

**Tapered bore
taper 1:12 on diameter**

MRC Bearing Number	Bore		Outside Diameter D		Width B		Fillet Radius ¹⁾ r _a		Calculation Factors				Basic Radial Load Rating				Speed Rating
	d mm	in	mm	in	mm	in	mm	in	e	Y ₁	Y ₂	Y ₀	Dynamic C ²⁾		Static C ₀		Grease RPM
													N	lbf	N	lbf	
2200E2RS1	10	.3937	30	1.1811	14	.5512	.60	.024	.33	1.9	3	2	5 530	1 240	1 180	265	17 000
2201E2RS1	12	.4724	32	1.2598	14	.5512	.60	.024	.33	1.9	3	2	6 240	1 400	1 430	321	16 000
2202E2RS1	15	.5906	35	1.3780	14	.5512	.60	.024	.33	1.9	3	2	7 410	1 670	1 760	396	14 000
2203E2RS1	17	.6693	40	1.5748	16	.6299	.60	.024	.31	2	3.1	2.2	8 840	1 990	2 200	495	12 000
2204E2RS1	20	.7874	47	1.8504	18	.7087	1.0	.039	.30	2.1	3.3	2.2	12 700	2 860	3 400	764	10 000
2205E2RS1	25	.9843	52	2.0472	18	.7087	1.0	.039	.28	2.2	3.5	2.5	14 300	3 220	4 000	899	9 000
2206E2RS1	30	1.1811	62	2.4409	20	.7874	1.0	.039	.25	2.5	3.9	2.5	15 600	3 510	4 650	1 050	7 500
2207E2RS1	35	1.3780	72	2.8346	23	.9055	1.0	.039	.23	2.7	4.2	2.8	19 000	4 270	6 000	1 350	6 300
2208E2RS1	40	1.5748	80	3.1496	23	.9055	1.0	.039	.22	2.9	4.5	2.8	19 900	4 470	6 950	1 560	5 600
2209E2RS1	45	1.7717	85	3.3465	23	.9055	1.0	.039	.21	3	4.6	3.2	22 900	5 150	7 800	1 750	5 300
22102RS1	50	1.9685	90	3.5433	23	.9055	1.0	.039	.20	3.2	4.9	3.2	22 900	5 150	8 150	1 830	4 800
2211E2RS1	55	2.1654	100	3.9370	25	.9843	1.5	.059	.19	3.3	5.1	3.6	27 600	6 210	10 600	2 380	4 300
2212E2RS1	60	2.3622	110	4.3307	28	1.1024	1.5	.059	.19	3.3	5.1	3.6	31 200	7 010	12 200	2 740	3 800
2213E2RS1	65	2.5591	120	4.7244	31	1.2205	1.5	.059	.18	3.5	5.4	3.6	35 100	7 890	14 000	3 150	3 600
2214E2RS1	70	2.7559	125	4.9213	31	1.2205	1.5	.059	.18	3.5	5.4	3.6	34 500	7 760	13 700	3 080	3 400
2302E2RS1	15	.5906	42	1.6535	17	.6693	1.0	.039	.31	2	3.1	2.2	10 800	2 430	2 600	585	12 000
2303E2RS1	17	.6693	47	1.8504	19	.7480	1.0	.039	.30	2.1	3.3	2.2	12 700	2 860	3 400	764	11 000
2304E2RS1	20	.7874	52	2.0472	21	.8268	1.0	.039	.28	2.2	3.5	2.5	14 300	3 220	4 000	899	9 500
2305E2RS1	25	.9843	62	2.4409	24	.9449	1.0	.039	.28	2.2	3.5	2.5	19 000	4 270	5 400	1 210	7 500
2306E2RS1	30	1.1811	72	2.8346	27	1.0630	1.0	.039	.25	2.5	3.9	2.5	22 500	5 060	6 800	1 530	6 700
2307E2RS1	35	1.3780	80	3.1496	31	1.2205	1.5	.059	.25	2.5	3.9	2.5	26 500	5 960	8 500	1 910	5 600
2308E2RS1	40	1.5748	90	3.5433	33	1.2992	1.5	.059	.23	2.7	4.2	2.8	33 800	7 600	11 200	2 520	5 000
2309E2RS1	45	1.7717	100	3.9370	36	1.4173	1.5	.059	.23	2.7	4.2	2.8	39 000	8 770	13 400	3 010	4 500
2310E2RS1	50	1.9685	110	4.3307	40	1.5748	2.0	.079	.24	2.6	4.1	2.8	43 600	9 800	14 000	3 150	4 000

Tapered Bore

2205E2RS1K	25	.9843	52	2.0472	18	.7087	1.0	.039	.28	2.2	3.5	2.5	14 300	3 220	4 000	899	9 000
2206E2RS1K	30	1.1811	62	2.4409	20	.7874	1.0	.039	.25	2.5	3.9	2.5	15 600	3 510	4 650	1 050	7 500
2207E2RS1K	35	1.3780	72	2.8346	23	.9055	1.0	.039	.23	2.7	4.2	2.8	19 000	4 270	6 000	1 350	6 300
2208E2RS1K	40	1.5748	80	3.1496	23	.9055	1.0	.039	.22	2.9	4.5	2.8	19 900	4 470	6 950	1 560	5 600
2209E2RS1K	45	1.7717	85	3.3465	23	.9055	1.0	.039	.21	3	4.6	3.2	22 900	5 150	7 800	1 750	5 300
22102RS1K	50	1.9685	90	3.5433	23	.9055	1.0	.039	.20	3.2	4.9	3.2	22 900	5 150	8 150	1 830	4 800
2211E2RS1K	55	2.1654	100	3.9370	25	.9843	1.5	.059	.19	3.3	5.1	3.6	27 600	6 210	10 600	2 380	4 300

¹⁾ Fillet radius indicates maximum fillet radius on shaft or in housing which bearing corner will clear.

²⁾ Rating for one million revolutions or 500 hours at 33 1/3 RPM.

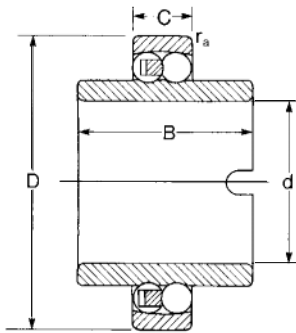

MRC Bearing Number	Bore		Outside Diameter D		Width				Fillet Radius ¹⁾		Calculation Factors				Basic Radial Load Rating				Speed Rating
					C		B				e	Y ₁	Y ₂	Y ₀	Dynamic C _d ²⁾		Static C ₀		Grease or Oil
	d	mm	in	mm	in	mm	in	mm	in	mm	in					N	lbf	N	lbf
11204E	20	.7874	47	1.8504	14	.5512	40	1.575	1.0	.039	.30	2.1	3.3	2.2	12 700	2 860	3 400	764	9 000
11205E	25	.9843	52	2.0472	15	.5906	44	1.732	1.0	.039	.28	2.2	3.5	2.5	14 300	3 220	4 000	899	8 000
11206E	30	1.1811	62	2.4409	16	.6299	48	1.890	1.0	.039	.25	2.5	3.9	2.5	15 600	3 510	4 650	1 050	6 700
11207E	35	1.3780	72	2.8346	17	.6693	52	2.047	1.0	.039	.23	2.7	4.2	2.8	19 000	4 270	6 000	1 350	5 600
11208E	40	1.5748	80	3.1496	18	.7087	56	2.205	1.0	.039	.22	2.9	4.5	2.8	19 900	4 470	6 950	1 560	5 000
11209E	45	1.7717	85	3.3465	19	.7480	58	2.283	1.0	.039	.21	3	4.6	3.2	22 900	5 150	7 800	1 750	4 500
11210E	50	1.9685	90	3.5433	20	.7874	58	2.283	1.0	.039	.21	3	4.6	3.2	26 500	5 960	9 150	2 060	4 300
11212E	60	2.3622	110	4.3307	22	.8661	62	2.441	1.5	.059	.19	3.3	5.1	3.6	31 200	7 010	12 200	2 740	3 400
11305E	25	.9843	62	2.4409	17	.6693	48	1.890	1.0	.039	.28	2.2	3.5	2.5	19 000	4 270	5 400	1 210	6 700
11306E	30	1.1811	72	2.8346	19	.7480	52	2.047	1.0	.039	.25	2.5	3.9	2.5	22 500	5 060	6 800	1 530	5 600
11307E	35	1.3780	80	3.1496	21	.8268	56	2.205	1.5	.059	.25	2.5	3.9	2.5	26 500	5 960	8 500	1 910	5 000
11308E	40	1.5748	90	3.5433	23	.9055	58	2.283	1.5	.059	.23	2.7	4.2	2.8	33 800	7 600	11 200	2 520	4 500
11310E	50	1.9685	110	4.3307	27	1.0630	62	2.441	2.0	.079	.24	2.6	4.1	2.8	43 600	9 800	14 000	3 150	3 600

¹⁾ Fillet radius indicates maximum fillet radius on shaft or in housing which bearing corner will clear.

²⁾ Rating for one million revolutions or 500 hours at 33 1/3 RPM.

Bearings with Cylindrical Bore

Bore Diameter d		C2				Normal				C3				C4					
mm	Over	Including		.001 mm		.0001 in		.001 mm		.0001 in		.001 mm		.0001 in		.001 mm		.0001 in	
	in	mm	in	Min	Max	Min	Max	Min	Max	Min	Max	Min	Max	Min	Max	Min	Max	Min	Max
2.5	.0984	6	.2362	1	8	0	3	5	15	2	6	10	20	4	8	15	25	6	10
6	.2362	10	.3937	2	9	1	4	6	17	2	7	12	25	5	10	19	33	7	13
10	.3937	14	.5512	2	10	1	4	6	19	2	7	13	26	5	10	21	35	8	14
14	.5512	18	.7087	3	12	1	5	8	21	3	8	15	28	6	11	23	37	9	15
18	.7087	24	.9449	4	14	2	6	10	23	4	9	17	30	7	12	25	39	10	15
24	.9449	30	1.1811	5	16	2	6	11	24	4	9	19	35	7	14	29	46	11	18
30	1.1811	40	1.5748	6	18	2	7	13	29	5	11	23	40	9	16	34	53	13	21
40	1.5748	50	1.9685	6	19	2	7	14	31	6	12	25	44	10	17	37	57	15	22
50	1.9685	65	2.5591	7	21	3	8	16	36	6	14	30	50	12	20	45	69	18	27
65	2.5591	80	3.1496	8	24	3	9	18	40	7	16	35	60	14	24	54	83	21	33
80	3.1496	100	3.9370	9	27	4	11	22	48	9	19	42	70	17	28	64	96	25	38
100	3.9370	120	4.7244	10	31	4	12	25	56	10	22	50	83	20	33	75	114	30	45
120	4.7244	140	5.5118	10	38	4	15	30	68	12	27	60	100	24	39	90	135	35	53

Bearings with Tapered Bore

18	.7087	24	.9449	7	17	3	7	13	26	5	10	20	33	8	13	28	42	11	17
24	.9449	30	1.1811	9	20	4	8	15	28	6	11	23	39	9	15	33	50	13	20
30	1.1811	40	1.5748	12	24	5	9	19	35	7	14	26	46	10	18	40	59	16	23
40	1.5748	50	1.9685	14	27	6	11	22	39	9	15	33	52	13	20	45	65	18	26
50	1.9685	65	2.5591	18	32	7	13	27	47	11	19	41	61	16	24	56	80	22	31
65	2.5591	80	3.1496	23	39	9	15	35	57	14	22	50	75	20	30	69	98	27	39
80	3.1496	100	3.9370	29	47	11	19	42	68	17	27	62	90	24	35	84	116	33	46
100	3.9370	120	4.7244	35	56	14	22	50	81	20	32	75	108	30	43	100	139	39	55

Allowable Angular Misalignment of Self-Aligning Ball Bearings

Bearing Series	Allowable Angular Misalignment Degrees
108, 126, 127, 129, 135	3
1200, 1200E	2.5
1300, 1300E	3
1400	3
2200, 2200E	2.5
2200ERS1	1.5
2300, 2300E	3
2300ERS1	1.5
11200E	2.5
11300E	3

Dynamic and static equivalent radial load and life rating

Dynamic equivalent radial load

$$P = F_R + Y_1 F_A, \text{ where } F_A/F_R \leq e$$

or

$$P = 0.65 F_R + Y_2 F_A, \text{ where } F_A/F_R > e$$

P = Dynamic equivalent radial load

F_R = Radial load

F_A = Thrust load

Y_1 = Thrust load factor

Y_2 = Thrust load factor

e = Limiting factor for F_A/F_R

Y_1 , Y_2 and e are given in bearing tables

Life rating

$$L_{10} = \left(\frac{C}{P}\right)^3 \text{ (millions of revolutions)}$$

or

$$L_{10h} = \frac{10^6}{60n} \left(\frac{C}{P}\right)^3 \text{ (Hours)}$$

C = Basic dynamic load rating

P = Dynamic equivalent radial load

n = Speed in RPM

Static equivalent radial load

$$P_0 = F_R + Y_0 F_A$$

P_0 = Static equivalent radial load

F_R = Radial load

F_A = Thrust load

Y_0 = Thrust load factor

Y_0 given in bearing tables

Dynamic equivalent radial load and life calculation examples

Bearing size: 1209E

Speed: 2000 RPM

Basic dynamic radial load rating (C) = 5150

e = 0.21

Y_1 = 3.0

Y_2 = 4.6

Case 1

Radial load (F_R) = 500

Thrust load (F_A) = 100

$F_A/F_R = 100/500 = 0.20$

Equivalent load (P) = $F_R + Y_1 F_A$

$$P = 500 + 3.0 \times 100 = 800$$

$$\text{Life (L}_{10}) = \left(\frac{C}{P}\right)^3 = \left(\frac{5150}{800}\right)^3 = 266.8 \times 10^6 \text{ Rev.}$$

or

$$\begin{aligned} \text{Life (L}_{10h}) &= \frac{10^6}{60n} \left(\frac{C}{P}\right)^3 = \frac{10^6}{60 \times 2000} \left(\frac{5150}{800}\right)^3 \\ &= 2223 \text{ Hrs} \end{aligned}$$

Case 2

Radial load (F_R) = 500

Thrust load (F_A) = 170

$F_A/F_R = 170/500 = 0.34$

Equivalent load (P) = $0.65 F_R + Y_2 F_A$

$$P = 0.65 \times 500 + 4.6 \times 170 = 1107$$

$$\text{Life (L}_{10}) = \left(\frac{C}{P}\right)^3 = \left(\frac{5150}{1107}\right)^3 = 100.7 \times 10^6 \text{ Rev.}$$

or

$$\begin{aligned} \text{Life (L}_{10h}) &= \frac{10^6}{60n} \left(\frac{C}{P}\right)^3 = \frac{10^6}{60 \times 2000} \left(\frac{5150}{1107}\right)^3 \\ &= 839 \text{ Hrs} \end{aligned}$$

Minimum Radial Load For Self-Aligning Ball Bearings

To insure satisfactory operation of self-aligning ball bearings, they must be subjected to a minimum radial load, which is especially true at high speeds where inertia forces of the ball and cage, and the friction in the lubricant, can cause skidding to occur between the balls and raceway.

The required minimum radial load can be estimated from:

$$F_{rm} = K_r \left(\frac{\nu n}{1000} \right)^{2/3} \left(\frac{d_m}{100} \right)^2$$

F_{rm} = minimum radial load (N)
 K_r = minimum load factor

Series	K_r
1400	30
1200E, 1300E, 2200, 11200E, 11300E	40
2200E, 1300 2300E	45 50

ν = oil viscosity at operating temperature (cSt)
 n = speed in rpm
 d_m = mean bearing diameter = $\left(\frac{D + d}{2} \right)$, mm

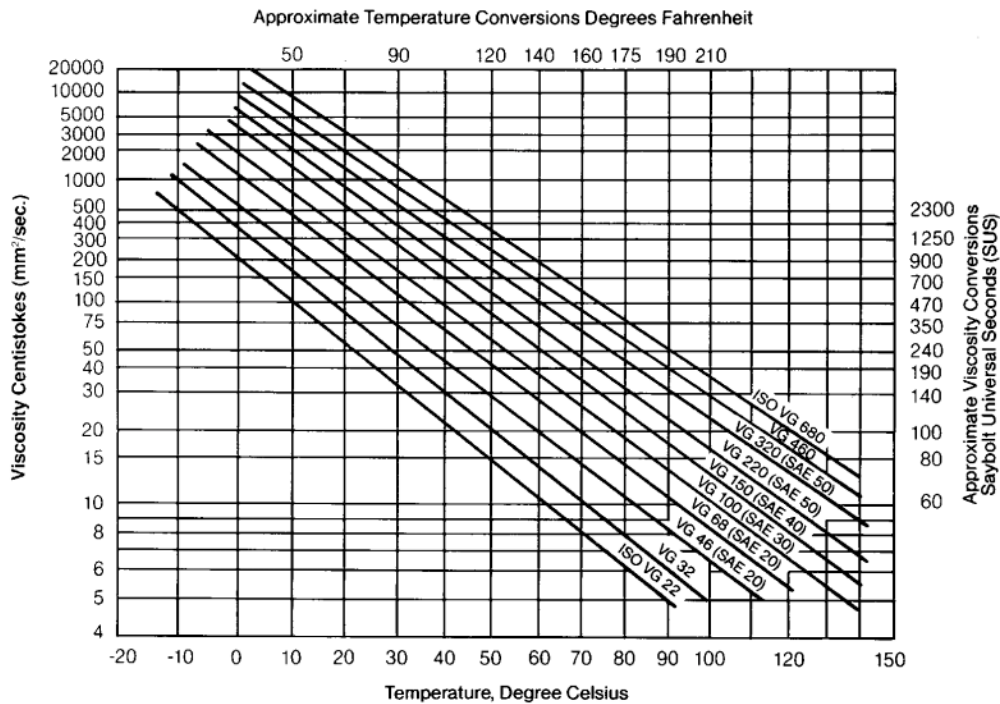
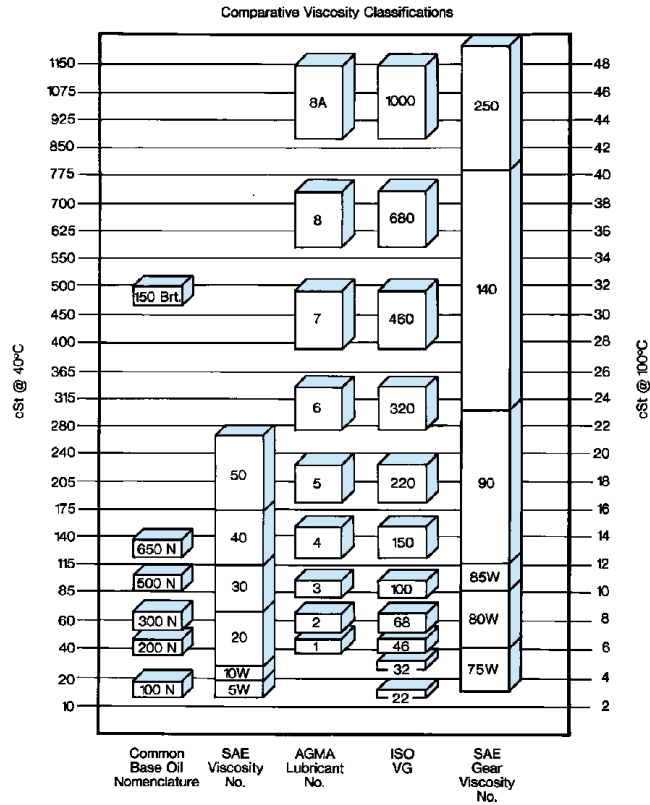

NOTE: Viscosity classification numbers are according to International Standard ISO 3448-1975 for oils having a viscosity index of 95. Approximate equivalent SAE viscosity grades are shown in parentheses.

Ball Protrusion

Self-aligning bearings in Series 1400 and in some sizes in Series 1200, 1200K and 1300K, have ball protrusion beyond the bearing ring faces as shown in the table below. This must be considered when designing adjacent components.

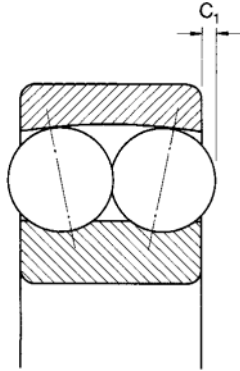

Axial load carrying capacity of bearings mounted on adapter sleeves

The ability of self-aligning ball bearings mounted on adapter sleeves on smooth shafts to carry axial loads, depends on the friction between sleeve and shaft. The approximate permissible axial load can be determined from

$$F_{AP} = 3 B d$$

where, F_{AP} = maximum permissible axial load (N)
 B = bearing width (mm)
 d = bearing bore (mm)

to convert newtons (N) to pounds multiply by 0.2248

Size	Protrusion (C ₁)	
	mm	inches
1224K	1.3	.051
1226	0.7	.028
1318K	1.0	.039
1319K	1.5	.059
1320K	2.5	.098
1321K	2.6	.102
1322K	2.6	.102
1406	2.2	.087
1407	2.0	.079
1408	2.0	.079
1409	2.5	.098
1410	3.0	.118
1411	2.4	.094
1412	2.8	.110

Mounting bearings with tapered bore

Bearings with a tapered bore are always mounted with an interference fit on the shaft, adapter sleeve or withdrawal sleeve. As a measure of the degree of interference of the fit, either the reduction in radial internal clearance of the bearing or the axial displacement of the inner ring on the tapered bearing seating can be used. The mounting of self-aligning ball bearings with tapered bore calls for experience and skill as they have a relatively small internal clearance, and a reliable measurement of the clearance reduction is not always possible.

When mounting bearings with Normal radial internal clearance it is generally sufficient to check clearance reduction during the drive-up by turning and swivelling out the outer ring. When the bearing is properly mounted the outer ring can be easily turned but there should be a slight resistance when the ring is swivelled out. The bearing will then have the requisite interference fit. In some cases, however, the residual internal clearance may be too small for the application, and a bearing with C3 radial internal clearance should be used instead.

When mounting bearings with C3 clearance, the tightening angle α or the axial displacement s can be used to measure the degree of interference. The procedures and values given in the following also apply to bearings with Normal clearance.

An easy method of mounting bearings on adapter sleeves is based on the tightening angle α through which the nut is turned and the procedure is described in the following. Guideline values for the tightening angle α are given in the table overleaf. Before mounting, the thread of the nut and the side face of the nut which is to abut the bearing should be smeared with a molybdenum disulphide paste or similar lubricant, and the outside diameter of the sleeve should be lightly oiled. The bearing is then pushed on to the sleeve and the nut screwed on. By turning the nut through the given angle α the bearing will be pressed up on the tapered seating of the sleeve. As the bearing has a tendency to skew when being pressed up it is advisable to reposition the hook spanner in a slot at 180° to that used for tightening and then apply a light hammer blow to the spanner. The bearing will straighten up on its seating. The nut is then removed, the locking washer inserted and the nut replaced, tightened and locked by bending down one of the tabs of the locking washer. The residual clearance of the bearing should be checked.

Another method which is often used to mount bearings with a tapered bore correctly and reliably is to measure the axial displacement s of the inner ring on the tapered seating. Guideline values for the requisite displacement s are given in the table overleaf.

When using either of the above methods, the self-aligning ball bearings should always be pushed up on to the tapered seating until the bore of the bearing is in contact with the seating on the shaft or sleeve around its whole circumference, before the final tightening procedure is begun. A sufficiently tight fit will then be obtained and the residual clearance will correspond to the mean values given in the table.

One method of measuring the internal clearance of self-aligning ball bearings is shown in the illustrations below. A washer A is inserted between the bearing and the shaft or sleeve nut to ensure correct alignment of the outer ring with respect to the inner ring. A dial gauge B placed on the bearing outer ring can be used to measure the bearing clearance. The outer ring should be pushed upwards in the direction of the shaft.

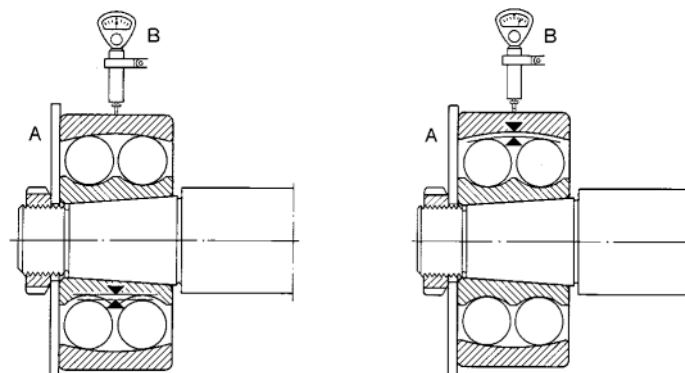

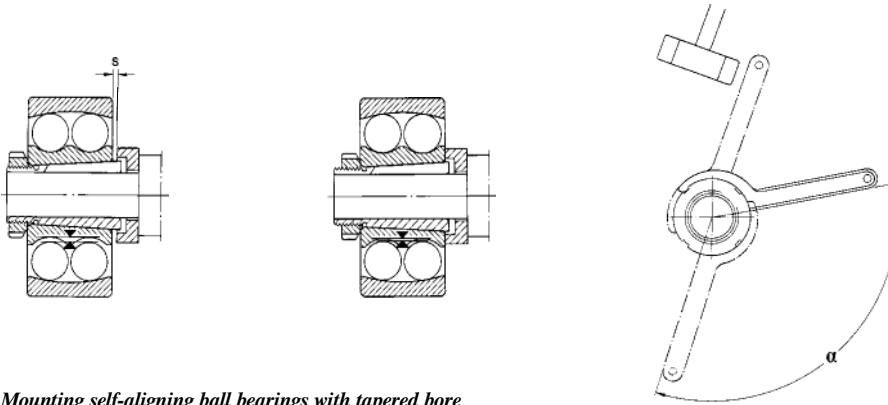

Mounting self-aligning ball bearings with tapered bore

Bearing Bore d	Tightening Angle α	Axial Displacement S								Mean Residual Clearance After Mounting				
		Bearing Series								Normal		C3		
		1200K		1300K		2200K		2300K		.001 mm	.0001 in	.001 mm	.0001 in	
mm	in	Degrees	mm	in	mm	in	mm	in	mm	in	mm	in	mm	in
20	.7874	70	.22	.009	.23	.009	—	—	—	10	4	20	8	
25	.9843	70	.22	.009	.23	.009	.22	.009	.23	10	4	20	8	
30	1.1811	70	.22	.009	.23	.009	.22	.009	.23	10	4	20	8	
35	1.3780	70	.30	.012	.30	.012	.30	.012	.30	10	4	20	8	
40	1.5748	70	.30	.012	.30	.012	.30	.012	.30	10	4	20	8	
45	1.7717	70	.31	.012	.34	.013	.31	.012	.33	15	6	25	10	
50	1.9685	70	.31	.012	.34	.013	.31	.012	.33	15	6	25	10	
55	2.1654	90	.40	.016	.41	.016	.39	.015	.40	15	6	30	12	
60	2.3622	90	.40	.016	.41	.016	.39	.015	.40	15	6	30	12	
65	2.5591	90	.40	.016	.41	.016	.39	.015	.40	15	6	30	12	
75	2.9528	120	.45	.018	.47	.019	.43	.017	.46	20	8	40	16	
80	3.1496	120	.45	.018	.47	.019	.43	.017	.46	20	8	40	16	
85	3.3465	120	.58	.023	.60	.024	.54	.021	.59	20	8	40	16	
90	3.5433	120	.58	.023	.60	.024	.54	.021	.59	20	8	40	16	
95	3.7402	120	.58	.023	.60	.024	.54	.021	.59	20	8	40	16	
100	3.9370	120	.58	.023	.60	.024	.54	.021	.59	20	8	40	16	
105	4.1339	120	.67	.026	—	—	.66	.026	—	25	10	55	22	
110	4.3307	120	.67	.026	.70	.028	.66	.026	.69	25	10	55	22	
120	4.7244	120	.67	.026	—	—	—	—	—	25	10	55	22	

NOTES

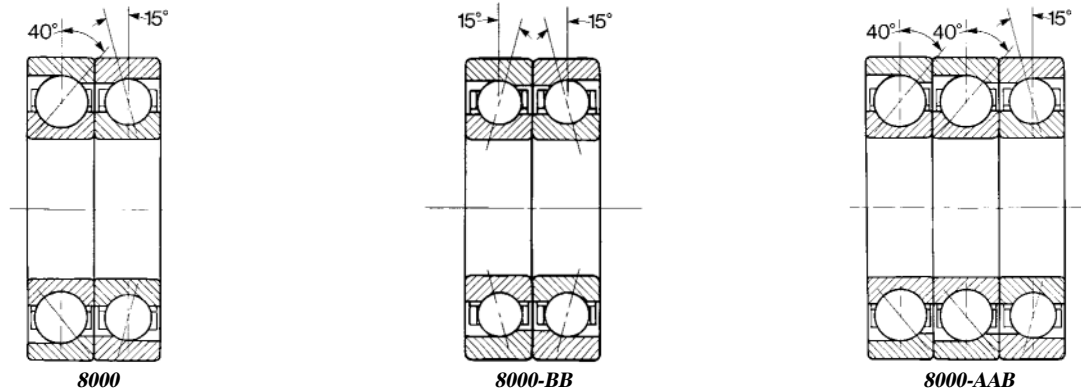

The PumPac 8000 Series consists of a matched set of 40 degree and 15 degree angular contact ball bearings with computer optimized internal design. They are manufactured to ABEC-3 tolerances and are supplied with an inner ring centered machined bronze cage. Also available is the 8000BB PumPac Diamond Series consisting of two 15 degree (B) bearings in a

back-to-back (DB) arrangement, and the 8000AAB Series consisting of two 40 degree (A) bearings in tandem matched back-to-back (DB) with one 15 degree (B) bearing. Each arrangement incorporates a small amount of axial clearance, as clamped, to compensate for mounting fits and thermal growth.

Series	Page
8000 PumPac	177
8000BB PumPac Diamond	178
8000AAB PumPac Triplex Set	179
Equivalent Load and Life	182
Life Calculation Examples	183
Shaft and Housing Fits	180
Mounting Instructions	181

The PumPac 8000 Series is used in centrifugal pumps, large vertical electric motors, compressors, centrifuges, and other applications subject to thrust loads operating at relatively high speeds. The bearings are mounted so that the 40 degree bearing takes the primary thrust, or axial, load.

Traditionally, matched sets of 40 degree angular contact bearings are used to obtain maximum theoretical fatigue life, but in most instances only a fraction of the calculated life is actually achieved. At the heart of these premature failures are phenomena known as “ball sliding” and “ball shuttling” in the unloaded or inactive bearing. Angular contact bearings used in high speed (e.g. 3600 RPM) pumps and other applications require a minimum axial load for proper operation. Without axial load, gyroscopic forces in the unloaded bearing can cause the balls to rotate perpendicular to their true rolling axis and momentarily lose contact with the raceway. As a result, a microscopic wear or lapping process occurs giving the appearance of a burnished or polished raceway. The oil film thickness separating the ball and raceway is reduced producing friction and heat with lower oil viscosity, accelerating wear. This thermally unstable condition dramatically reduces bearing service life.

The main benefit of the PumPac is that the 15 degree bearing is designed with considerably less internal clearance than the 40 degree bearing making it less susceptible to the gyroscopic forces which result in ball sliding or shuttling. This bearing also provides additional radial stiffness helping to maintain integrity of the shaft and mechanical seals. The 40 degree, loaded bearing provides sufficient axial rigidity under the imposed thrust load.

The PumPac is furnished with a one piece, inner ring land guided, machined bronze cage and is manufactured to meet ABEC-3 grade tolerances. Dimensional stability is assured by heat treating for operation up to 375°F (190°C).

For identification purposes the 40 degree bearing is marked with the letter “A” and the 15 degree bearing with the letter “B”. A “V” is etched on the outer ring surface of the set so that the apex falls on the “B” bearing. The set should be mounted so that the “V” points in the same direction as the primary shaft thrust load which places this load on bearing “A”. Any reversing load is carried on bearing “B”.

The PumPac is also available in the 8000BB PumPac Diamond series, which consists of a matched set of 15 degree (B) bearings in a back-to-back arrangement. The marking on the outer ring surface forms a diamond. This series is desirable in high speed, lightly loaded applications in which axial loads are balanced, resulting in reduced operating temperatures and increased life.

For applications involving very heavy primary thrust loads the PumPac may be furnished as a triplex set identified as the 8000AAB Series. It consists of two 40 degree bearings in tandem matched back-to-back (DB) with one 15 degree bearing. The outer ring surface of the set is marked with a “V” pointing in the direction of primary thrust.

For applications having a rotating shaft and stationary housing, an ISO k5 shaft fit and an ISO H6 housing fit is recommended as shown in the table on page 180.

NOTE: The basic radial load rating, C, is calculated according to the actual bearing geometry and not according to ISO/ABMA Standards.

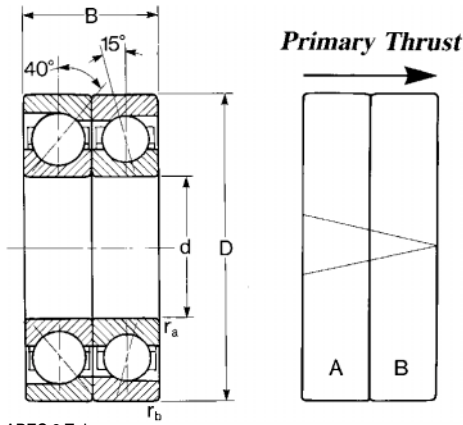

The PumPac 8000 Series consists of one 40° (A) and one 15° (B) bearings.

ABEC 3 Tolerances

MRC Bearing Number	Bore		Outside Diameter		Width		Fillet Radius ¹⁾				Basic Radial Load Rating ²⁾								Speed Rating ³⁾	
	d	in	D	in	B	in	r _a		r _b		40° (A)		15° (B)		Grease	Oil				
							mm	in	mm	in	Dynamic C _d ⁴⁾	Static C _n	Dynamic C _d ⁴⁾	Static C _n						
8218	90	3.5433	160	6.2992	60	2.3622	2.0	.08	1.0	.04	133 000	29 900	143 000	32 100	124 000	27 900	108 000	24 300	3 400	4 500
8219	95	3.7402	170	6.6929	64	2.5197	2.0	.08	1.0	.04	151 000	33 900	163 000	36 600	133 000	29 900	118 000	26 500	3 200	4 300
8220	100	3.9370	180	7.0866	68	2.6772	2.0	.08	1.0	.04	159 000	35 700	173 000	38 900	146 000	32 800	134 000	30 100	3 000	4 000
8222	110	4.3307	200	7.8770	76	2.9921	2.0	.08	1.0	.04	190 000	42 700	220 000	49 500	182 000	40 900	170 000	38 200	2 600	3 600
8224	120	4.7244	215	8.4646	80	3.1496	2.0	.08	1.0	.04	238 000	53 500	245 000	55 100	199 000	44 700	193 000	29 200	2 200	3 200
8238	190	7.4803	340	13.3858	110	4.3307	3.0	.12	1.0	.04	351 000	78 900	570 000	128 000	377 000	84 800	500 000	112 000	1 400	1 900
8308	40	1.5748	90	3.5433	46	1.8110	1.5	.06	1.0	.04	60 500	13 600	45 500	10 200	48 800	11 000	33 500	7 530	6 700	9 000
8309	45	1.7717	100	3.9370	50	1.9685	1.5	.06	1.0	.04	76 100	17 100	61 000	13 700	58 500	13 200	40 500	9 100	6 000	8 000
8310	50	1.9685	110	4.3307	54	2.1260	2.0	.08	1.0	.04	87 100	19 600	72 000	16 200	76 100	17 100	52 000	11 700	5 300	7 000
8311	55	2.1654	120	4.7244	58	2.2845	2.0	.08	1.0	.04	101 000	22 700	85 000	19 100	88 400	19 900	61 000	13 700	4 800	6 300
8312	60	2.3622	130	5.1181	62	2.4409	2.0	.08	1.0	.04	114 000	25 600	96 500	21 700	101 000	22 700	71 000	16 000	4 500	6 000
8313	65	2.5591	140	5.5118	66	2.5984	2.0	.08	1.0	.04	127 000	28 500	112 000	25 200	108 000	24 300	80 000	18 000	4 300	5 600
8314	70	2.7559	150	5.9055	70	2.7559	2.0	.08	1.0	.04	148 000	33 300	134 000	31 500	121 000	27 200	93 000	20 900	3 800	5 000
8315	75	2.9528	160	6.2992	74	2.9134	2.0	.08	1.0	.04	159 000	35 700	150 000	33 700	146 000	32 800	114 000	25 600	3 600	4 800
8316	80	3.1496	170	6.6929	78	3.0709	2.0	.08	1.0	.04	172 000	38 700	166 000	37 300	159 000	35 700	129 000	42 700	3 400	4 500
8317	85	3.3465	180	7.0866	82	3.2283	2.5	.10	1.0	.04	186 000	41 800	186 000	41 800	174 000	39 100	146 000	32 800	3 200	4 300
8318	90	3.5433	190	7.4803	86	3.3858	2.5	.10	1.0	.04	199 000	44 700	204 000	45 900	186 000	41 800	160 000	36 000	3 000	4 000
8319	95	3.7402	200	7.8740	90	3.5433	2.5	.10	1.0	.04	212 000	47 600	228 000	51 300	199 000	44 700	180 000	40 500	2 800	3 800
8320	100	3.9370	215	8.4646	94	3.7008	2.5	.10	1.0	.04	238 000	53 500	270 000	60 700	212 000	47 700	200 000	45 000	2 600	3 600
8322	110	4.3307	240	9.4488	100	3.9370	2.5	.10	1.0	.04	265 000	59 600	320 000	71 900	255 000	57 300	255 000	57 300	2 200	3 200
8326	130	5.1181	280	11.0236	116	4.5669	3.0	.12	1.0	.04	345 000	77 500	455 000	102 000	296 000	66 500	345 000	77 600	1 800	2 600
8330	150	5.9055	320	12.5984	130	5.1181	3.0	.12	1.0	.04	410 000	92 100	585 000	132 000	390 000	87 700	475 000	107 000	1 600	2 200
8336	180	7.0866	380	14.9606	150	5.9055	3.0	.12	1.0	.04	507 000	114 000	815 000	183 000	475 000	107 000	640 000	144 000	1 300	1 600

¹⁾ Fillet radius indicates maximum fillet radius on shaft or in housing which bearing corner will clear.

²⁾ For thrust rating of bearing (A), multiply C by 1.75 and C₀ by 3.85.

For thrust rating of bearing (B), multiply C by 0.83 and C₀ by 2.00.

³⁾ Values have been determined through historical application and practice. For a more complete explanation, see page 276.

⁴⁾ Rating for one million revolutions or 500 hours at 33 1/3 RPM.

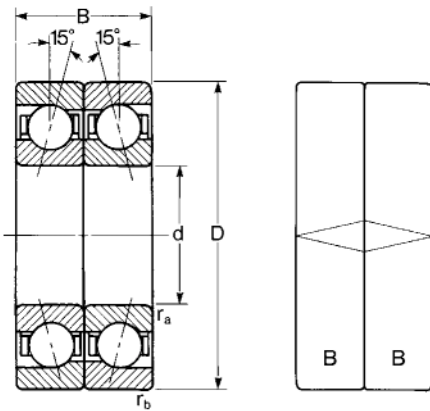

The PumPac 8000-BB series consists of two 15° (B) bearings.

ABEC 3 Tolerances

MRC Bearing Number	Bore		Outside Diameter D		Width B		Fillet Radius ¹⁾				Basic Radial Load Rating ²⁾				Speed Rating ³⁾	
											Dynamic C _d ⁴⁾		Static C ₀		Grease	Oil
	d	mm	in	mm	in	mm	in	mm	in	N	lbf	N	lbf	RPM	RPM	
8218BB	90	3.5433	160	6.2992	60	2.3622	2.0	.08	1.0	.04	203 000	45 600	216 000	48 600	3 800	5 400
8219BB	95	3.7402	170	6.6929	64	2.5197	2.0	.08	1.0	.04	216 000	48 600	236 000	53 100	3 600	5 100
8220BB	100	3.9370	180	7.0866	68	2.6772	2.0	.08	1.0	.04	238 000	53 500	270 000	60 700	3 400	4 800
8222BB	110	4.3307	200	7.8740	70	2.9921	2.0	.08	1.0	.04	296 000	66 500	340 000	76 400	3 000	4 400
8224BB	120	4.7244	215	8.4646	80	3.1496	2.0	.08	1.0	.04	319 000	71 800	390 000	87 700	2 800	4 100
8238BB	190	7.4803	340	13.3858	110	4.3307	3.0	.12	1.0	.04	605 000	136 000	1 000 000	225 000	1 800	2 600
8308BB	40	1.5748	90	3.5433	46	1.8110	1.5	.06	1.0	.04	79 300	17 800	67 000	15 100	7 500	11 000
8309BB	45	1.7717	100	3.9370	50	1.9685	1.5	.06	1.0	.04	95 600	21 500	81 500	18 300	6 800	9 600
8310BB	50	1.9685	110	4.3307	54	2.1260	2.0	.08	1.0	.04	124 000	27 900	104 000	23 400	6 300	9 000
8311BB	55	2.1654	120	4.7244	58	2.2845	2.0	.08	1.0	.04	143 000	32 100	122 000	27 400	5 600	8 100
8312BB	60	2.3622	130	5.1181	62	2.4409	2.0	.08	1.0	.04	165 000	37 100	143 000	32 100	5 000	7 200
8313BB	65	2.5591	140	5.5118	66	2.5984	2.0	.08	1.0	.04	174 000	39 100	160 000	36 000	4 800	6 800
8314BB	70	2.7559	150	5.9055	70	2.7559	2.0	.08	1.0	.04	199 000	44 700	190 000	42 700	4 500	6 300
8315BB	75	2.9528	160	6.2992	74	2.9134	2.0	.08	1.0	.04	238 000	53 500	228 000	51 300	4 300	6 000
8316BB	80	3.1496	170	6.6929	78	3.0709	2.0	.08	1.0	.04	255 000	57 300	260 000	58 500	3 800	5 400
8317BB	85	3.3465	180	7.0866	82	3.2283	2.5	.10	1.0	.04	281 000	63 200	260 000	58 500	3 600	5 100
8318BB	90	3.5433	190	7.4803	86	3.3858	2.5	.10	1.0	.04	302 000	67 900	325 000	73 100	3 400	4 800
8319BB	95	3.7402	200	7.8740	90	3.5433	2.5	.10	1.0	.04	325 000	73 100	360 000	80 900	3 300	4 500
8320BB	100	3.9370	215	8.4646	94	3.7008	2.5	.10	1.0	.04	345 000	77 600	400 000	89 900	3 000	4 400
8322BB	110	4.3307	240	9.4488	100	3.9370	2.5	.10	1.0	.04	416 000	93 500	510 000	115 000	2 600	3 900
8326BB	130	5.1181	280	11.0236	116	4.5669	3.0	.12	1.0	.04	475 000	107 000	695 000	156 000	2 300	3 300
8330BB	150	5.9055	320	12.5984	130	5.1181	3.0	.12	1.0	.04	624 000	140 000	950 000	214 000	2 000	2 900
8336BB	180	7.0866	380	14.9606	150	5.9055	3.0	.12	1.0	.04	780 000	175 000	1 270 000	286 000	1 600	2 400

¹⁾ Fillet radius indicates maximum fillet radius on shaft or in housing which bearing corner will clear.

²⁾ For thrust rating multiply C by 0.51 and C₀ by 1.00.

³⁾ Values have been determined through historical application and practice. For a more complete explanation, see page 276.

⁴⁾ Rating for one million revolutions or 500 hours at 33½ RPM.

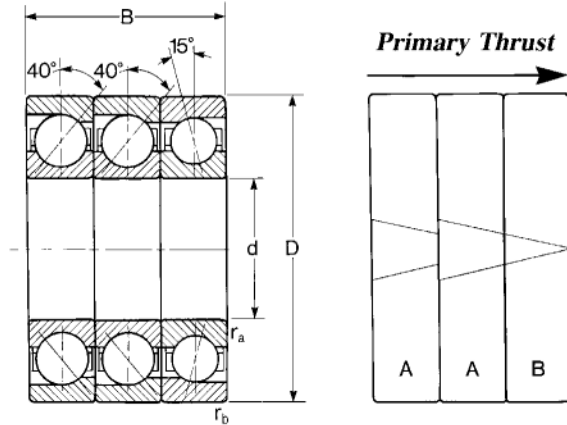

The PumPac 8000-AAB series consists of two 40° (A) and one 15° (B) bearing.

ABEC-3 Tolerances

MRC Bearing Number	Bore		Outside Diameter		Width		Fillet Radius ¹⁾				Basic Radial Load Rating ²⁾				Speed Rating ³⁾					
	d	in	D	in	B	in	r _a		r _b		40° (AA Pair)		15° (B)		Grease RPM	Oil RPM				
							mm	in	mm	in	Dynamic ⁴⁾ C	Static C ₀	Dynamic ⁴⁾ C	Static C ₀						
8218AAB	90	3.5433	160	6.2992	90	3.5433	2.0	.08	1.0	.04	216 000	48 500	285 000	64 100	124 000	27 900	108 000	24 300	3 400	4 500
8219AAB	95	3.7402	170	6.6929	96	3.7795	2.0	.08	1.0	.04	247 000	55 500	325 000	73 100	133 000	29 900	118 000	26 500	3 200	4 300
8220AAB	100	3.9370	180	7.0866	102	4.0157	2.0	.08	1.0	.04	260 000	58 400	345 000	78 700	146 000	32 800	134 000	30 100	3 000	4 000
8222AAB	110	4.3307	200	7.8740	114	4.4882	2.0	.08	1.0	.04	307 000	69 000	440 000	98 900	182 000	40 900	170 000	38 200	2 600	3 600
8224AAB	120	4.7244	215	8.4646	120	4.7244	2.0	.08	1.0	.04	390 000	87 600	490 000	110 000	199 000	44 700	193 000	43 400	2 200	3 200
8238AAB	190	7.4803	340	13.3858	165	6.4961	3.0	.12	1.0	.04	572 000	129 000	1140 000	256 000	377 000	84 800	500 000	112 000	1 400	1 900
8308AAB	40	1.5748	90	3.5433	69	2.7165	1.5	.06	1.0	.04	97 500	21 900	91 500	20 600	48 800	11 000	33 500	7 530	6 700	9 000
8309AAB	45	1.7717	100	3.9370	75	2.9528	1.5	.06	1.0	.04	124 000	27 900	122 000	27 400	58 500	13 200	40 500	9 100	6 000	8 000
8310AAB	50	1.9685	110	4.3307	81	3.1890	2.0	.08	1.0	.04	143 000	32 100	143 000	32 100	76 100	17 100	52 000	11 700	5 300	7 000
8311AAB	55	2.1654	120	4.7244	87	3.4252	2.0	.08	1.0	.04	165 000	37 100	170 000	38 200	88 400	19 900	61 000	13 700	4 800	6 300
8312AAB	60	2.3622	130	5.1181	93	3.6614	2.0	.08	1.0	.04	186 000	41 800	193 000	43 400	101 000	22 700	71 000	16 000	4 500	6 000
8313AAB	65	2.5591	140	5.5118	99	3.8976	2.0	.08	1.0	.04	208 000	46 700	224 000	50 400	108 000	24 300	80 000	18 000	4 300	5 600
8314AAB	70	2.7559	150	5.9055	105	4.1339	2.0	.08	1.0	.04	242 000	54 400	270 000	60 700	121 000	27 200	93 000	20 900	3 800	5 000
8315AAB	75	2.9528	160	6.2992	111	4.3701	2.0	.08	1.0	.04	260 000	58 400	300 000	67 400	146 000	32 800	114 000	25 600	3 600	4 800
8316AAB	80	3.1496	170	6.6929	117	4.6063	2.0	.08	1.0	.04	281 000	63 100	335 000	75 300	159 000	35 700	129 000	42 700	3 400	4 500
8317AAB	85	3.3465	180	7.0866	123	4.8425	2.5	.10	1.0	.04	302 000	67 900	375 000	84 300	174 000	39 100	146 000	32 800	3 200	4 300
8318AAB	90	3.5433	190	7.4803	129	5.0787	2.5	.10	1.0	.04	325 000	73 000	405 000	91 000	186 000	41 800	160 000	36 000	3 000	4 000
8319AAB	95	3.7402	200	7.8740	135	5.3150	2.5	.10	1.0	.04	345 000	77 500	455 000	102 000	199 000	44 700	180 000	40 500	2 800	3 800
8320AAB	100	3.9370	215	8.4646	141	5.5512	2.5	.10	1.0	.04	390 000	87 600	540 000	121 000	212 000	47 700	200 000	45 000	2 600	3 600
8322AAB	110	4.3307	240	9.4488	150	5.9055	2.5	.10	1.0	.04	436 000	98 000	640 000	144 000	255 000	57 300	255 000	57 300	2 200	3 200
8326AAB	130	5.1181	280	11.0236	174	6.8504	3.0	.12	1.0	.04	559 000	126 000	915 000	206 000	296 000	66 500	345 000	77 600	1 800	2 600
8330AAB	150	5.9055	320	12.5984	195	7.6772	3.0	.12	1.0	.04	663 000	149 000	1800 000	265 000	390 000	87 700	475 000	107 000	1 600	2 200
8336AAB	180	7.0866	380	14.9606	225	8.8583	3.0	.12	1.0	.04	824 000	185 000	1630 000	366 000	475 000	107 000	640 000	144 000	1 300	1 600

¹⁾ Fillet radius indicates maximum fillet radius on shaft or in housing which bearing corner will clear.

²⁾ For thrust rating of (AA) multiply C by 1.75 and C₀ by 3.85. For thrust rating of (B) multiply C by 0.83 and C₀ by 2.00.

³⁾ Values have been determined through historical application and practice. For a more complete explanation, see page 276.

⁴⁾ Rating for one million revolutions or 500 hours at 33 1/3 RPM.

MRC Bearing Number	Shaft Diameter (k5)				Fit		Housing Diameter (H6) ¹⁾				Fit	
	Maximum		Minimum		.001	.0001	Maximum		Minimum		.001	.0001
	mm	in	mm	in			mm	in	mm	in		
	mm	in	mm	in	mm	in	mm	in	mm	in	mm	in
8218	90.018	3.5440	90.003	3.5434	3T-33T	1T-13T	160.025	6.3002	160.000	6.2992	0-43L	0-17L
8219	95.018	3.7409	95.003	3.7403	3T-33T	1T-13T	170.025	6.6939	170.000	6.6929	0-43L	0-17L
8220	100.018	3.9377	100.003	3.9371	3T-33T	1T-13T	180.025	7.0876	180.000	7.0866	0-43L	0-17L
8222	110.018	4.3314	110.003	4.3308	3T-33T	1T-13T	200.029	7.8751	200.000	7.8740	0-49L	0-19L
8224	120.018	4.7251	120.003	4.7245	3T-33T	1T-13T	215.029	8.4657	215.000	8.4646	0-49L	0-19L
8238	190.024	7.4812	190.004	7.4805	4T-46T	2T-18T	340.036	13.3872	340.000	13.3858	0-64L	0-25L
8308	40.013	1.5753	40.002	1.5749	2T-23T	1T-9T	90.022	3.5442	90.000	3.5433	0-35L	0-14L
8309	45.013	1.7722	45.002	1.7718	2T-23T	1T-9T	100.022	3.9379	100.000	3.9370	0-35L	0-14L
8310	50.013	1.9690	50.002	1.9686	2T-23T	1T-9T	110.022	4.3316	110.000	4.3307	0-35L	0-14L
8311	55.015	2.1660	55.002	2.1655	2T-27T	1T-11T	120.022	4.7253	120.000	4.7244	0-35L	0-14L
8312	60.015	2.3628	60.002	2.3623	2T-27T	1T-11T	130.025	5.1191	130.000	5.1181	0-40L	0-16L
8313	65.015	2.5597	65.002	2.5592	2T-27T	1T-11T	140.025	5.5128	140.000	5.5118	0-40L	0-16L
8314	70.015	2.7565	70.002	2.7560	2T-27T	1T-11T	150.025	5.9065	150.000	5.9055	0-40L	0-16L
8315	75.015	2.9534	75.002	2.9529	2T-27T	1T-11T	160.025	6.3002	160.000	6.2992	0-43L	0-17L
8316	80.015	3.1502	80.002	3.1497	2T-27T	1T-11T	170.025	6.6939	170.000	6.6929	0-43L	0-17L
8317	85.018	3.3472	85.003	3.3466	3T-33T	1T-13T	180.025	7.0876	180.000	7.0866	0-43L	0-17L
8318	90.018	3.5440	90.003	3.5434	3T-33T	1T-13T	190.029	7.4814	190.000	7.4803	0-49L	0-19L
8319	95.018	3.7409	95.003	3.7403	3T-33T	1T-13T	200.029	7.8751	200.000	7.8740	0-49L	0-19L
8320	100.018	3.9377	100.003	3.9371	3T-33T	1T-13T	215.029	8.4657	215.000	8.4646	0-49L	0-19L
8322	110.018	4.3314	110.003	4.3308	3T-33T	1T-13T	240.029	9.4499	240.000	9.4488	0-49L	0-19L
8326	130.021	5.1189	130.003	5.1182	3T-39T	1T-15T	280.032	11.0247	280.000	11.0236	0-57L	0-21L
8330	150.021	5.9063	150.003	5.9056	3T-39T	1T-15T	320.036	12.5998	320.000	12.5984	0-64L	0-25L
8336	180.021	7.0874	180.003	7.0867	3T-39T	1T-15T	380.036	14.9620	380.000	14.9606	0-64L	0-25L

¹⁾ Cast iron or steel housings. For aluminum or other soft metal housings make housing bore limits same as bearing O.D. limits

PumPac bearings require proper mounting orientation in respect to the direction of the imposed primary thrust load which must be taken on the "A" (40°) bearing. They should be installed so the "V" etched on the O.D. of the bearings points in the direction of the primary shaft thrust load, as illustrated below for PumPac 8000 and 8000 AAB arrangements.

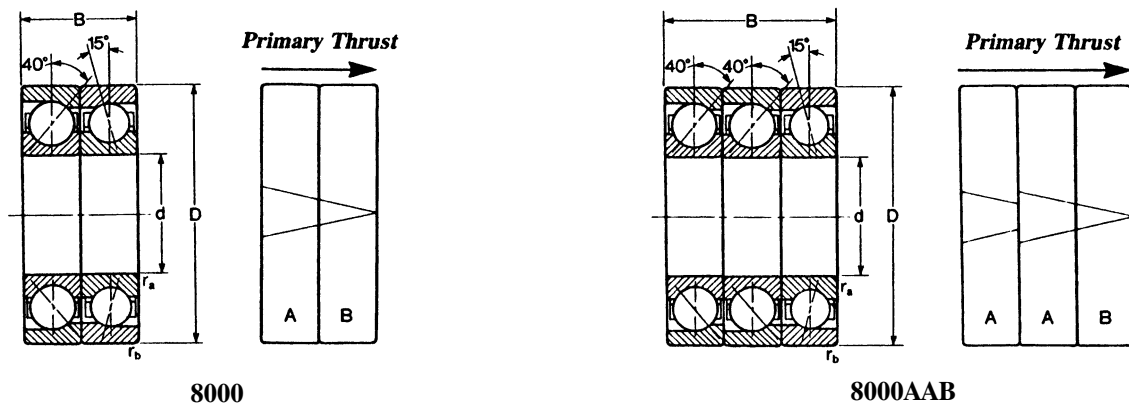

PumPac Dynamic and Static Equivalent Radial Load and Life Rating

MRC Bearing Services

The following method considers only thrust load in either direction with negligible radial load. For combined radial and thrust loads consult MRC Technical Services for analysis.

Dynamic equivalent radial load

Primary thrust on bearing A (40°)

$$P = 0.57 F_A$$

Reversing thrust on bearing B (15°)

$$P = YF_A$$

P = Dynamic equivalent radial load

F_A = Thrust load

Y = Thrust load factor

Z = Number of balls

D = Ball diameter

Life rating

$$L_{10} = \left(\frac{C}{P}\right)^3 \text{ (millions of revolutions)}$$

or

$$L_{10h} = \frac{10^6}{60n} \left(\frac{C}{P}\right)^3 \text{ (Hours)}$$

C = Basic dynamic load rating

P = Dynamic equivalent radial load

n = speed in RPM

Static equivalent radial load

Bearing A (40°)

$$P_0 = 0.26 F_A$$

Bearing B (15°)

$$P_0 = 0.5 F_A$$

P₀ = Static equivalent radial load

F_A = Thrust load

$\frac{F_A}{ZD^2}$		Y
N/mm	Lb/in.	
0.172	25	1.47
0.345	50	1.40
0.689	100	1.30
1.03	150	1.23
1.38	200	1.19
2.07	300	1.12
3.45	500	1.02
5.17	750	1.00
6.89	1 000	1.00

Size	ZD ²		Size	ZD ²		Size	ZD ²	
	mm	inch		mm	inch		mm	inch
8218B	7410	11.5	8310B	3990	6.19	8318B	11800	18.3
8219B	7900	12.3	8311B	4690	7.26	8319B	13100	20.3
8220B	9070	14.1	8312B	5430	8.42	8320B	14400	22.4
8222B	11700	18.1	8313B	5930	9.19	8322B	18900	29.3
8224B	13100	20.3	8314B	6800	10.5	8326B	25700	39.8
8238B	31200	48.4	8315B	8390	13.0	8330B	31500	48.8
8308B	2450	3.80	8316B	9470	14.7	8336B	45700	70.9
8309B	3020	4.69	8317B	10600	16.5			

Values of Y for loads not shown are obtained from chart at right.

Notes: For 8000BB series see page 80.
For combined radial and thrust loads please contact MRC bearing services.

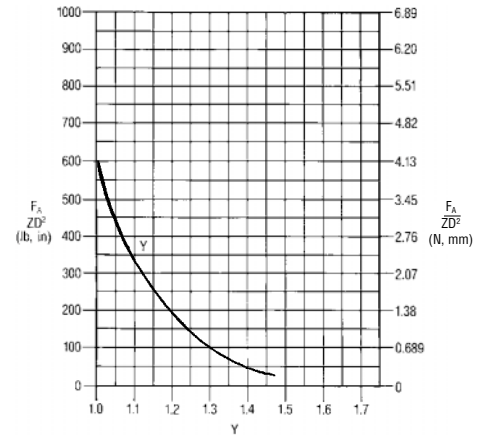

Dynamic equivalent radial load and life calculation examples

PumPac 8000 Series

Bearing size: 8310

Speed: 3500 RPM

Basic dynamic radial load rating (C):

Bearing A = 19600 lbf

Bearing B = 17100 lbf

Bearing A

Primary thrust load (F_A) = 3000

Equivalent load (P) = $0.57 F_A$

$P = 0.57 \times 3000 = 1710$

Life (L10) = $\left(\frac{C}{P}\right)^3 = \left(\frac{19600}{1710}\right)^3 = 1506 \times 10^6$ Rev.

or
Life (L10h) = $\frac{10^6}{60n} \left(\frac{C}{P}\right)^3 = \frac{10^6}{60 \times 3500} \left(\frac{19600}{1710}\right)^3 = 7170$ Hrs

Bearing B

Reversing thrust load (F_A) = 1000

$F_A/ZD^2 = 1000/6.19 = 162$

Equivalent load (P) = $Y F_A$

$Y = 1.22$

$P = 1.22 \times 1000 = 1220$

Life (L10) = $\left(\frac{C}{P}\right)^3 = \left(\frac{17100}{1220}\right)^3 = 2753 \times 10^6$ Rev.

or
Life (L10h) = $\frac{10^6}{60n} \left(\frac{C}{P}\right)^3 = \frac{10^6}{60 \times 3500} \left(\frac{17100}{1220}\right)^3 = 13113$ Hrs

PumPac 8000 AAB Series

Bearing size: 8314 AAB

Speed: 3500 RPM

Basic dynamic radial load rating (C):

Bearings AA = 54400 lbf

Bearing B = 27200 lbf

Bearings AA

Primary thrust load (F_A) = 5000

Equivalent load (P) = $0.57 F_A$

$P = 0.57 \times 5000 = 2850$

Life (L10) = $\left(\frac{C}{P}\right)^3 = \left(\frac{54400}{2850}\right)^3 = 6954 \times 10^6$ Rev.

or
Life (L10h) = $\frac{10^6}{60n} \left(\frac{C}{P}\right)^3 = \frac{10^6}{60 \times 3500} \left(\frac{54400}{2850}\right)^3 = 33116$ Hrs

PumPac Diamond 8000 BB Series

Bearing size: 8317BB

Speed: 3000 RPM

Basic dynamic radial load rating (C):

(Single Bearing) = $\frac{C}{(2)^{0.7}} = \frac{63200}{1.625} = 38890$ lbf

Primary Thrust Bearing

Primary thrust load (F_A) = 2500

$F_A/ZD^2 = 2500/16.5 = 152$

Equivalent load (P) = $Y F_A$

$Y = 1.23$

$P = 1.23 \times 2500 = 3075$

Life (L10) = $\left(\frac{C}{P}\right)^3 = \left(\frac{38890}{3075}\right)^3 = 2023 \times 10^6$ Rev.

or
Life (L10h) = $\frac{10^6}{60n} \left(\frac{C}{P}\right)^3 = \frac{10^6}{60 \times 3000} \left(\frac{38890}{3075}\right)^3 = 11238$ Hrs

Reversing Thrust Bearing

Reversing thrust load (F_A) = 1000

$F_A/ZD^2 = 1000/16.5 = 61$

Equivalent load (P) = $Y F_A$

$Y = 1.38$

$P = 1.238 \times 1000 = 1380$

Life (L10) = $\left(\frac{C}{P}\right)^3 = \left(\frac{38890}{1380}\right)^3 = 22381 \times 10^6$ Rev.

or
Life (L10h) = $\frac{10^6}{60n} \left(\frac{C}{P}\right)^3 = \frac{10^6}{60 \times 3000} \left(\frac{38890}{1380}\right)^3 = 124,340$ Hrs

Bearing B

Reversing thrust load (F_A) = 1500

$F_A/ZD^2 = 1500/10.5 = 143$

Equivalent load (P) = $Y F_A$

$Y = 1.24$

$P = 1.24 \times 1500 = 1860$

Life (L10) = $\left(\frac{C}{P}\right)^3 = \left(\frac{27200}{1860}\right)^3 = 3127 \times 10^6$ Rev.

or
Life (L10h) = $\frac{10^6}{60n} \left(\frac{C}{P}\right)^3 = \frac{10^6}{60 \times 3500} \left(\frac{27200}{1860}\right)^3 = 14900$ Hrs

NOTES

Precision ball bearings in tolerance grades ABEC-5 and ABEC-7 are recommended for applications where high speed and or extreme running accuracy is required. These bearings have the same nominal external dimensions as equivalent size ABEC-1 grade bearings. However, the running characteristics and external dimensions are held to closer tolerances.

Standardization

Bearing envelope dimensions and tolerances shown in this catalog comply with standards established in this country by the Annular Bearing Engineers Committee (ABEC) of the American Bearing Manufacturers Association (ABMA) (see Engineering section; page 241). These standards have also been approved by the American Standard Association (ASA) and the International Standards Organization (ISO). This assures the bearing user of all the advantages of dimensional standardization. However, dimensional interchangeability is not necessarily an indication of functional interchangeability. Other characteristics must also be considered such as cage type, internal clearance or contact angle, configuration of the bearing rings and other details.

In order to meet the running characteristic tolerances specified for precision bearings, it is necessary to assemble them with high precision balls where the size, sphericity and other surface characteristics are held to very close tolerances. Cages generally are of phenolic composition, which is well-suited for high-speed operation.

Temperature

The bearings are manufactured from vacuum-processed 52100 steel that can operate satisfactorily as high as 250°F (121°C). This is well within the requirement of most machine tool applications.

Duplexed Bearings

Precision ball bearings are also duplex ground so they can be used as a component in a pair of bearings or in a bearing set (see Duplex Bearings section; page 236). Duplex pairs or sets of bearings ordered as DB, DF, or DT or in combinations, are tied together as they are to be mounted, then packaged in plastic bags and boxed. DU and DS bearings also are sealed in plastic bags and boxed singularly or in pairs or sets.

Packaging and Identification

Bearings are thoroughly cleaned immediately prior to packaging and are usually coated with a lightweight oil compatible with most machine lubricants. Therefore, bearings can be used as received without being washed, with the oil serving as an initial lubricant. Single-row bearings are packaged in hermetically sealed transparent bags and placed in distinctive boxes identified with bearing number, tolerance grade and other important bearing data.

Size	Series	Page
1900R	Extremely Light, ABEC-7	186
1900RD	Extremely Light, ABEC-7, Duplex Set	187
100KR	Extra Light, ABEC-7, Single Bearing	188
100KRD	Extra Light, ABEC-7, Duplex Set	189
200R	Light, ABEC-7	190
200RD	Light, ABEC-7, Duplex Set	191
300R	Medium, ABEC-7, Single Bearing	192
300RD	Medium, ABEC-7, Duplex Set	193
200S	Light, ABEC-5, Woodworking Bearings	194
300S	Medium, ABEC-5, Woodworking Bearings	194
Ball Screw Supports		195
Excello Bearings		197

Precision 15 Degree Angular Contact 1900-R Extremely Light Series

MRC Bearing Services

Precision 1900-R series angular contact ball bearings are manufactured to meet dimensional and running accuracy to ABEC-7 tolerances. They are supplied with an inner ring-centered phenolic cage designed to minimize centrifugal force.

For recommended mounting fits refer to "Shaft and Housing Fits" in Engineering Data Section.

For equivalent load and life calculations see pages 78 and 79.

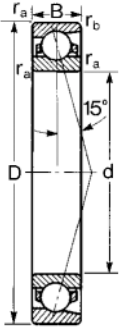

MRC Bearing Number	Bore		Outside Diameter D		Width B		Fillet Radius ¹⁾				Basic Radial Load Rating				Speed Rating ³⁾			
											Dynamic C ²⁾		Static C ₀		Grease	Oil		
	d	mm	in	mm	in	mm	in	r _a	r _b	ZD ²	N	lbf	N	lbf	RPM	RPM		
1900R	10	.3937	22	.8661	6	.2362	.30	.012	.10	.004	110	.17	3 120	701	1 560	351	76 000	110 000
1901R	12	.4724	24	.9449	6	.2362	.30	.012	.10	.004	123	.19	3 250	731	1 800	405	69 000	100 000
1902R	15	.5906	28	1.1024	7	.2756	.30	.012	.10	.004	187	.29	4 880	1 100	2 700	607	55 000	84 000
1903R	17	.6693	30	1.1811	7	.2756	.30	.012	.10	.004	206	.32	5 400	1 210	3 000	674	51 000	78 000
1904R	20	.7874	37	1.4567	9	.3543	.30	.012	.15	.006	400	.62	9 360	2 100	5 850	1 320	41 000	62 000
1905R	25	.9843	42	1.6535	9	.3543	.30	.012	.15	.006	342	.53	7 610	1 710	5 300	1 190	37 000	53 000
1906R	30	1.1811	47	1.8504	9	.3543	.30	.012	.15	.006	452	.70	9 750	2 190	7 100	1 600	32 000	48 000
1907R	35	1.3780	55	2.1654	10	.3937	.64	.025	.15	.006	555	.86	11 200	2 520	9 000	2 020	25 000	39 000
1908R	40	1.5748	62	2.4409	12	.4724	.64	.025	.15	.006	722	1.12	14 300	3 210	11 600	2 600	23 000	36 000
1909R	45	1.7717	68	2.6772	12	.4724	.64	.025	.15	.006	806	1.25	15 100	3 400	13 400	3 010	21 000	31 000
1910R	50	1.9685	72	2.8346	12	.4724	.64	.025	.15	.006	1 070	1.66	19 500	4 380	17 300	3 900	20 000	28 000
1911R	55	2.1654	80	3.1496	13	.5118	1.0	.04	.30	.012	1 260	1.95	22 900	5 150	20 400	4 590	18 000	27 000
1912R	60	2.3622	85	3.3465	13	.5118	1.0	.04	.30	.012	1 390	2.15	24 200	5 440	22 800	5 730	17 000	25 000
1913R	65	2.5591	90	3.5433	13	.5118	1.0	.04	.30	.012	1 450	2.25	24 700	5 550	24 000	5 400	15 000	22 000
1914R	70	2.7559	100	3.9370	16	.6299	1.0	.04	.30	.012	1 990	3.09	33 200	7 460	32 500	7 300	14 000	21 000
1915R	75	2.9528	105	4.1339	16	.6299	1.0	.04	.30	.012	2 080	3.23	34 500	7 760	34 500	7 760	14 000	20 000
1916R	80	3.1496	110	4.3307	16	.6299	1.0	.04	.30	.012	2 180	3.38	34 500	7 760	36 000	8 100	13 000	19 000
1917R	85	3.3465	120	4.7244	18	.7087	1.0	.04	.60	.024	2 840	4.40	44 900	10 100	46 500	10 500	12 000	18 000
1918R	90	3.5433	125	4.9213	18	.7087	1.0	.04	.60	.024	3 400	5.27	52 700	11 800	56 000	12 600	12 000	17 000
1919R	95	3.7402	130	5.1181	18	.7087	1.0	.04	.60	.024	3 090	4.79	47 500	10 700	52 000	11 700	11 000	16 000
1920R	100	3.9370	140	5.5118	20	.7874	1.0	.04	.60	.024	3 870	6.00	58 500	13 200	64 000	14 400	10 000	15 000
1921R	105	4.1329	145	5.7087	20	.7874	1.0	.04	.60	.024	4 030	6.25	60 500	13 600	67 000	15 100	10 000	14 000
1922R	110	4.3307	150	5.9055	20	.7874	1.0	.04	.60	.024	3 820	5.93	55 300	12 400	64 000	14 400	9 200	13 000
1924R	120	4.7244	165	6.4961	22	.8661	1.0	.04	.60	.024	5 100	7.91	74 100	16 700	85 000	19 100	8 300	12 000
1926R	130	5.1181	180	7.0866	24	.9449	1.5	.06	.60	.024	6 300	9.77	90 400	20 500	106 000	23 800	7 800	11 000
1928R	140	5.5118	190	7.4803	24	.9449	1.5	.06	.60	.024	6 580	10.2	95 600	21 400	110 000	24 700	7 400	11 000
1930R	150	5.9055	210	8.2677	28	1.1024	2.0	.08	1.0	.04	9 090	14.1	125 000	28 200	150 000	33 700	6 400	9 500
1932R	160	6.2992	220	8.6614	28	1.1024	2.0	.08	1.0	.04	9 420	14.6	127 000	28 600	156 000	35 100	6 000	9 000
1934R	170	6.6929	230	9.0551	28	1.1024	2.0	.08	1.0	.04	10 200	15.8	133 000	29 800	170 000	38 300	5 500	8 400
1936R	180	7.0866	250	9.8425	33	1.2992	2.0	.08	1.0	.04	12 800	19.9	168 000	36 000	212 000	47 800	5 100	7 800
1938R	190	7.4803	260	10.2362	33	1.2992	2.0	.08	1.0	.04	13 400	20.7	174 000	39 100	224 000	50 400	5 100	7 800
1940R	200	7.8740	280	11.0236	38	1.4961	2.0	.08	1.0	.04	16 800	26.0	216 000	48 600	275 000	61 800	4 600	7 300

¹⁾ Fillet radius indicates maximum fillet radius on shaft or in housing which bearing corner will clear.

²⁾ Rating for one million revolutions or 500 hours at 33 1/3 RPM.

³⁾ Values have been determined through historical application and practice. For a more complete explanation, see pg. 276.

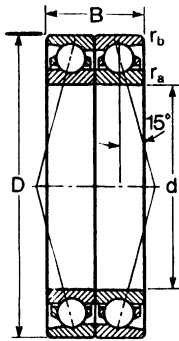

Precision 1900-RD series angular contact ball bearings are manufactured to meet dimensional and running accuracy to ABEC-7 tolerances. They are supplied with an inner ring-centered phenolic cage designed to minimize centrifugal force.

For recommended mounting fits refer to "Shaft and Housing Fits" in Engineering Data Section.

"D" indicates a duplex ground half pair matched with an identical half pair and is followed by an additional suffix letter to describe the type of duplex. See pages 236 and 237 for suffix description.

For equivalent load and life calculations see pages 80 and 81.

Use these values for back-to-back (DB) or face-to-face (DF) mounting arrangements.

MRC Bearing Number	Bore d		Outside Diameter D		Width B		Fillet Radius ¹⁾				Basic Radial Load Rating				Speed Rating ³⁾			
											Dynamic C _d ²⁾		Static C ₀		Grease RPM	Oil RPM		
											N	lbf	N	lbf				
	mm	in	mm	in	mm	in	r _a mm	r _a in	r _b mm	r _b in	ZD ² mm	ZD ² in	N	lbf	N	lbf		
1900RD	10	.3937	22	.8661	12	.4724	.30	.012	.10	.004	110	.17	5 070	1 140	3 100	697	61 000	88 000
1901RD	12	.4724	24	.9449	12	.4724	.30	.012	.10	.004	123	.19	5 270	1 180	3 550	798	55 000	80 000
1902RD	15	.5906	28	1.1024	14	.5512	.30	.012	.10	.004	187	.29	7 930	1 780	5 400	1 210	44 000	67 000
1903RD	17	.6693	30	1.1811	14	.5512	.30	.012	.10	.004	206	.32	8 710	1 960	6 100	1 370	41 000	62 000
1904RD	20	.7874	37	1.4567	18	.7087	.30	.012	.15	.006	400	.62	15 300	3 440	11 600	2 600	33 000	50 000
1905RD	25	.9843	42	1.6535	18	.7087	.30	.012	.15	.006	342	.53	12 400	2 790	10 800	2 430	30 000	42 000
1906RD	30	1.1811	47	1.8504	18	.7087	.30	.012	.15	.006	452	.70	15 900	3 580	14 300	3 210	26 000	38 000
1907RD	35	1.3780	55	2.1654	20	.7874	.64	.025	.15	.006	555	.86	18 200	4 090	18 000	4 050	20 000	31 000
1908RD	40	1.5748	62	2.4409	24	.9449	.64	.025	.15	.006	722	1.12	22 900	5 150	23 200	5 220	18 000	29 000
1909RD	45	1.7717	68	2.6772	24	.9449	.64	.025	.15	.006	806	1.25	24 700	5 550	26 500	5 960	17 000	25 000
1910RD	50	1.9685	72	2.8346	24	.9449	.64	.025	.15	.006	1 070	1.66	31 900	7 170	34 500	7 760	16 000	22 000
1911RD	55	2.1654	80	3.1496	26	1.0236	1.0	.04	.30	.012	1 260	1.95	37 100	8 340	40 500	9 100	14 000	22 000
1912RD	60	2.3622	85	3.3465	26	1.0236	1.0	.04	.30	.012	1 390	2.15	39 000	8 770	45 500	10 200	14 000	20 000
1913RD	65	2.5591	90	3.5433	26	1.0236	1.0	.04	.30	.012	1 450	2.25	39 700	8 920	48 500	10 800	12 000	18 000
1914RD	70	2.7559	100	3.9370	32	1.2598	1.0	.04	.30	.012	1 990	3.09	54 000	12 100	65 500	14 700	11 000	17 000
1915RD	75	2.9528	105	4.1339	32	1.2598	1.0	.04	.30	.012	2 080	3.23	55 900	12 600	68 000	15 300	11 000	16 000
1916RD	80	3.1496	110	4.3307	32	1.2598	1.0	.04	.30	.012	2 180	3.38	57 200	12 900	72 000	16 200	10 000	15 000
1917RD	85	3.3465	120	4.7244	36	1.4173	1.0	.04	.60	.024	2 840	4.40	74 100	16 700	93 000	20 900	9 600	14 000
1918RD	90	3.5433	125	4.9213	36	1.4173	1.0	.04	.60	.024	3 400	5.27	85 200	19 200	112 000	25 200	9 600	14 000
1919RD	95	3.7402	130	5.1181	36	1.4173	1.0	.04	.60	.024	3 090	4.79	76 100	17 100	104 000	23 400	8 800	13 000
1920RD	100	3.9370	140	5.5118	40	1.5748	1.0	.04	.60	.024	3 870	6.00	95 600	21 500	127 000	28 600	8 000	12 000
1921RD	105	4.1329	145	5.7087	40	1.5748	1.0	.04	.60	.024	4 030	6.25	97 500	21 900	134 000	30 100	8 000	11 000
1922RD	110	4.3307	150	5.9055	40	1.5748	1.0	.04	.60	.024	3 820	5.93	90 400	20 300	129 000	29 000	7 400	10 000
1924RD	120	4.7244	165	6.4961	44	1.7323	1.0	.04	.60	.024	5 100	7.91	121 000	27 200	170 000	38 200	6 600	9 600
1926RD	130	5.1181	180	7.0866	48	1.8898	1.5	.06	.60	.024	6 300	9.77	146 000	32 800	208 000	46 800	6 200	8 800
1928RD	140	5.5118	190	7.4803	48	1.8898	1.5	.06	.60	.024	6 580	10.2	156 000	35 100	220 000	49 500	5 900	8 800
1930RD	150	5.9055	210	8.2677	56	2.2047	2.0	.08	1.0	.04	9 090	14.1	203 000	45 600	300 000	67 400	5 100	7 600
1932RD	160	6.2992	220	8.6614	56	2.2047	2.0	.08	1.0	.04	9 420	14.6	208 000	46 800	315 000	70 800	4 800	7 200
1934RD	170	6.6929	230	9.0551	56	2.2047	2.0	.08	1.0	.04	10 200	15.8	216 000	48 600	340 000	76 400	4 400	6 700
1936RD	180	7.0866	250	9.8425	66	2.5984	2.0	.08	1.0	.04	12 800	19.9	276 000	62 000	425 000	95 600	4 100	6 200
1938RD	190	7.4803	260	10.2362	66	2.5984	2.0	.08	1.0	.04	13 400	20.7	281 000	63 200	440 000	98 900	4 100	6 200
1940RD	200	7.8740	280	11.0236	76	2.9921	2.0	.08	1.0	.04	16 800	26.0	351 000	78 900	550 000	124 000	3 700	5 800

¹⁾ Fillet radius indicates maximum fillet radius on shaft or in housing which bearing corner will clear.

²⁾ Rating for one million revolutions or 500 hours at 33 1/3 RPM.

³⁾ Values have been determined through historical application and practice. For a more complete explanation, see pg. 276.

Precision 15 Degree Angular Contact 100-KR Extra Light Series

MRC Bearing Services

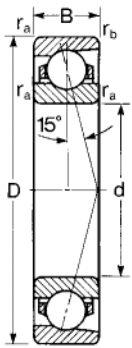

Precision 100-KR series angular contact ball bearings are manufactured to meet dimensional and running accuracy to ABEC-7 tolerances. They are supplied with an inner ring-centered phenolic cage designed to minimize centrifugal force.

For recommended mounting fits refer to "Shaft and Housing Fits" in Engineering Data Section.

For equivalent load and life calculations see pages 78 and 79.

MRC Bearing Number	Bore		Outside Diameter D		Width B		Fillet Radius ¹⁾				ZD ²⁾		Basic Radial Load Rating		Speed Rating ³⁾			
													Dynamic C _d ²⁾		Static C ₀		Grease RPM	Oil RPM
	d	mm	in	mm	in	mm	in	r _a	r _b	mm	in	N	lbf	N	lbf	RPM	RPM	
100KR	10	.3937	26	1.0236	8	.3150	.30	.012	.10	.004	181	.28	4 940	1 110	2 280	513	69 000	100 000
101KR	12	.4724	28	1.1024	8	.3150	.30	.012	.10	.004	206	.32	5 530	1 240	2 650	596	60 000	90 000
102KR	15	.5906	32	1.2598	9	.3543	.30	.012	.10	.004	226	.35	6 050	1 350	3 150	708	51 000	78 000
103KR	17	.6693	35	1.3780	10	.3937	.30	.012	.10	.004	342	.53	8 520	1 920	4 650	1 050	44 000	67 000
104KR	20	.7874	42	1.6535	12	.4724	.60	.024	.30	.012	445	.69	10 800	2 420	6 200	1 390	39 000	56 000
105KR	25	.9843	47	1.8504	12	.4724	.60	.024	.30	.012	522	.81	12 100	2 720	7 650	1 720	35 000	50 000
106KR	30	1.1811	55	2.1654	13	.5118	1.0	.04	.30	.012	716	1.11	15 600	3 500	10 600	2 380	28 000	42 000
107KR	35	1.3780	62	2.4409	14	.5512	1.0	.04	.30	.012	884	1.37	18 600	4 180	13 200	2 970	23 000	36 000
108KR	40	1.5748	68	2.6772	15	.5906	1.0	.04	.30	.012	942	1.46	19 500	4 380	14 600	3 280	22 000	34 000
109KR	45	1.7717	75	2.9528	16	.6299	1.0	.04	.30	.012	1 220	1.89	24 200	5 440	19 000	4 270	21 000	31 000
110KR	50	1.9685	80	3.1496	16	.6299	1.0	.04	.30	.012	1 300	2.01	25 100	5 640	20 400	4 590	20 000	28 000
111KR	55	2.1654	90	3.5433	18	.7087	1.0	.04	.60	.024	1 810	2.81	33 800	7 600	28 000	6 290	17 000	25 000
112KR	60	2.3622	95	3.7402	18	.7087	1.0	.04	.60	.024	1 920	2.97	35 100	7 890	30 000	6 740	15 000	22 000
113KR	65	2.5591	100	3.9370	18	.7087	1.0	.04	.60	.024	2 030	3.14	35 800	8 050	32 500	7 310	14 000	21 000
114KR	70	2.7559	110	4.3307	20	.7874	1.0	.04	.60	.024	2 470	3.83	42 300	9 510	40 000	8 990	14 000	20 000
115KR	75	2.9528	115	4.5276	20	.7874	1.0	.04	.60	.024	2 590	4.02	43 600	9 800	42 500	9 550	13 000	19 000
116KR	80	3.1496	125	4.9212	22	.8661	1.0	.04	.60	.024	3 390	5.25	55 900	12 600	54 000	12 100	12 000	18 000
117KR	85	3.3465	130	5.1181	22	.8661	1.0	.04	.60	.024	3 550	5.50	57 200	12 900	57 000	12 800	12 000	17 000
118KR	90	3.5433	140	5.5118	24	.9449	1.5	.06	.60	.024	4 280	6.64	68 900	15 500	68 000	15 300	11 000	16 000
119KR	95	3.7402	145	5.7087	24	.9449	1.5	.06	.60	.024	5 040	7.81	83 200	18 700	80 000	18 000	10 000	15 000
120KR	100	3.9370	150	5.9055	24	.9449	1.5	.06	.60	.024	4 700	7.28	71 500	16 100	76 500	17 200	10 000	14 000
121KR	105	4.1339	160	6.2992	26	1.0236	2.0	.08	1.0	.04	5 540	8.59	85 200	19 200	90 000	20 200	9 200	13 000
122KR	110	4.3307	170	6.6929	28	1.1024	2.0	.08	1.0	.04	6 400	9.93	99 500	22 400	102 000	23 000	8 700	13 000
124KR	120	4.7244	180	7.0866	28	1.1024	2.0	.08	1.0	.04	6 710	10.4	101 000	22 600	110 000	24 700	7 800	11 000
126KR	130	5.1181	200	7.8740	33	1.2992	2.0	.08	1.0	.04	9 350	14.5	138 000	31 000	150 000	33 700	7 400	11 000
128KR	140	5.5118	210	8.2677	33	1.2992	2.0	.08	1.0	.04	9 350	14.5	135 000	30 300	153 000	34 400	6 900	10 000
130KR	150	5.9055	225	8.8583	35	1.3780	2.0	.08	1.0	.04	10 800	16.8	156 000	35 000	176 000	39 600	6 000	9 000
132KR	160	6.2992	240	9.4488	38	1.4961	2.0	.08	1.0	.04	12 400	19.3	178 000	40 000	204 000	45 900	5 500	8 400
134KR	170	6.6929	260	10.2362	42	1.6535	2.0	.08	1.0	.04	15 300	23.7	212 000	47 700	245 000	55 100	5 100	7 800
136KR	180	7.0866	280	11.0236	46	1.8110	2.0	.08	1.0	.04	17 900	27.8	234 000	52 600	290 000	65 200	4 600	7 300
138KR	190	7.4803	290	11.4173	46	1.8110	2.0	.08	1.0	.04	18 800	29.1	242 000	54 400	305 000	68 600	4 600	7 300
140KR	200	7.8740	310	12.2047	51	2.0079	2.0	.08	1.0	.04	22 200	34.4	276 000	62 000	355 000	79 800	4 400	6 700
144KR	220	8.6614	340	13.3858	56	2.2047	2.5	.10	1.0	.04	30 400	47.2	345 000	77 600	480 000	108 000	4 100	6 200
148KR	240	9.4488	360	14.1732	56	2.2047	2.5	.10	1.0	.04	31 900	49.5	351 000	78 900	510 000	115 000	3 900	5 600

¹⁾ Fillet radius indicates maximum fillet radius on shaft or in housing which bearing corner will clear.

²⁾ Rating for one million revolutions or 500 hours at 33 1/3 RPM.

³⁾ Values have been determined through historical application and practice. For a more complete explanation, see pg. 276.

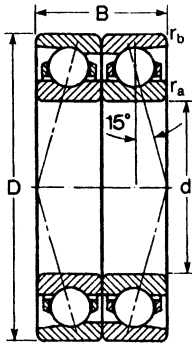

Precision 100-KRD series angular contact ball bearings are manufactured to meet dimensional and running accuracy to ABEC-7 tolerances. They are supplied with an inner ring-centered phenolic cage designed to minimize centrifugal force.

"D" indicates a duplex ground half pair matched with an identical half pair and is followed by an additional suffix letter to describe the type of duplex. See pages 236 and 237 for suffix description.

For equivalent load and life calculations see pages 80 and 81.

Use these values for back-to-back (DB) or face-to-face (DF) mounting arrangements.

MRC Bearing Number	Bore		Outside Diameter D		Width B		Fillet Radius ¹⁾				ZD ²⁾		Basic Radial Load Rating				Speed Rating ³⁾	
													Dynamic C _d ²⁾		Static C ₀		Grease	Oil
	d	mm	in	mm	in	mm	in	r _a	r _b	mm	in	N	lbf	N	lbf	RPM	RPM	
100KRD	10	.3937	26	1.0236	16	.6299	.30	.012	.10	.004	181	.28	8 060	1 810	4 550	1 020	55 000	80 000
101KRD	12	.4724	28	1.1024	16	.6299	.30	.012	.10	.004	206	.32	8 840	1 990	5 300	1 190	48 000	72 000
102KRD	15	.5906	32	1.2598	18	.7087	.30	.012	.10	.004	226	.35	9 750	2 190	6 300	1 420	41 000	62 000
103KRD	17	.6693	35	1.3780	20	.7874	.30	.012	.10	.004	342	.53	13 800	3 100	9 300	2 090	35 000	54 000
104KRD	20	.7874	42	1.6535	24	.9449	.60	.024	.30	.012	445	.69	17 400	3 910	12 500	2 810	31 000	45 000
105KRD	25	.9843	47	1.8504	24	.9449	.60	.024	.30	.012	522	.81	19 500	4 380	15 300	3 440	28 000	40 000
106KRD	30	1.1811	55	2.1654	26	1.0236	1.0	.04	.30	.012	716	1.11	25 500	5 730	21 200	4 760	22 000	34 000
107KRD	35	1.3780	62	2.4409	28	1.1024	1.0	.04	.30	.012	884	1.37	30 200	6 790	26 500	5 960	18 000	29 000
108KRD	40	1.5748	68	2.6772	30	1.1811	1.0	.04	.30	.012	942	1.46	31 900	7 170	29 000	6 520	18 000	27 000
109KRD	45	1.7717	75	2.9528	32	1.2598	1.0	.04	.30	.012	1 220	1.89	39 000	8 770	37 500	8 430	17 000	25 000
110KRD	50	1.9685	80	3.1496	32	1.2598	1.0	.04	.30	.012	1 300	2.01	40 300	9 060	40 500	9 100	16 000	22 000
111KRD	55	2.1654	90	3.5433	36	1.4173	1.0	.04	.60	.024	1 810	2.81	55 300	12 400	56 000	12 600	14 000	20 000
112KRD	60	2.3622	95	3.7402	36	1.4173	1.0	.04	.60	.024	1 920	2.97	55 900	12 600	61 000	13 700	12 000	18 000
113KRD	65	2.5591	100	3.9370	36	1.4173	1.0	.04	.60	.024	2 030	3.14	58 500	13 200	64 000	14 400	11 000	17 000
114KRD	70	2.7559	110	4.3307	40	1.5748	1.0	.04	.60	.024	2 470	3.83	68 900	15 500	80 000	18 000	11 000	16 000
115KRD	75	2.9528	115	4.5276	40	1.5748	1.0	.04	.60	.024	2 590	4.02	70 200	15 800	85 000	19 100	10 000	15 000
116KRD	80	3.1496	125	4.9212	44	1.7323	1.0	.04	.60	.024	3 390	5.25	90 400	20 300	110 000	24 700	9 600	14 000
117KRD	85	3.3465	130	5.1181	44	1.7323	1.0	.04	.60	.024	3 550	5.50	92 300	20 700	116 000	26 100	9 600	14 000
118KRD	90	3.5433	140	5.5118	48	1.8898	1.5	.06	.60	.024	4 280	6.64	111 000	25 000	137 000	30 800	8 800	13 000
119KRD	95	3.7402	145	5.7087	48	1.8898	1.5	.06	.60	.024	5 040	7.81	135 000	30 300	160 000	36 000	8 000	12 000
120KRD	100	3.9370	150	5.9055	48	1.8898	1.5	.06	.60	.024	4 700	7.28	117 000	26 300	153 000	34 400	8 000	11 000
121KRD	105	4.1339	160	6.2992	52	2.0472	2.0	.08	1.0	.04	5 540	8.59	138 000	31 000	180 000	40 500	7 400	10 000
122KRD	110	4.3307	170	6.6929	56	2.2047	2.0	.08	1.0	.04	6 400	9.93	163 000	36 600	204 000	45 900	7 000	10 000
124KRD	120	4.7244	180	7.0866	56	2.2047	2.0	.08	1.0	.04	6 710	10.4	163 000	36 600	220 000	49 500	6 200	8 800
126KRD	130	5.1181	200	7.8740	66	2.5984	2.0	.08	1.0	.04	9 350	14.5	225 000	50 000	300 000	67 400	5 900	8 800
128KRD	140	5.5118	210	8.2677	66	2.5984	2.0	.08	1.0	.04	9 350	14.5	221 000	49 700	305 000	68 600	5 500	8 000
130KRD	150	5.9055	225	8.8583	70	2.7559	2.0	.08	1.0	.04	10 800	16.8	255 000	57 300	355 000	79 800	4 800	7 200
132KRD	160	6.2992	240	9.4488	76	2.9921	2.0	.08	1.0	.04	12 400	19.3	286 000	64 300	405 000	91 000	4 400	6 700
134KRD	170	6.6929	260	10.2362	84	3.3071	2.0	.08	1.0	.04	15 300	23.7	345 000	77 600	490 000	110 000	4 100	6 200
136KRD	180	7.0866	280	11.0236	92	3.6220	2.0	.08	1.0	.04	17 900	27.8	377 000	84 800	570 000	128 000	3 700	5 800
138KRD	190	7.4803	290	11.4173	92	3.6220	2.0	.08	1.0	.04	18 800	29.1	390 000	87 700	610 000	137 000	3 700	5 800
140KRD	200	7.8740	310	12.2047	102	4.0157	2.0	.08	1.0	.04	22 200	34.4	442 000	99 400	710 000	160 000	3 500	5 400
144KRD	220	8.6614	340	13.3858	112	4.4094	2.5	.10	1.0	.04	30 400	47.2	559 000	126 000	965 000	217 000	3 300	5 000
148KRD	240	9.4488	360	14.1732	112	4.4094	2.5	.10	1.0	.04	31 900	49.5	572 000	129 000	1 020 000	228 000	3 100	4 500

¹⁾ Fillet radius indicates maximum fillet radius on shaft or in housing which bearing corner will clear.

²⁾ Rating for one million revolutions or 500 hours at 33 1/3 RPM.

³⁾ Values have been determined through historical application and practice. For a more complete explanation, see pg. 276.

Precision 15 Degree Angular Contact 200-R Light Series

MRC Bearing Services

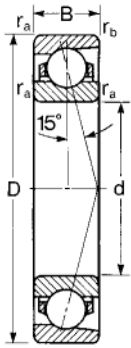

Precision 200-R series angular contact ball bearings are manufactured to meet dimensional and running accuracy to ABEC-7 tolerances. They are supplied with an inner ring centered phenolic cage designed to minimize centrifugal force.

For recommended mounting fits refer to "Shaft and Housing Fits" in engineering data section

For equivalent load and life calculations see pages 78 and 79.

MRC Bearing Number	Bore		Outside Diameter D		Width B		Fillet Radius ¹⁾				ZD ²⁾		Basic Radial Load Rating		Speed Rating ³⁾			
													Dynamic C _d ²⁾		Static C ₀		Grease	Oil
	d	mm	in	mm	in	mm	in	r _a	r _b	mm	in	N	lbf	N	lbf	RPM	RPM	
200R	10	.3937	30	1.1811	9	.3543	.60	.024	.30	.012	284	.44	7 280	1 640	3 200	719	55 000	84 000
201R	12	.4724	32	1.2598	10	.3937	.60	.024	.30	.012	323	.50	8 190	1 840	3 900	877	51 000	78 000
202R	15	.5906	35	1.3780	11	.4331	.60	.024	.30	.012	406	.63	9 750	2 190	5 100	1 150	44 000	67 000
203R	17	.6693	40	1.5748	12	.4724	.60	.024	.30	.012	510	.79	12 100	2 730	6 550	1 470	39 000	56 000
204R	20	.7874	47	1.8504	14	.5512	1.0	.04	.60	.024	562	.87	13 300	2 990	7 800	1 750	35 000	50 000
205R	25	.9843	52	2.0472	15	.5906	1.0	.04	.60	.024	693	1.07	15 900	3 570	9 650	2 170	28 000	42 000
206R	30	1.1811	62	2.4409	16	.6299	1.0	.04	.60	.024	884	1.37	19 000	4 270	12 900	2 910	23 000	36 000
207R	35	1.3780	72	2.8346	17	.6693	1.0	.04	.60	.024	1 270	1.97	26 000	5 850	18 600	4 180	21 000	31 000
208R	40	1.5748	80	3.1496	18	.7087	1.0	.04	.60	.024	1 730	2.68	34 500	7 760	25 000	5 620	20 000	28 000
209R	45	1.7717	85	3.3465	19	.7480	1.0	.04	.60	.024	1 850	2.87	35 800	8 050	27 500	6 180	17 000	25 000
210R	50	1.9685	90	3.5483	20	.7874	1.0	.04	.60	.024	1 970	3.06	37 700	8 480	30 000	6 740	16 000	24 000
211R	55	2.1654	100	3.9370	21	.8268	1.5	.06	1.0	.04	2 860	4.43	54 000	12 100	41 500	9 330	14 000	21 000
212R	60	2.3622	110	4.3307	22	.8661	1.5	.06	1.0	.04	3 260	5.06	59 200	13 300	49 000	11 000	14 000	20 000
213R	65	2.5591	120	4.7244	23	.9055	1.5	.06	1.0	.04	3 780	5.86	58 500	13 200	55 000	12 400	12 000	18 000
214R	70	2.7559	125	4.9213	24	.9449	1.5	.06	1.0	.04	4 030	6.25	71 500	16 100	60 000	13 500	12 000	17 000
215R	75	2.9528	130	5.1181	25	.9842	1.5	.06	1.0	.04	4 880	7.56	85 200	19 200	72 000	16 200	11 000	16 000
216R	80	3.1496	140	5.5118	26	1.0236	2.0	.08	1.0	.04	5 180	8.04	90 400	20 300	78 000	17 500	10 000	15 000
217R	85	3.3465	150	5.9055	28	1.1024	2.0	.08	1.0	.04	6 170	9.56	104 000	23 400	93 000	20 900	10 000	14 000
218R	90	3.5433	160	6.2992	30	1.1811	2.0	.08	1.0	.04	7 410	11.5	124 000	27 900	108 000	24 300	8 700	13 000
219R	95	3.7402	170	6.6929	32	1.2598	2.0	.08	1.0	.04	7 900	12.3	133 000	29 900	118 000	26 500	8 300	12 000
220R	100	3.9370	180	7.0866	34	1.3386	2.0	.08	1.0	.04	9 070	14.1	146 000	32 800	134 000	30 100	7 800	11 000
221R	105	4.1339	190	7.4803	36	1.4173	2.0	.08	1.0	.04	10 300	16.0	168 000	37 800	153 000	34 400	7 400	11 000
222R	110	4.3307	200	7.8740	38	1.4961	2.0	.08	1.0	.04	11 700	18.1	182 000	40 900	170 000	38 200	6 900	10 000
224R	120	4.7244	215	8.4646	40	1.5748	2.0	.08	1.0	.04	13 000	20.2	199 000	44 700	193 000	43 300	6 400	9 500
226R	130	5.1181	230	9.0551	40	1.5748	2.5	.10	1.0	.04	15 500	24.0	221 000	49 600	232 000	52 200	6 000	9 000

¹⁾ Fillet radius indicates maximum fillet radius on shaft or in housing which bearing corner will clear.

²⁾ Rating for one million revolutions or 500 hours at 33 1/3 RPM.

³⁾ Values have been determined through historical application and practice. For a more complete explanation, see pg. 276.

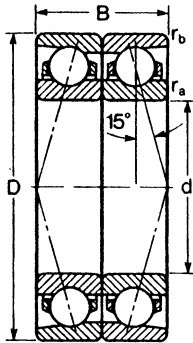

Precision 200-RD series angular contact ball bearings are manufactured to meet dimensional and running accuracy to ABEC-7 tolerances. They are supplied with an inner ring centered phenolic cage designed to minimize centrifugal force.

"D" indicates a duplex ground half pair matched with an identical half pair and is followed by an additional suffix letter to describe the type of duplex. See pages 236 and 237 for suffix description.

For equivalent load and life calculations see pages 80 and 81.

Use these values for back-to-back (DB) or face-to-face (DF) mounting arrangements.

MRC Bearing Number	Bore		Outside Diameter D		Width B		Fillet Radius ¹⁾				Basic Radial Load Rating				Speed Rating ³⁾			
											Dynamic C ²⁾		Static C ₀		Grease	Oil		
	d	mm	in	mm	in	mm	in	r _a	r _b	ZD ²	N	lbf	N	lbf	RPM	RPM		
200RD	10	.3937	30	1.1811	18	.7087	.60	.024	.30	.012	284	.44	11 900	2 680	6 400	1 440	44 000	67 000
201RD	12	.4724	32	1.2598	20	.7874	.60	.024	.30	.012	323	.50	13 300	2 990	7 800	1 750	41 000	62 000
202RD	15	.5906	35	1.3780	22	.8661	.60	.024	.30	.012	406	.63	15 900	3 570	10 200	2 290	35 000	54 000
203RD	17	.6693	40	1.5748	24	.9449	.60	.024	.30	.012	510	.79	19 500	4 380	13 200	2 970	31 000	45 000
204RD	20	.7874	47	1.8504	28	1.1024	1.0	.04	.60	.024	562	.87	21 600	4 860	15 600	3 510	28 000	40 000
205RD	25	.9843	52	2.0472	30	1.1811	1.0	.04	.60	.024	693	1.07	26 000	5 850	19 300	4 340	22 000	34 000
206RD	30	1.1811	62	2.4409	32	1.2598	1.0	.04	.60	.024	884	1.37	30 700	6 900	26 000	5 850	18 000	29 000
207RD	35	1.3780	72	2.8346	34	1.3386	1.0	.04	.60	.024	1 270	1.97	42 600	9 510	37 500	8 430	17 000	25 000
208RD	40	1.5748	80	3.1496	36	1.4173	1.0	.04	.60	.024	1 730	2.68	55 900	12 600	50 000	11 200	16 000	22 000
209RD	45	1.7717	85	3.3465	38	1.4961	1.0	.04	.60	.024	1 850	2.87	58 500	13 200	55 000	12 400	14 000	20 000
210RD	50	1.9685	90	3.5433	40	1.5748	1.0	.04	.60	.024	1 970	3.06	61 800	13 900	60 000	13 500	13 000	19 000
211RD	55	2.1654	100	3.9370	42	1.6535	1.5	.06	1.0	.04	2 860	4.43	87 100	19 600	83 000	18 700	11 000	17 000
212RD	60	2.3622	110	4.3307	44	1.7323	1.5	.06	1.0	.04	3 260	5.06	95 600	21 500	98 000	22 000	11 000	16 000
213RD	65	2.5591	120	4.7244	46	1.8110	1.5	.06	1.0	.04	3 780	5.86	95 600	21 500	110 000	24 700	9 600	14 000
214RD	70	2.7559	125	4.9213	48	1.8998	1.5	.06	1.0	.04	4 030	6.25	117 000	26 300	120 000	27 000	9 600	14 000
215RD	75	2.9528	130	5.1181	50	1.9685	1.5	.06	1.0	.04	4 880	7.56	138 000	31 000	148 000	32 100	8 800	13 000
216RD	80	3.1496	140	5.5118	52	2.0472	2.0	.08	1.0	.04	5 180	8.04	153 000	34 400	156 000	35 100	8 000	12 000
217RD	85	3.3465	150	5.9055	56	2.2047	2.0	.08	1.0	.04	6 170	9.56	168 000	37 800	186 000	41 800	8 000	11 000
218RD	90	3.5433	160	6.2992	60	2.3622	2.0	.08	1.0	.04	7 410	11.5	203 000	45 600	216 000	48 600	7 000	10 000
219RD	95	3.7402	170	6.6929	64	2.5197	2.0	.08	1.0	.04	7 900	12.3	216 000	48 600	236 000	53 100	6 600	9 600
220RD	100	3.9370	180	7.0866	68	2.6772	2.0	.08	1.0	.04	9 070	14.1	238 000	53 500	270 000	60 700	6 200	8 800
221RD	105	4.1339	190	7.4803	72	2.8346	2.0	.08	1.0	.04	10 300	16.0	270 000	60 700	305 000	68 600	5 900	8 800
222RD	110	4.3307	200	7.8740	76	2.9921	2.0	.08	1.0	.04	11 700	18.1	296 000	66 500	340 000	76 400	5 500	8 000
224RD	120	4.7244	215	8.4646	80	3.1496	2.0	.08	1.0	.04	13 000	20.2	325 000	73 100	390 000	87 700	5 100	7 600
226RD	130	5.1181	230	9.0551	80	3.1496	2.5	.10	1.0	.04	15 500	24.0	358 000	80 500	465 000	105 000	4 800	7 200

¹⁾ Fillet radius indicates maximum fillet radius on shaft or in housing which bearing corner will clear.

²⁾ Rating for one million revolutions or 500 hours at 33 1/3 RPM.

³⁾ Values have been determined through historical application and practice. For a more complete explanation, see pg. 276.

Precision 15 Degree Angular Contact 300-R Medium Series

MRC Bearing Services

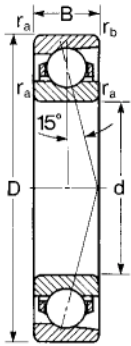

Precision 300-R series angular contact ball bearings are manufactured to meet dimensional and running accuracy to ABEC-7 tolerances. They are supplied with an inner ring centered phenolic cage designed to minimize centrifugal force.

For recommended mounting fits refer to "Shaft and Housing Fits" in Engineering Data Section.

For equivalent load and life calculations see pages 78 and 79.

MRC Bearing Number	Bore		Outside Diameter D		Width B		Fillet Radius ¹⁾				ZD ²⁾		Basic Radial Load Rating		Speed Rating ³⁾				
													Dynamic C ²⁾		Static C ₀		Grease	Oil	
	d	mm	in	mm	in	mm	in	mm	in	mm	in	N	lbf	N	lbf	RPM	RPM		
300R	10		.3937	35	1.3780	11	.4331	1.0	.04	.60	.024	439	.68	10 500	2 360	4 550	1 020	46 000	73 000
301R	12		.4724	37	1.4567	12	.4724	1.0	.04	.60	.024	439	.68	10 600	2 380	4 900	1 100	44 000	67 000
302R	15		.5906	42	1.6535	13	.5118	1.0	.04	.60	.024	510	.79	12 100	2 720	6 550	1 470	39 000	56 000
303R	17		.6693	47	1.8504	14	.5512	1.0	.04	.60	.024	632	.98	14 800	3 330	8 150	1 830	37 000	53 000
304R	20		.7874	52	2.0472	15	.5906	1.0	.04	.60	.024	909	1.41	20 300	4 560	11 400	2 560	30 000	45 000
305R	25		.9843	62	2.4409	17	.6693	1.0	.04	.60	.024	1 090	1.69	23 400	5 260	15 300	3 440	25 000	39 000
306R	30		1.1811	72	2.8346	19	.7480	1.0	.04	.60	.024	1 480	2.30	31 200	7 010	20 000	4 500	21 000	31 000
307R	35		1.3780	80	3.1496	21	.8268	1.5	.06	1.0	.04	1 940	3.00	39 700	8 920	26 000	5 850	20 000	28 000
308R	40		1.5748	90	3.5433	23	.9055	1.5	.06	1.0	.04	2 450	3.80	48 800	11 000	33 500	7 530	17 000	25 000
309R	45		1.7717	100	3.9370	25	.9843	1.5	.06	1.0	.04	3 030	4.69	58 500	13 200	40 500	9 100	15 000	22 000
310R	50		1.9685	110	4.3307	27	1.0630	2.0	.08	1.0	.04	3 990	6.19	76 100	17 100	52 000	11 700	14 000	21 000
311R	55		2.1654	120	4.7244	29	1.1417	2.0	.08	1.0	.04	4 690	7.26	88 400	19 900	61 000	13 700	13 000	19 000
312R	60		2.3622	130	5.1181	31	1.2205	2.0	.08	1.0	.04	5 430	8.42	101 000	22 700	71 000	16 000	12 000	17 000
313R	65		2.5591	140	5.5118	33	1.2992	2.0	.08	1.0	.04	5 930	9.19	108 000	24 300	80 000	18 000	11 000	16 000
314R	70		2.7559	150	5.9055	35	1.3780	2.0	.08	1.0	.04	6 770	10.5	121 000	27 200	93 000	20 900	10 000	15 000
315R	75		2.9528	160	6.2992	37	1.4567	2.0	.08	1.0	.04	8 390	13.0	146 000	32 800	114 000	25 600	9 900	14 000
316R	80		3.1496	170	6.6929	39	1.5354	2.0	.08	1.0	.04	9 480	14.7	159 000	35 700	129 000	29 000	8 700	13 000
317R	85		3.3465	180	7.0866	41	1.6142	2.5	.10	1.0	.04	10 600	16.5	174 000	39 100	146 000	32 800	8 300	12 000
318R	90		3.5433	190	7.4803	43	1.6929	2.5	.10	1.0	.04	11 800	18.3	186 000	41 800	160 000	36 000	7 800	11 000
319R	95		3.7402	200	7.8740	45	1.7717	2.5	.10	1.0	.04	13 100	20.3	199 000	44 700	180 000	40 500	7 400	11 000
320R	100		3.9370	215	8.4646	47	1.8504	2.5	.10	1.0	.04	14 400	22.4	212 000	47 700	200 000	45 000	6 900	10 000
321R	105		4.1339	225	8.8583	49	1.9291	2.5	.10	1.0	.04	15 900	24.6	229 000	51 500	204 000	45 900	6 400	9 500
322R	110		4.3307	240	9.4488	50	1.9685	2.5	.10	1.0	.04	18 800	29.2	255 000	57 300	255 000	57 300	6 000	9 000
324R	120		4.7244	260	10.2362	55	2.1654	2.5	.10	1.0	.04	22 100	34.3	265 000	59 600	300 000	67 400	5 800	8 400
326R	130		5.1181	280	11.0236	58	2.2835	3.0	.12	1.0	.04	25 700	39.8	296 000	66 500	345 000	77 600	5 300	7 800

¹⁾ Fillet radius indicates maximum fillet radius on shaft or in housing which bearing corner will clear.

²⁾ Rating for one million revolutions or 500 hours at 33 1/3 RPM.

³⁾ Values have been determined through historical application and practice. For a more complete explanation, see pg. 276.

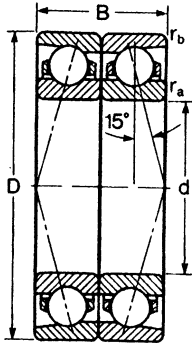

Precision 300-RD series angular contact ball bearings are manufactured to meet dimensional and running accuracy to ABEC-7 tolerances. They are supplied with an inner ring centered phenolic cage designed to minimize centrifugal force.

For recommended mounting fits refer to "Shaft and Housing Fits" in Engineering Data Section.

"D" indicates a duplex ground half pair matched with an identical half pair and is followed by an additional suffix letter to describe the type of duplex. See pages 236 and 237 for suffix description.

For equivalent load and life calculations see pages 80 and 81.

Use these values for back-to-back (DB) or face-to-face (DF) mounting arrangements.

MRC Bearing Number	Bore		Outside Diameter D		Width B		Fillet Radius ¹⁾				Basic Radial Load Rating				Speed Rating ³⁾			
											Dynamic C _d ²⁾		Static C ₀		Grease RPM	Oil RPM		
											N	lbf	N	lbf				
	mm	in	mm	in	mm	in	r _a mm	r _a in	r _b mm	r _b in	ZD ²⁾ mm	ZD ²⁾ in	N	lbf	N	lbf		
300RD	10	.3937	35	1.3780	22	.8661	1.0	.04	.60	.024	439	.68	17 200	3 870	9 150	2 060	37 000	58 000
301RD	12	.4724	37	1.4567	24	.9449	1.0	.04	.60	.024	439	.68	17 200	3 870	9 800	2 200	35 000	54 000
302RD	15	.5906	42	1.6535	26	1.0236	1.0	.04	.60	.024	510	.79	19 500	4 380	13 200	2 970	31 000	45 000
303RD	17	.6693	47	1.8504	28	1.1024	1.0	.04	.60	.024	632	.98	24 200	5 440	16 300	3 660	30 000	42 000
304RD	20	.7874	52	2.0472	30	1.1811	1.0	.04	.60	.024	909	1.41	33 200	7 460	22 800	5 130	24 000	36 000
305RD	25	.9843	62	2.4409	34	1.3386	1.0	.04	.60	.024	1 090	1.69	37 700	8 480	30 500	6 860	20 000	31 000
306RD	30	1.1811	72	2.8346	38	1.4961	1.0	.04	.60	.024	1 480	2.30	52 000	11 700	40 000	8 990	17 000	25 000
307RD	35	1.3780	80	3.1496	42	1.6535	1.5	.06	1.0	.04	1 940	3.00	65 000	14 600	52 000	11 700	16 000	22 000
308RD	40	1.5748	90	3.5433	46	1.8110	1.5	.06	1.0	.04	2 450	3.80	79 300	17 800	67 000	15 100	14 000	20 000
309RD	45	1.7717	100	3.9370	50	1.9685	1.5	.06	1.0	.04	3 030	4.69	95 600	21 500	81 500	18 300	12 000	18 000
310RD	50	1.9685	110	4.3307	54	2.1260	2.0	.08	1.0	.04	3 990	6.19	124 000	27 900	104 000	23 400	11 000	17 000
311RD	55	2.1654	120	4.7244	58	2.2835	2.0	.08	1.0	.04	4 690	7.26	143 000	32 100	122 000	27 400	10 000	15 000
312RD	60	2.3622	130	5.1181	62	2.4409	2.0	.08	1.0	.04	5 430	8.42	165 000	37 100	143 000	32 100	9 600	14 000
313RD	65	2.5591	140	5.5118	66	2.5984	2.0	.08	1.0	.04	5 930	9.19	174 000	39 100	160 000	36 000	8 800	13 000
314RD	70	2.7559	150	5.9055	70	2.7559	2.0	.08	1.0	.04	6 770	10.5	195 000	43 800	186 000	41 800	8 000	12 000
315RD	75	2.9528	160	6.2992	74	2.9134	2.0	.08	1.0	.04	8 390	13.0	238 000	53 500	228 000	51 300	8 000	11 000
316RD	80	3.1496	170	6.6929	78	3.0709	2.0	.08	1.0	.04	9 480	14.7	260 000	58 500	260 000	58 500	7 000	10 000
317RD	85	3.3465	180	7.0866	82	3.2283	2.5	.10	1.0	.04	10 600	16.5	281 000	63 200	290 000	65 200	6 600	9 600
318RD	90	3.5433	190	7.4803	86	3.3858	2.5	.10	1.0	.04	11 800	18.3	302 000	67 900	320 000	71 900	6 200	8 800
319RD	95	3.7402	200	7.8740	90	3.5433	2.5	.10	1.0	.04	13 100	20.3	325 000	73 100	360 000	80 900	5 900	8 800
320RD	100	3.9370	215	8.4646	94	3.7008	2.5	.10	1.0	.04	14 400	22.4	345 000	77 600	400 000	89 900	5 500	8 000
321RD	105	4.1339	225	8.8583	98	3.8583	2.5	.10	1.0	.04	15 900	24.6	371 000	83 400	405 000	91 000	5 100	7 600
322RD	110	4.3307	240	9.4488	100	3.9370	2.5	.10	1.0	.04	18 800	29.2	416 000	93 500	510 000	115 000	4 800	7 200
324RD	120	4.7244	260	10.2362	110	4.3307	2.5	.10	1.0	.04	22 100	34.3	436 000	98 000	600 000	135 000	4 600	6 700
326RD	130	5.1181	280	11.0236	116	4.5669	3.0	.12	1.0	.04	25 700	39.8	475 000	107 000	695 000	156 000	4 200	6 200

¹⁾ Fillet radius indicates maximum fillet radius on shaft or in housing which bearing corner will clear.

²⁾ Rating for one million revolutions or 500 hours at 33 1/3 RPM.

³⁾ Values have been determined through historical application and practice. For a more complete explanation, see pg. 276.

General Information

Ball Bearings manufactured specifically for the woodworking industry often carry special specifications in order to meet the requirements of both high speed and accuracy. As a result of actively participating in this market for many years, MRC has designed a line of deep groove ball bearings that meet the special needs of the woodworking industry. They are high precision bearings with carefully

controlled internal characteristics, providing very good shaft rigidity and precise control of axial and radial runout.

The bearings are available with bakelite (phenolic), pressed brass, or glass reinforced polyamide cages, as illustrated below.

Recommended mounting fits are shown on pages 260 to 261 in the shaft and housing fit section.

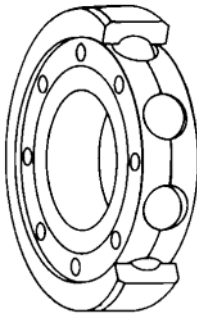

Bakelite

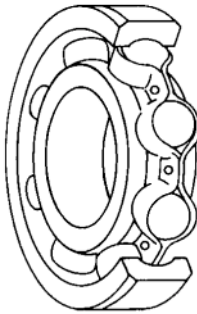

Brass

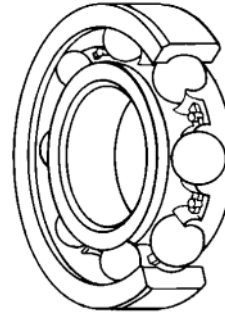

polyamide

Bearing Identification

Example of marking on MRC Bearing Box
207S-BRS#5 CO

Identification of Marking

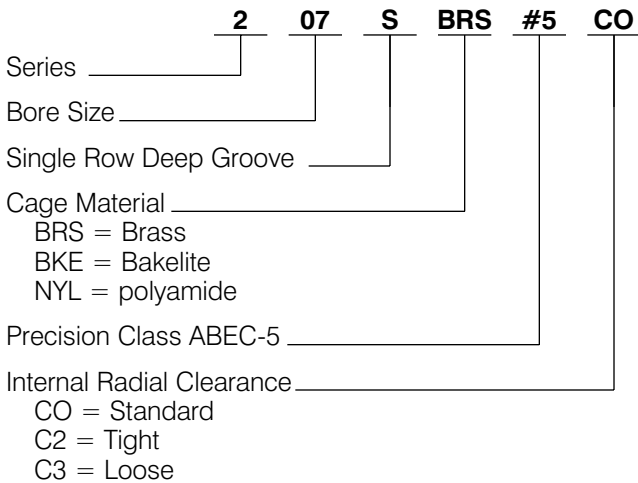

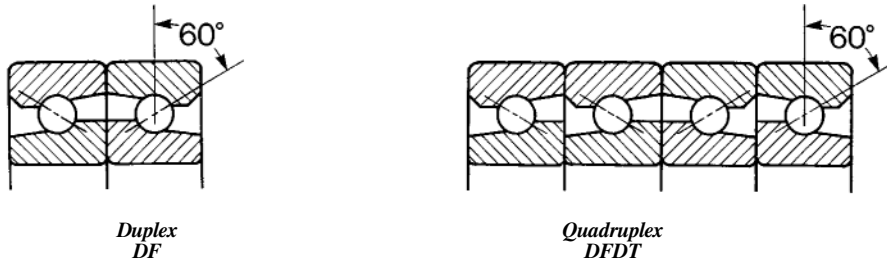

The MRC ball screw support bearing is a single-row angular contact nonseparable bearing with one heavy race shoulder and one counterbored race shoulder on the outer ring. The inner ring is similar in design having a counterbored race shoulder.

Construction and ring design permit a greater number of balls than the standard angular contact types, and result in a very high thrust load-carrying capacity. The 60° initial contact angle provides maximum axial rigidity. As heavy thrust must be taken in both directions, these angular contact bearings are mounted in duplex pairs. For even stiffer screw support, the bearings can be mounted in quadruple sets.

These bearings are made in ABEC-7 tolerance grade only. Inner and outer rings and balls are of AISI 52100 steel. Retainers are a ball-riding type of molded polyamide composition.

These ball screw support bearings are designed for use in numerically controlled machine tools where standard angular contact bearings or roller bearings cannot deliver the rigidity levels required. The 60° contact angle contributes to maximum axial rigidity and gives very stiff screw support to maintain the accuracy of the ball screw.

Cage Types and Materials

One-piece molded polyamide, ball-riding cages are supplied with ball screw support bearings.

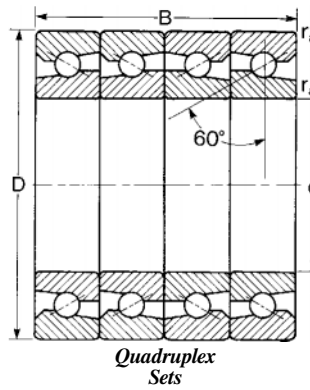
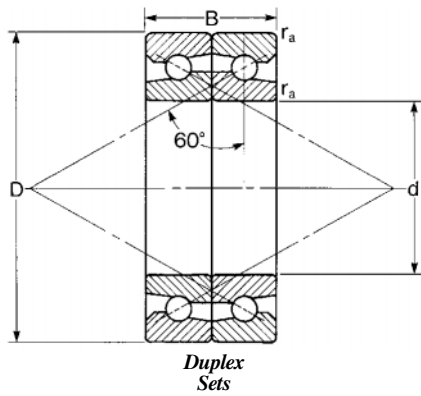

MRC Bearing Number	Bore		Outside Diameter D		Width B		Fillet Radius ¹⁾ r _a		Lateral Eccentricity Max		Basic Radial Load Rating ²⁾			
	d										Dynamic C ³⁾		Static C ₀	
	mm	in	mm	in	mm	in	mm	in	mm	in	N	lbf	N	lbf
J078DF	20.000	.7874	47.000	1.8504	31.750	1.2500	.80	.031	.003	.0001	12 100	2 720	10 000	2 250
J093DF	23.838	.9385	62.000	2.4409	31.750	1.2500	.80	.031	.003	.0001	13 800	3 100	13 700	3 080
J098DF	25.000	.9843	62.000	2.4409	31.750	1.2500	.80	.031	.003	.0001	13 800	3 100	13 700	3 080
J150DF	38.100	1.5000	72.000	2.8346	31.750	1.2500	.80	.031	.003	.0001	14 600	3 280	15 300	3 440
J175DF	44.475	1.7510	76.200	3.0000	31.750	1.2500	.80	.031	.003	.0001	15 100	3 390	16 600	3 730
J225DF	57.150	2.2500	90.000	3.5433	31.750	1.2500	.80	.031	.003	.0001	16 300	3 660	20 000	4 500
J300DF	76.200	3.0000	110.000	4.3307	31.750	1.2500	.80	.031	.003	.0001	17 800	4 000	25 500	5 730
J400DF	101.600	4.0000	145.000	5.7087	44.450	1.7500	1.0	.040	.003	.0001	36 400	8 180	52 000	11 700
Quadruplex Sets														
J078DFDT	20.000	.7874	47.000	1.8504	63.500	2.5000	.80	.031	.003	.0001	19 500	4 380	20 000	4 500
J093DFDT	23.838	.9385	62.000	2.4409	63.500	2.5000	.80	.031	.003	.0001	22 500	5 060	26 500	5 960
J098DFDT	25.000	.9843	62.000	2.4409	63.500	2.5000	.80	.031	.003	.0001	22 500	5 060	26 500	5 960
J150DFDT	38.100	1.5000	72.000	2.8346	63.500	2.5000	.80	.031	.003	.0001	23 800	5 350	30 500	6 860
J175DFDT	44.475	1.7510	76.200	3.0000	63.500	2.5000	.80	.031	.003	.0001	24 700	5 550	33 500	7 530
J225DFDT	57.150	2.2500	90.000	3.5433	63.500	2.5000	.80	.031	.003	.0001	26 500	5 960	40 000	8 990
J300DFDT	76.200	3.0000	110.000	4.3307	63.500	2.5000	.80	.031	.003	.0001	29 100	6 540	51 000	11 500
J400DFDT	101.600	4.0000	145.000	5.7087	88.900	3.5000	1.0	.040	.003	.0001	59 200	13 300	104 000	23 400

¹⁾ Fillet radius indicates maximum fillet radius on shaft or in housing which bearing corner will clear.

²⁾ For thrust rating multiply C by 1.70 and C₀ by 4.00.

³⁾ Rating for one million revolutions or 500 hours at 33 1/3 RPM.

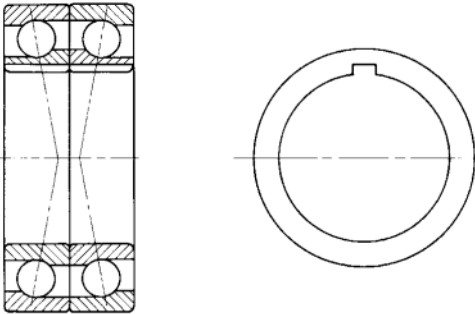

Each MRC bearing made for Ex-Cell-O[®], spindles is a separable inner ring type with counterbored outer ring, with the cage and ball assembly remaining together as a unit. The bearings are manufactured to a basic ABEC-7 grade with a minus tolerance on the nominal bore and O.D. The cage, which is outer ring land-guided, has a chamfer on the bore to provide for improved flow of lubricant.

These bearings are packed in pairs, with one bearing of the pair marked with a single burnished dot on both inner and outer ring faces. The other bearing is marked with two burnished dots on both the inner and outer rings. These dots help avoid mixing of the separable bearing parts and also indicate high points of eccentricity on inner and outer rings.

Identification Markings

Ball bearings furnished for replacement use are identical to those provided for Ex-Cell-O OEM use except for identification markings. The small table below shows typical markings on inner and outer rings of MRC replacement bearings and Ex-Cell-O bearings.

	MRC Replacement Bearings	Ex-Cell-O OEM Bearings
Inner Ring	MRC USA D	MRC USA D
Outer Ring	XO-30-RBDS-16	XLO-30-57

Note that both the OEM and replacement bearings have the same marking on the inner ring—MRC USA D. However, on the outer ring of the OEM bearings, a typical marking shows XLO-30-57: XLO is the Ex-Cell-O trademark, 30 indicates the basic bearing size, 57 denotes preload group 5 (not preload in pounds) and tolerance grade ABEC-7. MRC replacement bearings are marked XO-30-RBDS-16 on the outer ring: XO designates Ex-Cell-O bearings, 30 shows the basic bearing number, RBDS indicates duplex bearings with a preload of 16 pounds.

Shaft and House Fitting Practices

Basic dimensions of this new Ex-Cell-O bearing series remain the same as bearings previously furnished. The only external dimensional differences are in the bore and O.D. tolerances, and these must be considered when replacing the old series bearings. Current fitting practices in Ex-Cell-O spindles are 0.0001" tight to 0.0001" loose on the shaft, 0.0003" loose to 0.0005" loose in the floating end of the housing and 0.0001" loose to 0.0003" loose in the held end of the housing. Therefore, it may be necessary to alter shaft and housing seat diameters to retain correct fitting practices.

How To Order

The dimension table on the next two pages provides all MRC replacement bearing numbers and corresponding Ex-Cell-O part numbers. When ordering, specify MRC bearing number, operating speed or preload, or both to assure delivery of proper bearing for application.

Difference Between Old and New Types

Basic external dimensions are the same with only a change in tolerance of the bore and O.D. in the new type. The new ball cage provides a chamfer on the bore for better flow of lubricant. One shoulder of the inner ring is low enough to permit separation from the outer ring, ball and cage assembly.

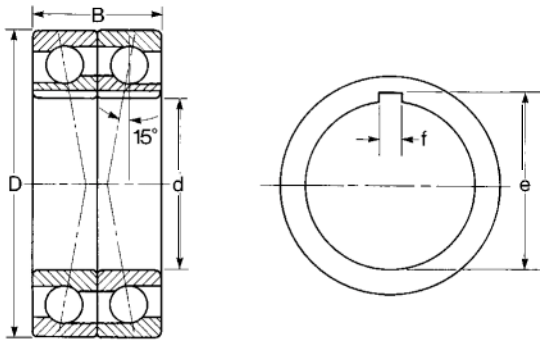

MRC Replacement Bearing Number	X-L-O Part Number	Bore		Outside Diameter D		Width B		Keyway			
		d mm	in	mm	in	mm	in	e mm	in	f mm	in
XO-20-RBDS	20-27 20-107	9.53	.37500	28.58	1.1250	17.46	.6875	9.9	.3906	1.6	.0625
XO-30-RBDS	30-17 30-27 30-57 30-77 30-107	15.88	.62500	38.10	1.5000	25.4	1.000	16.4	.645	1.6	.0625
XO-55-RBDS	55-17 55-27 55-57 55-87 55-107	20.64	.81250	50.80	2.0000	25.4	1.000	21.4	.844	1.6	.063
XO-57-RBDS	57-17 57-27 57-57 57-87 57-107	26.99	1.06250	57.15	2.2500	25.4	1.000	27.5	1.082	1.6	.063
XO-67-RBDS	67-17 67-37 67-57 67-87 67-107	31.75	1.2500	61.91	2.4375	31.75	1.250	32.6	1.285	3.2	.125
XO-90-RBDS	90-17 90-47 90-57 90-67 90-77 90-107	41.28	1.6250	87.31	3.4375	41.28	1.625	42.2	1.660	3.2	.125
XO-115-RBDS	115-17 115-27 115-37 115-47 115-57 115-77	57.15	2.2500	120.7	4.7500	57.15	2.250	58.4	2.300	4.7	.187
XO-135-RBDS	135-27 135-47 135-67 135-77 135-107	31.75	1.2500	68.26	2.6875	31.75	1.250	32.6	1.285	3.2	.125
XO-155-RBDS	155-07 155-17 155-37 155-47 155-67 155-87 155-107	69.85	2.7500	120.7	4.7500	57.15	2.250	70.9	2.790	4.7	.187
XO-165-RBDS	165-17 165-27 165-47 165-57 165-67 165-87	88.903	3.50000	160.3	6.3125	76.2	3.000	89.5	3.525	6.4	.250

MRC Replacement Bearing Number	Fillet Radius ¹⁾		Pre-Load Lbs.	Maximum Speed (RPM)		
	r_a mm	in		Grease Lub.	Oil Lub.	Mist Lub.
XO-20-RBDS	.6	.025	10	35 000	45 000	60 000
			0	40 000	65 000	80 000
XO-30-RBDS	1.0	.040	40	6 000	9 000	12 000
			30	10 000	12 500	18 000
			16	27 000	30 000	35 000
			10	30 000	35 000	45 000
			0	35 000	40 000	60 000
XO-55-RBDS	1.0	.040	80	2 000	4 000	6 000
			50	5 000	8 000	12 000
			30	20 000	22 000	24 000
			10	22 000	24 000	32 000
			0	24 000	27 000	45 000
XO-57-RBDS	1.0	.040	90	2 000	4 000	6 000
			50	5 000	8 000	12 000
			15	20 000	22 000	24 000
			10	22 000	24 000	32 000
			0	24 000	27 000	45 000
XO-67-RBDS	1.0	.040	92	3 600	4 500	6 000
			60	6 000	8 000	12 000
			20	12 500	15 000	22 000
			10	14 000	18 000	28 000
			0	16 000	20 000	35 000
XO-90-RBDS	1.5	.060	325	1 000	2 000	4 000
			180	3 000	5 000	8 000
			120	5 000	7 000	11 000
			72	8 000	10 000	14 000
			40	10 000	14 000	20 000
			0	12 000	16 000	22 000
XO-115-RBDS	2.0	.080	450	750	1 500	2 250
			350	1 000	2 000	3 000
			200	2 200	3 500	6 000
			150	3 000	4 500	7 000
			100	4 000	5 000	8 000
			30	6 000	8 000	15 000
XO-135-RBDS	1.0	.040	175	1 000	2 000	4 000
			90	3 600	4 500	6 000
			60	6 000	7 500	12 000
			25	10 000	12 000	18 000
			0	15 000	19 000	28 000
XO-155-RBDS	2.0	.080	1 000	250	250	250
			450	500	1 000	1 500
			325	1 000	2 000	3 000
			250	2 500	3 500	5 000
			150	4 000	5 000	6 500
			60	6 000	7 000	10 000
			0	7 000	9 000	12 000
XO-165-RBDS	2.0	.080	1200	500	800	1 200
			800	500	1 000	2 000
			400	1 000	2 000	4 000
			250	2 000	3 000	5 000
			175	3 000	4 000	6 000
			50	5 000	6 500	9 000

¹⁾ Fillet radius indicates maximum fillet radius on shaft or in housing which bearing corner will clear.

NOTES

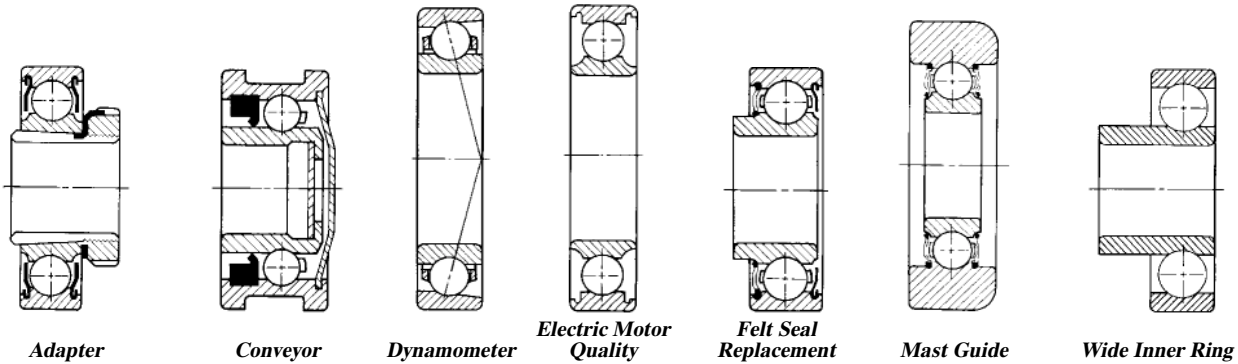

In addition to our standard line of bearing products, MRC Bearing Services also has the capability of supplying several non standard or specialty bearings. The bearings shown above and described on the following pages are a few examples of our specialty bearings. If you need information about a bearing type not shown please contact our engineering dept.

The following are brief descriptions of our specialty bearings.

Adapter

Adapter bearings have a tapered bore and are used with an adapter sleeve and locknut assembly on inch-size commercial shafting.

Conveyor

Conveyor bearings may be mounted directly into a conveyor roll or designed with O.D. slots for bracket mounting. They are equipped with closures for protection and lubricant retention.

Dynamometer

Dynamometer bearings are designed to minimize temperature, noise and vibration. Included are special tolerances and an inner ring land guided phenolic composition cage.

Electric Motor Quality

Electric motor quality bearings are designed to provide quiet and smooth operation in electric motors. They are available in various configurations including open and single or double sealed or shielded types.

Felt Seal Replacement

Felt seal replacement bearings incorporate synthetic rubber seals and are a direct replacement for the felt seal type.

Mast Guide

Mast guide bearings consist of a family of special bearings designed to meet the rigorous demands of industrial truck service. For protection they are equipped with synthetic rubber or polypropylene seals.

Wide Inner Ring

Wide inner ring bearings are used in electric motors. The wide inner ring permits the bearing to be mounted without using a locknut on the shaft.

Type	Page
Adapter	202
Conveyor Roll	203
Dynamometer	205
Electric Motor Quality	209
Felt Seal Replacement	224
Mast Guide	229
Wide Inner Ring	233

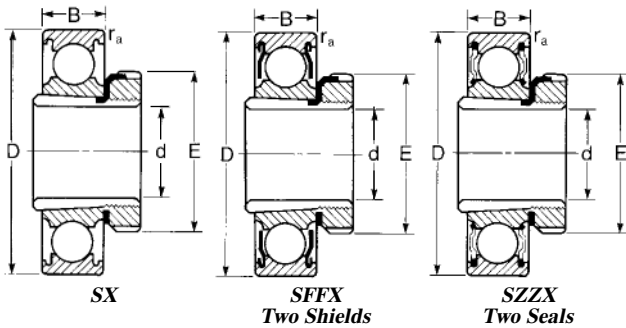

Adapter-type bearings, when used with adapter sleeves, are designed for mounting on inch size shafting without machining the shaft. The tapered sleeve is drawn into the tapered bore of the bearing as the nut is tightened. Soft steel sleeve adapts to the shaft and grips it tightly. Tapered bore of bearing is 1" to 1' (included angle 4° 46' 19"). Adapter sleeve designation includes nut and lockwasher.

Note: Adapter and nut are not furnished with bearings.

Shaft Diameter d In Inches	MRC Bearing Number	Outside Diameter D mm in		Width B mm in		Fillet Radius ¹⁾ r _a mm in		Adapter Sleeve	Basic Radial Load Rating				Speed Rating ²⁾					
									ZD ²⁾		Dynamic C _d ³⁾		Static C ₀		Open and Shielded Grease	Shielded Oil	Single and Double Sealed Grease	
									mm	in	N	lbf	N	lbf	RPM	RPM	RPM	
1 ⁵ / ₁₆	1	206-SFFX	62	2.4409	16	.6299	1.0	.04	SNW6	819	1.27	19 500	4 380	10 000	2 250	10 000	13 000	—
1 ⁵ / ₁₆	1	206-SZZX	62	2.4409	16	.6299	1.0	.04	SNW6	819	1.27	19 500	4 380	10 000	2 250	—	—	7 500
1 ¹ / ₈	1 ³ / ₁₆	207-SFFX	72	2.8346	17	.6693	1.0	.04	SNW7	1 140	1.76	27 000	6 070	15 300	3 440	9 000	11 000	—
1 ¹ / ₈	1 ³ / ₁₆	207-SZZX	72	2.8346	17	.6693	1.0	.04	SNW7	1 140	1.76	27 000	6 070	15 300	3 440	—	—	6 300
	1 ⁷ / ₁₆	209-SZZX	85	3.3465	19	.7480	1.0	.04	SNW9	1 640	2.54	36 400	8 180	22 800	5 130	—	—	5 000
	1 ³ / ₄	210-SX	90	3.5433	20	.7874	1.0	.04	SNW10	1 610	2.50	35 100	7 890	23 200	5 210	7 000	8 500	4 800
1 ¹⁵ / ₁₆		211-SX	100	3.9370	21	.8268	1.5	.06	SNW11	2 040	3.16	43 600	9 800	30 000	6 740	6 300	7 500	4 300
2 ¹ / ₁₆		212-SZZX	110	4.3307	22	.8661	1.5	.06	SNW12	2 520	3.91	47 500	10 700	32 500	7 310	—	—	4 000
2 ⁷ / ₁₆		215-SZZX	130	5.1181	25	.9843	1.5	.06	SNW15	3 350	5.20	66 300	14 900	49 000	11 000	—	—	3 200
3		217-SZZX	150	5.9055	28	1.1024	2.0	.08	SNW17	4 260	6.60	83 200	18 700	64 000	14 400	—	—	2 800

¹⁾ Fillet radius indicates maximum fillet radius on shaft or in housing which bearing corner will clear.

²⁾ Listed values are for pressed steel or polyamide cage, ABEC-1.

The values have been determined through historical application and practice. For a more complete explanation, see page 276.

³⁾ Rating for one million revolutions or 500 hours at 33¹/₃ RPM.

Conveyor roll ball bearings are offered for use in either inboard or outboard roll applications. Some types are designed for mounting directly into a roll, others are designed with a milled slot in the outer ring for simplified bracket mounting. Seals in the permanently lubricated bearing types retain lubricant for the life of the bearing, and protect against entrance of foreign matter. Maximum adjustment for belt alignment is provided, resulting in less belt wear. Cadmium-plated outer rings are supplied, except in CONV-3-Y-2 and CONV-4SZZ-2.

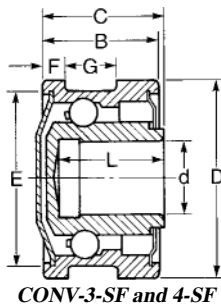

CONV-3-SF and 4-SF

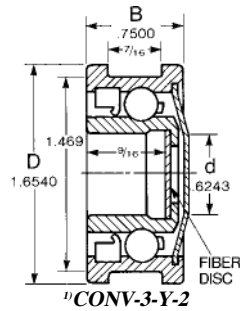

¹⁾ CONV-3-Y-2

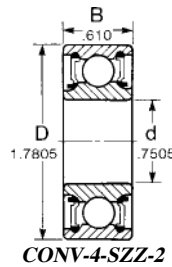

CONV-4-SZZ-2

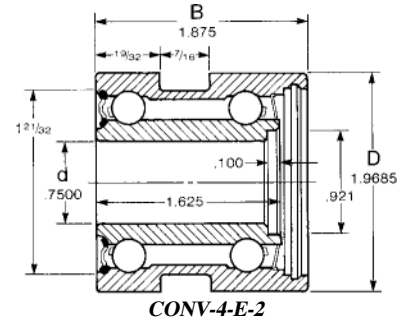

CONV-4-E-2

MRC Bearing Number	Dimensions in Inches								Approx. Weight lb.	Basic Radial Load Rating			
										Dynamic C ²⁾		Static C ₀	
	d	D	B	C	L	E	F	G		N	lbf	N	lbf
CONV-3-SF	.6243	1.6540	.9688	1.000	7/16	1.469	3/16	7/16	.37	5 920	1 330	4 000	899
CONV-4-SF	.7874	1.9685	1.0000	1.0625	29/32	1.781	9/32	7/16	.55	13 500	3 030	11 400	2 560
CONV-4-SZZ2	.7505	1.7805	.610	—	—	—	—	—	.22	13 500	3 030	11 400	2 560
CONV-3-Y-2	All dimensions shown in drawings above								.27	5 920	1 330	4 000	899
CONV-4-E-2	All dimensions shown in drawings above								.91	13 500	3 030	11 400	2 560

¹⁾ CONV-3-Y-4 also available. Same as CONV-3-Y-2 except cadmium-plated outer ring and shield. May be substituted for CONV-3-Y-2.

²⁾ Rating for one million revolutions or 500 hours at 33 1/3 RPM.

Conveyor rolls equipped with CONV-504-3 bearings turn on stub shafts designed for self-alignment in bearing bore and ease of removal. CONV-504-3 is fitted with synthetic rubber seals which effectively seal out contaminants. Check availability of stub shafts.

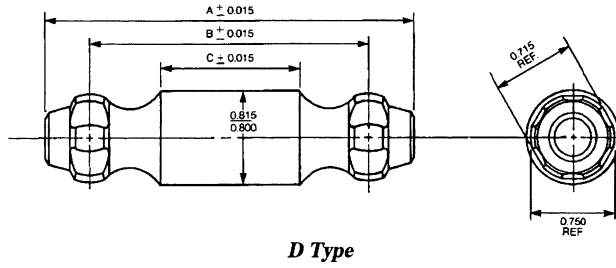
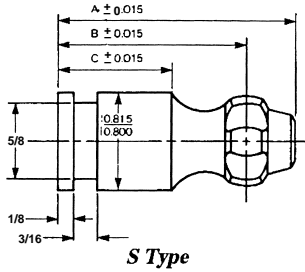
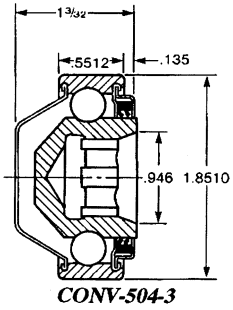

Stub Shaft Diameter	Dimensions in Inches		
	A	B	C
S1938	1.938	1.547	.938
S2500	2.500	2.109	1.500
S3000	3.000	2.609	2.000
S4125	4.125	3.734	3.125
D2500	2.500	1.719	.500
D2625	2.625	1.844	.625
D3000	3.000	2.219	1.000

MRC Bearing Number	Basic Radial Load Rating			
	Dynamic C ₁ ¹⁾		Static C ₀	
	N	LB	N	LB
CONV504-3	8 850	1 990	5 650	1 270

¹⁾ Rating for one million revolutions or 500 hours at 33 1/3 RPM.

For several years, MRC Bearing Services has supplied specially designed bearings for dynamometer applications. These bearings are manufactured with the following characteristics.

- ABEC 5 Inner Ring Tolerances.
- Inner ring eccentricity value, not to exceed 0.0005", marked on the inner ring face at the location of maximum lateral runout.
- Special internal radial clearance.
- Special "E" Grade Balls.
- High speed, lightweight, inner ring land-guided phenolic (Bakelite) separators.

Dynamometer Bearing Identification

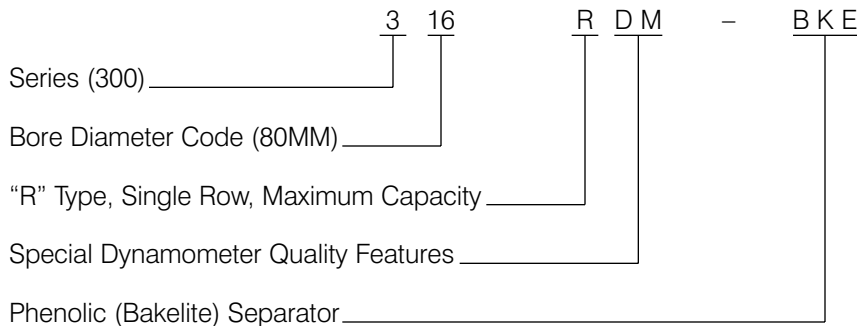

These bearings were developed to minimize operating temperatures, noise and vibration in dynamometer applications. To achieve best results the value of eccentricity marked on the inner ring face should be aligned 180° opposite the high point of eccentricity measured at the shaft journal. If the bearings are grease lubricated, they should be carefully hand packed prior to installation to make sure that grease is worked into the close running clearance between the O.D. of the inner ring and the I.D. of the separator.

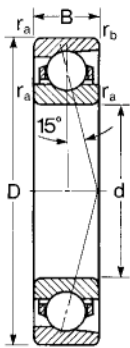

200-RDM Series dynamometer bearings are made with bore diameters ranging from 80mm to 130mm. These bearings are recommended for high speed dynamometers or any application involving moderate to heavy radial loads, moderate thrust loads in one direction, or for combinations of both.

MRC Bearing Number	Bore		Outside Diameter D		Width B		Fillet Radius ¹⁾				ZD ²⁾		Basic Radial Load Rating		Speed Rating ²⁾			
													Dynamic C _r ³⁾		Static C ₀		Grease	Oil
	d	mm	in	mm	in	mm	in	r _a	mm	in	r _b	mm	in	N	lbf	N	lbf	RPM
216RDM	80	3.1496	140	5.5118	26	1.0236	2.0	.08	1.0	.040	4 880	7.57	85 200	19 200	73 500	16 500	10 300	14 800
218RDM	90	3.5433	160	6.2992	30	1.1811	2.0	.08	1.0	.040	7 870	12.2	130 000	29 200	116 000	26 100	8 700	12 600
219RDM	95	3.7402	170	6.6929	32	1.2598	2.0	.08	1.0	.040	8 390	13.0	138 000	31 000	125 000	28 100	8 300	12 000
220RDM	100	3.9370	180	7.0866	34	1.3386	2.0	.08	1.0	.040	9 610	14.9	153 000	34 400	143 000	32 100	7 800	11 200
221RDM	105	4.1339	190	7.4803	36	1.4173	2.0	.08	1.0	.040	10 300	16.0	168 000	37 800	153 000	34 400	7 400	10 600
226RDM	130	5.1181	230	9.0551	40	1.5748	2.5	.10	1.0	.040	15 500	24.0	221 000	49 700	232 000	52 200	6 000	9 000

¹⁾ Fillet radius indicates maximum fillet radius on shaft or in housing which bearing corner will clear.

²⁾ Listed values are for inner ring land guided, phenolic composition cage.

The values have been determined through historical application and practice. For a more complete explanation, see page 276.

³⁾ Rating for one million revolutions or 500 hours at 33 1/3 RPM.

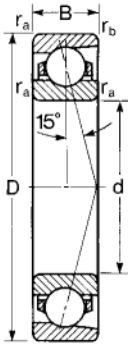

300-RDM Series dynamometer bearings are made with bore diameters ranging from 35mm to 160mm. These bearings are recommended for high speed dynamometers or any application involving moderate to heavy radial loads, moderate thrust loads in one direction, or for combinations of both.

MRC Bearing Number	Bore		Outside Diameter D		Width B		Fillet Radius ¹⁾				Basic Radial Load Rating				Speed Rating ²⁾			
											Dynamic C ³⁾		Static C ₀		Grease	Oil		
	mm	in	mm	in	mm	in	mm	in	mm	in	mm	in	N	lbf	N	lbf	RPM	RPM
307RDM	35	1.3780	80	3.1496	21	.8268	1.5	.06	1.0	.040	1 940	3.00	39 000	8 770	26 000	5 850	19 500	28 000
309RDM	45	1.7717	100	3.9370	25	.9843	1.5	.06	1.0	.040	3 030	4.69	58 500	13 200	40 500	9 100	15 400	22 400
310RDM	50	1.9685	110	4.3307	27	1.0630	2.0	.08	1.0	.040	4 350	6.75	80 600	18 100	57 000	12 800	14 500	21 000
311RDM	55	2.1654	120	4.7244	29	1.1417	2.0	.08	1.0	.040	5 110	7.92	93 600	21 000	67 000	15 100	12 900	18 700
312RDM	60	2.3622	130	5.1181	31	1.2205	2.0	.08	1.0	.040	5 930	9.19	108 000	24 300	78 000	17 500	11 500	16 800
313RDM	65	2.5591	140	5.5118	33	1.2992	2.0	.08	1.0	.040	6 900	10.7	121 000	27 200	93 000	20 900	11 000	15 700
315RDM	75	2.9528	160	6.2992	37	1.4567	2.0	.08	1.0	.040	9 050	14.0	153 000	34 400	122 000	27 400	9 900	14 000
316RDM	80	3.1496	170	6.6929	39	1.5354	2.0	.08	1.0	.040	9 480	14.7	159 000	35 700	129 000	29 000	8 700	12 600
318RDM	90	3.5433	190	7.4803	43	1.6929	2.5	.10	1.0	.040	11 800	18.3	185 000	41 600	160 000	36 000	7 800	11 200
320RDM	100	3.9370	215	8.4646	47	1.8504	2.5	.10	1.0	.040	14 400	22.4	212 000	47 700	200 000	45 000	6 900	10 100
321RDM	105	4.1339	225	8.8583	49	1.9291	2.5	.10	1.0	.040	15 900	24.6	229 000	51 500	204 000	45 900	6 400	9 500
322RDM	110	4.3307	240	9.4488	50	1.9685	2.5	.10	1.0	.040	18 800	29.2	255 000	57 300	255 000	57 300	6 000	9 000
324RDM	120	4.7244	260	10.2352	55	2.1654	2.5	.10	1.0	.040	22 100	34.3	265 000	59 600	300 000	67 400	6 000	8 400
326RDM	130	5.1181	280	11.0236	58	2.2835	3.0	.12	1.0	.040	25 700	39.8	296 000	66 500	345 000	77 600	5 300	7 800
328RDM	140	5.5118	300	11.8110	62	2.4409	3.0	.12	1.0	.040	29 500	45.7	351 000	78 900	400 000	89 900	4 800	7 300
330RDM	150	5.9055	320	12.5984	65	2.5591	3.0	.12	1.0	.040	33 900	52.6	390 000	87 700	475 000	107 000	4 600	6 700
332RDM	160	6.2992	340	13.3853	68	2.6772	3.0	.12	1.0	.040	38 400	59.6	423 000	95 100	530 000	119 000	4 100	6 200

¹⁾ Fillet radius indicates maximum fillet radius on shaft or in housing which bearing corner will clear.

²⁾ Listed values are for inner ring land guided, phenolic composition cage.

The values have been determined through historical application and practice. For a more complete explanation, see page 276.

³⁾ Rating for one million revolutions or 500 hours at 33½ RPM.

NOTES

To meet the demand for high quality, energy efficient, quiet and smooth running electric motors, MRC Bearing Services has available a line of bearings specifically aimed at the electric motor market. MRC bearing containers are clearly marked with the letters EMQ to identify them as being Electric Motor Quality.

These specialty bearings are single row, deep groove, conrad style with the capability to handle both thrust and radial loads. They can be supplied in a variety of different configurations including open, single closure seal or shield and double closure seals or shields.

Prelubricated bearings are normally packed with premium quality Chevron SRI #2 grease. Other types of grease are available upon request.

Many electric motor specification plates identify the bearings to be used in the motor with an ABMA number. For your convenience, a list of popular electric motor bearings and their corresponding ABMA numbers are included in the following tables.

For an explanation of ABMA identification codes refer to page 347.

Bearing Data	Page
Bearing Size—ABMA Number	210
Shaft and Housing Fits	222

ABMA Numbers and MRC Equivalent

MRC Bearing Services

ABMA Number	Bearing Size
8BIC00X30	R8
8BIC10XD30	R8Z
8BIC10XDD30	R8ZZ
8BIC10XP30	R8F
8BIC10XPP30	R8FF
10BIC10X30	R10
10BIC10XD30	R10Z
10BIC10XDD30	R10ZZ
10BIC10XP30	R10F
10BIC10XPP30	R10FF
12BIC10X30	R12
12BIC10XD30	R12Z
12BIC10XDD30	R12ZZ
12BIC10XP30	R12F
12BIC10XPP30	R12FF
14BIC10X30	R14
14BIC10XD30	R14Z
14BIC10XDD30	R14ZZ
14BIC10XP30	R14F
14BIC10XPP30	R14FF
15BC02X30	202S
15BC02XD30	202SZ
15BC02XDD30	202SZZ
15BC02XDDG30	202SZZG
15BC02XDYG30	202SZG
15BC02XP30	202SF
15BC02XPP30	202SFF
15BC02XPPG30	202SFFG
15BC02XPYG30	202SFG
15BC02XXYG30	202SG
15BC03X30	302S
15BC03XD30	302SZ
15BC03XDD30	302SZZ
15BC03XDDG30	302SZZG
15BC03XDYG30	302SZG
15BC03XP30	302SF
15BC03XPP30	302SFF
15BC03XPPG30	302SFFG
15BC03XPYG30	302SFG
15BC03XXYG30	302SG
15BC10X30	102KS
15BC10XD30	102KSZ

ABMA Number	Bearing Size
15BC10XDD30	102KSZZ
15BC10XDDG30	102KSZZG
15BC10XDYG30	102KSZG
15BC10XPP30	102KSFF
15BC10XP30	102KSF
15BC10XPPG30	102KSFFG
15BC10XPYG30	102KSFG
15BC10XXYG30	102KSG
15BC19X30	1902S
15BC19XD30	1902SZ
15BC19XDD30	1902SZZ
15BC19XP30	1902SF
15BC19XPP30	1902SFF
15BC32XDD30	202SZZC
15BC32XDDG30	202SZZCG
15BC32XPP30	202SFFC
15BC32XPPG30	202SFFCG
15BC33XDD30	302SZZC
15BC33XDDG30	302SZZCG
15BC33XPP30	302SFFC
15BC33XPPG30	302SFFCG
16BIC10X30	R16
16BIC10XD30	R16Z
16BIC10XDD30	R16ZZ
16BIC10XP30	R16F
16BIC10XPP30	R16FF
17BC02X30	203S
17BC02XD30	203SZ
17BC02XDD30	203SZZ
17BC02XDDG30	203SZZG
17BC02XDYG30	203SZG
17BC02XP30	203SF
17BC02XPP30	203SFF
17BC02XPYG30	203SFG
17BC02XPPG30	203SFFG
17BC02XXYG30	203SG
17BC03X30	303S
17BC03XD30	303SZ
17BC03XDD30	303SZZ
17BC03XDDG30	303SZZG
17BC03XDYG30	303SZG
17BC03XP30	303SF

ABMA Number	Bearing Size
17BC03XPP30	303SFF
17BC03XPPG30	303SFFG
17BC03XPXG30	303SFG
17BC03XXG30	303SG
17BC04X30	403S
17BC04XD30	403SZ
17BC04XDD30	403SZZ
17BC04XP30	403SF
17BC04XPP30	403SFF
17BC10X30	103KS
17BC10XD30	103KSZ
17BC10XDD30	103KSZZ
17BC10XDDG30	103KSZZG
17BC10DXG30	103KSZG
17BC10XP30	103KSF
17BC10XPP30	103KSFF
17BC10XPPG30	103KSFFG
17BC10XPXG30	103KSFG
17BC10XXG30	103KSG
17BC19X30	1903S
17BC19XD30	1903SZ
17BC19XDD30	1903SZZ
17BC19XP30	1903SF
17BC19XPP30	1903SFF
17BC32XDD30	203SZZC
17BC32XDDG30	203SZZCG
17BC32XPP30	203SFFC
17BC32XPPG30	203SFFCG
17BC33XDD30	303SZZC
17BC33XDDG30	303SZZCG
17BC33XPP30	303SFFC
17BC33XPPG30	303SFFCG
18BIC10X30	R18
18BIC10XD30	R18Z
18BIC10XDD30	R18ZZ
18BIC10XP30	R18F
18BIC10XPP30	R18FF
20BC02X30	204S
20BC02XD30	204SZ
20BC02XDD30	204SZZ
20BC02XDDG30	204SZZG
20BC02DXG30	204SZG

ABMA Number	Bearing Size
20BC02XP30	204SF
20BC02XPP30	204SFF
20BC02XPPG30	204SFFG
20BC02XPXG30	204SFG
20BC02XXG30	204SG
20BC03X30	304S
20BC03XD30	304SZ
20BC03XDD30	304SZZ
20BC03XDDG30	304SZZG
20BC03DXG30	304SZG
20BC03XP30	304SF
20BC03XPP30	304SFF
20BC03XPPG30	304SFFG
20BC03XPXG30	304SFG
20BC03XXG30	304SG
20BC04X30	404S
20BC04XD30	404SZ
20BC04XDD30	404SZZ
20BC04XP30	404SF
20BC04XPP30	404SFF
20BC10X30	104KS
20BC10XD30	104KSZ
20BC10XDD30	104KSZZ
20BC10XDDG30	104KSZZG
20BC10DXG30	104KSZG
20BC10XP30	104KSF
20BC10XPP30	104KSFF
20BC10XPPG30	104KSFFG
20BC10XPXG30	104KSFG
20BC10XXG30	104KSG
20BC19X30	1904S
20BC19XD30	1904SZ
20BC19XDD30	1904SZZ
20BC19XP30	1904SF
20BC19XPP30	1904SFF
20BC32XDD30	204SZZC
20BC32XDDG30	204SZZCG
20BC32XPP30	204SFFC
20BC32XPPG30	204SFFCG
20BC33XDD30	304SZZC
20BC33XDDG30	304SZZCG
20BC33XPP30	304SFFC

ABMA Numbers and MRC Equivalent

MRC Bearing Services

ABMA Number	Bearing Size
20BC33XPPG30	304SFFCG
20BIC10X30	R20
20BIC10XD30	R20Z
20BIC10XDD30	R20ZZ
20BIC10XP30	R20F
20BIC10XPP30	R20FF
24BIC10X30	R24
24BIC10XD30	R24Z
24BIC10XDD30	R24ZZ
24BIC10XP30	R24F
24BIC10XPP30	R24FF
25BC02X30	205S
25BC02XD30	205SZ
25BC02XDD30	205SZZ
25BC02XDDG30	205SZZG
25BC02XDYG30	205SZG
25BC02XP30	205SF
25BC02XPP30	205SFF
25BC02XPPG30	205SFFG
25BC02XPYG30	205SFG
25BC02XXYG30	205SG
25BC03X30	305S
25BC03XD30	305SZ
25BC03XDD30	305SZZ
25BC03XDDG30	305SZZG
25BC03XDYG30	305SZG
25BC03XP30	305SF
25BC03XPP30	305SFF
25BC03XPPG30	305SFFG
25BC03XPYG30	305SFG
25BC03XXYG30	305SG
25BC04X30	405S
25BC04XD30	405SZ
25BC04XDD30	405SZZ
25BC04XP30	405SF
25BC04XPP30	405SFF
25BC10X30	105KS
25BC10XD30	105KSZ
25BC10XDD30	105KSZZ
25BC10XDDG30	105KSZZG
25BC10XDYG30	105KSZG
25BC10XP30	105KSF

ABMA Number	Bearing Size
25BC10XPP30	105KSFF
25BC10XPPG30	105KSFFG
25BC10XPYG30	105KSFG
25BC10XXYG30	105KSG
25BC19X30	1905S
25BC19XD30	1905SZ
25BC19XDD30	1905SZZ
25BC19XP30	1905SF
25BC19XPP30	1905SFF
25BC32XDD30	205SZZC
25BC32XDDG30	205SZZCG
25BC32XPP30	205SFFC
25BC32XPPG30	205SFFCG
25BC33XDD30	305SZZC
25BC33XDDG30	305SZZCG
25BC33XPP30	305SFFC
25BC33XPPG30	305SFFCG
30BC02X30	206S
30BC02XD30	206SZ
30BC02XDD30	206SZZ
30BC02XDDG30	206SZZG
30BC02XDYG30	206SZG
30BC02XP30	206SF
30BC02XPP30	206SFF
30BC02XPPG30	206SFFG
30BC02XPYG30	206SFG
30BC02XXYG30	206SG
30BC03X30	306S
30BC03XD30	306SZ
30BC03XDD30	306SZZ
30BC03XDDG30	306SZZG
30BC03XDYG30	306SZG
30BC03XP30	306SF
30BC03XPP30	306SFF
30BC03XPPG30	306SFFG
30BC03XPYG30	306SFG
30BC03XXYG30	306SG
30BC04X30	406S
30BC04XD30	406SZ
30BC04XDD30	406SZZ
30BC04XP30	406SF
30BC04XPP30	406SFF

ABMA Number	Bearing Size
30BC10X30	106KS
30BC10XD30	106KSZ
30BC10XDD30	106KSZZ
30BC10XDDG30	106KSZZG
30BC10XDYG30	106KSZG
30BC10XP30	106KSF
30BC10XPP30	106KSFF
30BC10XPPG30	106KSFFG
30BC10XPYG30	106KSFG
30BC10XXG30	106KSG
30BC19X30	1906S
30BC19XD30	1906SZ
30BC19XDD30	1906SZZ
30BC19XP30	1906SF
30BC19XPP30	1906SFF
30BC32XDD30	206SZZC
30BC32XDDG30	206SZZCG
30BC32XPP30	206SFFC
30BC32XPPG30	206SFFCG
30BC33XDD30	306SZZC
30BC33XDDG30	306SZZCG
30BC33XPP30	306SFFC
30BC33XPPG30	306SFFCG
35BC02X30	207S
35BC02XD30	207SZ
35BC02XDD30	207SZZ
35BC02XDDG30	207SZZG
35BC02XDYG30	207SZG
35BC02XP30	207SF
35BC02XPP30	207SFF
35BC02XPPG30	207SFFG
35BC02XPYG30	207SFG
35BC02XXG30	207SG
35BC03X30	307S
35BC03XD30	307SZ
35BC03XDD30	307SZZ
35BC03XDDG30	307SZZG
35BC03XDYG30	307SZG
35BC03XP30	307SF
35BC03XPP30	307SFF
35BC03XPPG30	307SFFG
35BC03XPYG30	307SFG

ABMA Number	Bearing Size
35BC03XXYG30	307SG
35BC04X30	407S
35BC04XD30	407SZ
35BC04XDD30	407SZZ
35BC04XP30	407SF
35BC04XPP30	407SFF
35BC10X30	107KS
35BC10XD30	107KSZ
35BC10XDD30	107KSZZ
35BC10XDDG30	107KSZZG
35BC10XDYG30	107KSZG
35BC10XP30	107KSF
35BC10XPP30	107KSFF
35BC10XPPG30	107KSFFG
35BC10XPYG30	107KSFG
35BC10XXYG30	107KSG
35BC19X30	1907S
35BC19XD30	1907SZ
35BC19XDD30	1907SZZ
35BC19XP30	1907SF
35BC19XPP30	1907SFF
35BC32XDD30	207SZZC
35BC32XDDG30	207SZZCG
35BC32XPP30	207SFFC
35BC32XPPG30	207SFFCG
35BC33XDD30	307SZZC
35BC33XDDG30	307SZZCG
35BC33XPP30	307SFFC
35BC33XPPG30	307SFFCG
40BC02X30	208S
40BC02XD30	208SZ
40BC02XDD30	208SZZ
40BC02XDDG30	208SZZG
40BC02XDYG30	208SZG
40BC02XP30	208SF
40BC02XPP30	208SFF
40BC02XPPG30	208SFFG
40BC02XPYG30	208SFG
40BC02XXYG30	208SG
40BC03X30	308S
40BC03XD30	308SZ
40BC03XDD30	308SZZ

ABMA Numbers and MRC Equivalent

MRC Bearing Services

ABMA Number	Bearing Size
40BC03XDDG30	308SZZG
40BC03XDYG30	308SZG
40BC03XP30	308SF
40BC03XPP30	308SFF
40BC03XPPG30	308SFFG
40BC03XPYG30	308SFG
40BC03XXYG30	308SG
40BC04X30	408S
40BC04XD30	408SZ
40BC04XDD30	408SZZ
40BC04XP30	408SF
40BC04XPP30	408SFF
40BC10X30	108KS
40BC10XD30	108KSZ
40BC10XDD30	108KSZZ
40BC10XDDG30	108KSZZG
40BC10XDYG30	108KSZG
40BC10XP30	108KSF
40BC10XPP30	108KSFF
40BC10XPPG30	108KSFFG
40BC10XPYG30	108KSFG
40BC10XXYG30	108KSG
40BC19X30	1908S
40BC19XD30	1908SZ
40BC19XDD30	1908SZZ
40BC19XP30	1908SF
40BC19XPP30	1908SFF
40BC32XDD30	208SZZC
40BC32XDDG30	208SZZCG
40BC32XPP30	208SFFC
40BC32XPPG30	208SFFCG
40BC33XDD30	308SZZC
40BC33XDDG30	308SZZCG
40BC33XPP30	308SFFC
40BC33XPPG30	308SFFCG
45BC02X30	209S
45BC02XD30	209SZ
45BC02XDD30	209SZZ
45BC02XDDG30	209SZZG
45BC02XDYG30	209SZG
45BC02XP30	209SF
45BC02XPP30	209SFF

ABMA Number	Bearing Size
45BC02XPPG30	209SFFG
45BC02XPYG30	209SFG
45BC02XXYG30	209SG
45BC03X30	309S
45BC03XD30	309SZ
45BC03XDD30	309SZZ
45BC03XDDG30	309SZZG
45BC03XDYG30	309SZG
45BC03XP30	309SF
45BC03XPP30	309SFF
45BC03XPPG30	309SFFG
45BC03XPYG30	309SFG
45BC03XXYG30	309SG
45BC04X30	409S
45BC04XD30	409SZ
45BC04XDD30	409SZZ
45BC04XP30	409SF
45BC04XPP30	409SFF
45BC10X30	109KS
45BC10XD30	109KSZ
45BC10XDD30	109KSZZ
45BC10XDDG30	109KSZZG
45BC10XDYG30	109KSZG
45BC10XP30	109KSF
45BC10XPP30	109KSFF
45BC10XPPG30	109KSFFG
45BC10XPYG30	109KSFG
45BC10XXYG30	109KSG
45BC19X30	1909S
45BC19XD30	1909SZ
45BC19XDD30	1909SZZ
45BC19XP30	1909SF
45BC19XPP30	1909SFF
45BC32XDD30	209SZZC
45BC32XDDG30	209SZZCG
45BC32XPP30	209SFFC
45BC32XPPG30	209SFFCG
45BC33XDD30	309SZZC
45BC33XDDG30	309SZZCG
45BC33XPP30	309SFFC
45BC33XPPG30	309SFFCG
50BC02X30	210S

ABMA Number	Bearing Size
50BC02XD30	210SZ
50BC02XDD30	210SZZ
50BC02XDDG30	210SZZG
50BC02XD3G30	210SZG
50BC02XP30	210SF
50BC02XPP30	210SFF
50BC02XPPG30	210SFFG
50BC02XP3G30	210SFG
50BC02XXG30	210SG
50BC03X30	310S
50BC03XD30	310SZ
50BC03XDD30	310SZZ
50BC03XDDG30	310SZZG
50BC03XD3G30	310SZG
50BC03XP30	310SF
50BC03XPP30	310SFF
50BC03XPPG30	310SFFG
50BC03XP3G30	310SFG
50BC03XXG30	310SG
50BC04X30	410S
50BC04XD30	410SZ
50BC04XDD30	410SZZ
50BC04XP30	410SF
50BC04XPP30	410SFF
50BC10X30	110KS
50BC10XD30	110KSZ
50BC10XDD30	110KSZZ
50BC10XDDG30	110KSZZG
50BC10XD3G30	110KSZG
50BC10XP30	110KSF
50BC10XPP30	110KSFF
50BC10XPPG30	110KSFFG
50BC10XP3G30	110KSFG
50BC10XXG30	110KSG
50BC19X30	1910S
50BC19XD30	1910SZ
50BC19XDD30	1910SZZ
50BC19XP30	1910SF
50BC19XPP30	1910SFF
50BC32XDD30	210SZZC
50BC32XDDG30	210SZZCG
50BC32XPP30	210SFFC

ABMA Number	Bearing Size
50BC32XSPPG30	210SFFCG
50BC33XDD30	310SZZC
50BC33XDDG30	310SZZCG
50BC33XPP30	310SFFC
50BC33XPPG30	310SFFCG
55BC02X30	211S
55BC02XD30	211SZ
55BC02XDD30	211SZZ
55BC02XDDG30	211SZZG
55BC02XD3G30	211SZG
55BC02XP30	211SF
55BC02XPP30	211SFF
55BC02XPPG30	211SFFG
55BC02XP3G30	211SFG
55BC02XXG30	211SG
55BC03X30	311S
55BC03XD30	311SZ
55BC03XDD30	311SZZ
55BC03XDDG30	311SZZG
55BC03XD3G30	311SZG
55BC03PP30	311SFF
55BC03XP30	311SF
55BC03XPPG30	311SFFG
55BC03XP3G30	311SFG
55BC03XXG30	311SG
55BC04X30	411S
55BC04XD30	411SZ
55BC04XDD30	411SZZ
55BC04XP30	411SF
55BC04XPP30	411SFF
55BC10X30	111KS
55BC10XD30	111KSZ
55BC10XDD30	111KSZZ
55BC10XDDG30	111KSZZG
55BC10XD3G30	111KSZG
55BC10XP30	111KSF
55BC10XPP30	111KSFF
55BC10XPPG30	111KSFFG
55BC10XP3G30	111KSFG
55BC10XXG30	111KSG
55BC19X30	1911S
55BC19XD30	1911SZ

ABMA Numbers and MRC Equivalent

MRC Bearing Services

ABMA Number	Bearing Size
55BC19XDD30	1911SZZ
55BC19XP30	1911SF
55BC19XPP30	1911SFF
55BC32XDD30	211SZZC
55BC32XDDG30	211SZZCG
55BC32XPP30	211SFFC
55BC32XPPG30	211SFFCG
55BC33XDD30	311SZZC
55BC33XDDG30	311SZZCG
55BC33XPP30	311SFFC
55BC33XPPG30	311SFFCG
60BC02X30	212S
60BC02XD30	212SZ
60BC02XDD30	212SZZ
60BC02XDDG30	212SZZG
60BC02XD3G30	212SZG
60BC02XP30	212SF
60BC02XPP30	212SFF
60BC02XPPG30	212SFFG
60BC02XP3G30	212SFG
60BC02XXG30	212SG
60BC03X30	312S
60BC03XD30	312SZ
60BC03XDD30	312SZZ
60BC03XDDG30	312SZZG
60BC03XD3G30	312SZG
60BC03XP30	312SF
60BC03XPP30	312SFF
60BC03XPPG30	312SFFG
60BC03XP3G30	312SFG
60BC03XXG30	312SG
60BC04X30	412S
60BC04XD30	412SZ
60BC04XDD30	412SZZ
60BC04XP30	412SF
60BC04XPP30	412SFF
60BC10X30	112KS
60BC10XD30	112KSZ
60BC10XDD30	112KSZZ
60BC10XDDG30	112KSZZG
60BC10XD3G30	112KSZG
60BC10XP30	112KSF

ABMA Number	Bearing Size
60BC10XPP30	112KSFF
60BC10XPPG30	112KSFFG
60BC10XP3G30	112KSFG
60BC10XXG30	112KSG
60BC19X30	1912S
60BC19XD30	1912SZ
60BC19XDD30	1912SZZ
60BC19XP30	1912SF
60BC19XPP30	1912SFF
60BC32XDD30	212SZZC
60BC32XDDG30	212SZZCG
60BC32XPP30	212SFFC
60BC32XPPG30	212SFFCG
60BC33XDD30	312SZZC
60BC33XDDG30	312SZZCG
60BC33XPP30	312SFFC
60BC33XPPG30	312SFFCG
65BC02X30	213S
65BC02XD30	213SZ
65BC02XDD30	213SZZ
65BC02XDDG30	213SZZG
65BC02XD3G30	213SZG
65BC02XP30	213SF
65BC02XPP30	213SFF
65BC02XPPG30	213SFFG
65BC02XP3G30	213SFG
65BC02XXG30	213SG
65BC03X30	313S
65BC03XD30	313SZ
65BC03XDD30	313SZZ
65BC03XDDG30	313SZZG
65BC03XD3G30	313SZG
65BC03XP30	313SF
65BC03XPP30	313SFF
65BC03XPPG30	313SFFG
65BC03XP3G30	313SFG
65BC03XXG30	313SG
65BC04X30	413S
65BC04XD30	413SZ
65BC04XDD30	413SZZ
65BC04XP30	413SF
65BC04XPP30	413SFF

ABMA Number	Bearing Size
65BC10X30	113KS
65BC10XD30	113KSZ
65BC10XDD30	113KSZZ
65BC10XDDG30	113KSZZG
65BC10XDYG30	113KSZG
65BC10XP30	113KSF
65BC10XPP30	113KSFF
65BC10XPPG30	113KSFFG
65BC10XPYG30	113KSFG
65BC10XXG30	113KSG
65BC19X30	1913S
65BC19XD30	1913SZ
65BC19XDD30	1913SZZ
65BC19XP30	1913SF
65BC19XPP30	1913SFF
65BC32XDD30	213SZZC
65BC32XDDG30	213SZZCG
65BC32XPP30	213SFFC
65BC32XPPG30	213SFFCG
65BC33XDD30	313SZZC
65BC33XDDG30	313SZZCG
65BC33XPP30	313SFFC
65BC33XPPG30	313SFFCG
70BC02X30	214S
70BC02XD30	214SZ
70BC02XDD30	214SZZ
70BC02XDDG30	214SZZG
70BC02XDYG30	214SZG
70BC02XP30	214SF
70BC02XPP30	214SFF
70BC02XPPG30	214SFFG
70BC02XPYG30	214SFG
70BC02XXG30	214SG
70BC03X30	314S
70BC03XD30	314SZ
70BC03XDD30	314SZZ
70BC03XDDG30	314SZZG
70BC03XDYG30	314SZG
70BC03XP30	314SF
70BC03XPP30	314SFF
70BC03XPPG30	314SFFG
70BC03XPYG30	314SFG

ABMA Number	Bearing Size
70BC03XXYG30	314SG
70BC04X30	414S
70BC04XD30	414SZ
70BC04XDD30	414SZZ
70BC04XP30	414SF
70BC04XPP30	414SFF
70BC10X30	114KS
70BC10XD30	114KSZ
70BC10XDD30	114KSZZ
70BC10XDDG30	114KSZZG
70BC10XDYG30	114KSZG
70BC10XP30	114KSF
70BC10XPP30	114KSFF
70BC10XPPG30	114KSFFG
70BC10XPYG30	114KSFG
70BC10XXYG30	114KSG
70BC19X30	1914S
70BC19XD30	1914SZ
70BC19XDD30	1914SZZ
70BC19XP30	1914SF
70BC19XPP30	1914SFF
70BC32XDD30	214SZZC
70BC32XDDG30	214SZZCG
70BC32XPP30	214SFFC
70BC32XPPG30	214SFFCG
70BC33XDD30	314SZZC
70BC33XDDG30	314SZZCG
70BC33XPP30	314SFFC
70BC33XPPG30	314SFFCG
75BC02X30	215S
75BC02XD30	215SZ
75BC02XDD30	215SZZ
75BC02XDDG30	215SZZG
75BC02XDYG30	215SZG
75BC02XP30	215SF
75BC02XPP30	215SFF
75BC02XPPG30	215SFFG
75BC02XPYG30	215SFG
75BC02XXYG30	215SG
75BC03X30	315S
75BC03XD30	315SZ
75BC03XDD30	315SZZ

ABMA Numbers and MRC Equivalent

MRC Bearing Services

ABMA Number	Bearing Size
75BC03XDDG30	315SZG
75BC03DXG30	315SZG
75BC03XP30	315SF
75BC03XPP30	315SFF
75BC03XPPG30	315SFFG
75BC03XPXG30	315SFG
75BC03XXG30	315SG
75BC04X30	415S
75BC04XD30	415SZ
75BC04XDD30	415SZZ
75BC04XP30	415SF
75BC04XPP30	415SFF
75BC10X30	115KS
75BC10XD30	115KSZ
75BC10XDD30	115KSZZ
75BC10XDDG30	115KSZZG
75BC10DXG30	115KSZG
75BC10XP30	115KSF
75BC10XPP30	115KSFF
75BC10XPPG30	115KSFFG
75BC10XPXG30	115KSFG
75BC10XXG30	115KSG
75BC19X30	1915S
75BC19XD30	1915SZ
75BC19XDD30	1915SZZ
75BC19XP30	1915SF
75BC19XPP30	1915SFF
75BC32XDD30	215SZZC
75BC32XDDG30	215SZZCG
75BC32XPP30	215SFFC
75BC32XPPG30	215SFFCG
75BC33XDD30	315SZZC
75BC33XDDG30	315SZZCG
75BC33XPP30	315SFFC
75BC33XPPG30	315SFFCG
80BC02X30	216S
80BC02XD30	216SZ
80BC02XDD30	216SZZ
80BC02XDDG30	216SZZG
80BC02DXG30	216SZG
80BC02XP30	216SF
80BC02XPP30	216SFF

ABMA Number	Bearing Size
80BC02XPPG30	216SFFG
80BC02XPXG30	216SFG
80BC02XXG30	216SG
80BC03X30	316S
80BC03XD30	316SZ
80BC03XDD30	316SZZ
80BC03XDDG30	316SZZG
80BC03DXG30	316SZG
80BC03XP30	316SF
80BC03XPP30	316SFF
80BC03XPPG30	316SFFG
80BC03XPXG30	316SFG
80BC03XXG30	316SG
80BC04X30	416S
80BC04XD30	416SZ
80BC04XDD30	416SZZ
80BC04XP30	416SF
80BC04XPP30	416SFF
80BC10X30	116KS
80BC10XD30	116KSZ
80BC10XDD30	116KSZZ
80BC10XDDG30	116KSZZG
80BC10DXG30	116KSZG
80BC10XP30	116KSF
80BC10XPP30	116KSFF
80BC10XPPG30	116KSFFG
80BC10XPXG30	116KSFG
80BC10XXG30	116KSG
80BC19X30	1916S
80BC19XD30	1916SZ
80BC19XDD30	1916SZZ
80BC19XP30	1916SF
80BC19XPP30	1916SFF
80BC32XDD30	216SZZC
80BC32XDDG30	216SZZCG
80BC32XPP30	216SFFC
80BC32XPPG30	216SFFCG
80BC33XDD30	316SZZC
80BC33XDDG30	316SZZCG
80BC33XPP30	316SFFC
80BC33XPPG30	316SFFCG
85BC02X30	217S

ABMA Number	Bearing Size
85BC02XD30	217SZ
85BC02XDD30	217SZZ
85BC02XDDG30	217SZZG
85BC02XDYG30	217SZG
85BC02XP30	217SF
85BC02XPP30	217SFF
85BC02XPPG30	217SFFG
85BC02XPYG30	217SFG
85BC02XXG30	217SG
85BC03X30	317S
85BC03XD30	317SZ
85BC03XDD30	317SZZ
85BC03XDDG30	317SZZG
85BC03XDYG30	317SZG
85BC03XP30	317SF
85BC03XPP30	317SFF
85BC03XPPG30	317SFFG
85BC03XPYG30	317SFG
85BC03XXG30	317SG
85BC04X30	417S
85BC04XD30	417SZ
85BC04XDD30	417SZZ
85BC04XP30	417SF
85BC04XPP30	417SFF
85BC10X30	117KS
85BC10XD30	117KSZ
85BC10XDD30	117KSZZ
85BC10XDDG30	117KSZZG
85BC10XDYG30	117KSZG
85BC10XP30	117KSF
85BC10XPP30	117KSFF
85BC10XPPG30	117KSFFG
85BC10XPYG30	117KSFG
85BC10XXG30	117KSG
85BC19X30	1917S
85BC19XD30	1917SZ
85BC19XDD30	1917SZZ
85BC19XP30	1917SF
85BC19XPP30	1917SFF
85BC32XDD30	217SZZC
85BC32XDDG30	217SZZCG
85BC32XPP30	217SFFC

ABMA Number	Bearing Size
85BC32XPPG30	217SFFCG
85BC33XDD30	317SZZC
85BC33XDDG30	317SZZCG
85BC33XPP30	317SFFC
85BC33XPPG30	317SFFCG
90BC02X30	218S
90BC02XD30	218SZ
90BC02XDD30	218SZZ
90BC02XDDG30	218SZZG
90BC02XDYG30	218SZG
90BC02XP30	218SF
90BC02XPP30	218SFF
90BC02XPPG30	218SFFG
90BC02XPYG30	218SFG
90BC02XXG30	218SG
90BC03X30	318S
90BC03XD30	318SZ
90BC03XDD30	318SZZ
90BC03XDDG30	318SZZG
90BC03XDYG30	318SZG
90BC03XP30	318SF
90BC03XPP30	318SFF
90BC03XPPG30	318SFFG
90BC03XPYG30	318SFG
90BC03XXG30	318SG
90BC04X30	418S
90BC04XD30	418SZ
90BC04XDD30	418SZZ
90BC04XDDG30	418SZZG
90BC04XDYG30	418SZG
90BC04XP30	418SF
90BC04XPP30	418SFF
90BC04XPPG30	418SFFG
90BC04XPYG30	418SFG
90BC10X30	118KS
90BC10XD30	118KSZ
90BC10XDD30	118KSZZ
90BC10XDDG30	118KSZZG
90BC10XDYG30	118KSZG
90BC10XP30	118KSF
90BC10XPP30	118KSFF
90BC10XPPG30	118KSFFG
90BC10XPYG30	118KSFG
90BC10XXG30	118KSG
90BC19X30	1918S
90BC19XD30	1918SZ

ABMA Numbers and MRC Equivalent

MRC Bearing Services

ABMA Number	Bearing Size
90BC19XDD30	1918SZZ
90BC19XP30	1918SF
90BC19XPP30	1918SFF
90BC32XDD30	218SZZC
90BC32XDDG30	218SZZCG
90BC32XPP30	218SFFC
90BC32XPPG30	218SFFCG
90BC33XDD30	318SZZC
90BC33XDDG30	318SZZCG
90BC33XPP30	318SFFC
90BC33XPPG30	318SFFCG
95BC02X30	219S
95BC02XD30	219SZ
95BC02XDD30	219SZZ
95BC02XDDG30	219SZZG
95BC02DXG30	219SZG
95BC02XP30	219SF
95BC02XPP30	219SFF
95BC02XPPG30	219SFFG
95BC02XPXG30	219SFG
95BC02XXG30	219SG
95BC03X30	319S
95BC03XD30	319SZ
95BC03XDD30	319SZZ
95BC03XDDG30	319SZZG
95BC03DXG30	319SZG
95BC03XP30	319SF
95BC03XPP30	319SFF
95BC03XPPG30	319SFFG
95BC03XPXG30	319SFG
95BC03XXG30	319SG
95BC04X30	419S
95BC04XD30	419SZ
95BC04XDD30	419SZZ
95BC04XP30	419SF
95BC04XPP30	419SFF
95BC10X30	119KS
95BC10XD30	119KSZ
95BC10XDD30	119KSZZ
95BC10XDDG30	119KSZZG
95BC10DXG30	119KSZG
95BC10XP30	119KSF

ABMA Number	Bearing Size
95BC10XPP30	119KSFF
95BC10XPPG30	119KSFFG
95BC10XPXG30	119KSFG
95BC10XXG30	119KSG
95BC19X30	1919S
95BC19XD30	1919SZ
95BC19XDD30	1919SZZ
95BC19XP30	1919SF
95BC19XPP30	1919SFF
95BC32XDD30	219SZZC
95BC32XDDG30	219SZZCG
95BC32XPP30	219SFFC
95BC32XPPG30	219SFFCG
95BC33XDD30	319SZZC
95BC33XDDG30	319SZZCG
95BC33XPP30	319SFFC
95BC33XPPG30	319SFFCG
100BC02X30	220S
100BC02XD30	220SZ
100BC02XDD30	220SZZ
100BC02XDDG30	220SZZG
100BC02DXG30	220SZG
100BC02XP30	220SF
100BC02XPP30	220SFF
100BC02XPPG30	220SFFG
100BC02XPXG30	220SFG
100BC02XXG30	220SG
100BC03X30	320S
100BC03XD30	320SZ
100BC03XDD30	320SZZ
100BC03XDDG30	320SZZG
100BC03DXG30	320SZG
100BC03XP30	320SF
100BC03XPP30	320SFF
100BC03XPPG30	320SFFG
100BC03XPXG30	320SFG
100BC03XXG30	320SG
100BC04X30	420S
100BC04XD30	420SZ
100BC04XDD30	420SZZ
100BC04XP30	420SF
100BC04XPP30	420SFF

ABMA Number	Bearing Size
100BC10X30	120KS
100BC10XD30	120KSZ
100BC10XDD30	120KSZZ
100BC10XDDG30	120KSZZG
100BC10XDXG30	120KSZG
100BC10XP30	120KSF
100BC10XPP30	120KSFF
100BC10XPPG30	120KSFFG
100BC10XPXG30	120KSFG
100BC10XXG30	120KSG
100BC19X30	1920S
100BC19XD30	1920SZ
100BC19XDD30	1920SZZ
100BC19XP30	1920SF
100BC19XPP30	1920SFF
100BC32XDD30	220SZZC
100BC32XDDG30	220SZZCG
100BC32XPP30	220SFFC
100BC32XPPG30	220SFFCG
100BC33XDD30	320SZZC
100BC33XDDG30	320SZZCG
100BC33XPP30	320SFFC
100BC33XPPG30	320SFFCG

**Recommended Shaft And Housing Limits
for Electric Motor Quality Bearings**

MRC Bearing Services

Shaft-ISO j5
Housing (Fixed End)-ISO H6
Housing (Floating end)-Looser fit to provide axial
adjustment

Bearing Size	Shaft Diameter (j5)		Fit in .0001"	Fixed End Housing Diameter (H6)		Fit in .0001"	Floating End Housing Diameter		Fit in .0001"
	Max	Min		Max	Min		Max	Min	
R8	.5002	.4999	1L-5T	1.1255	1.1250	9L-0	1.1258	1.1253	12L-3L
R10	.6252	.6249	1L-5T	1.3755	1.3750	10L-0	1.3758	1.3753	13L-3L
R12	.7502	.7548	2L-6T	1.6255	1.6250	10L-0	1.6258	1.6253	13L-3L
R14	.8752	.8748	2L-6T	1.8755	1.8750	10L-0	1.8758	1.8753	13L-3L
R16	1.0002	.9998	2L-6T	2.0007	2.0000	12L-0	2.0010	2.0003	15L-3L
R18	1.1252	1.1248	2L-6T	2.1257	2.1250	12L-0	2.1260	2.1253	15L-3L
R20	1.2502	1.2548	2L-7T	2.2507	2.2500	12L-0	2.2510	2.2503	15L-3L
R24	1.5002	1.4998	2L-7T	2.6257	2.6250	12L-0	2.6260	2.6253	15L-3L
1902S	.5908	.5905	1L-5T	1.1029	1.1024	9L-0	1.1032	1.1027	12L-3L
1903S	.6695	.6692	1L-5T	1.1816	1.1811	9L-0	1.1819	1.1814	12L-3L
1904S	.7876	.7872	2L-6T	1.4573	1.4567	10L-0	1.4575	1.4570	13L-3L
1905S	.9845	.9841	2L-6T	1.6541	1.6535	10L-0	1.6543	1.6538	13L-3L
1906S	1.1813	1.1809	2L-6T	1.8510	1.8504	10L-0	1.8512	1.8507	13L-3L
1907S	1.3782	1.3778	2L-7T	2.1661	2.1654	12L-0	2.1664	2.1657	15L-3L
1908S	1.5750	1.5746	2L-7T	2.4416	2.4409	12L-0	2.4419	2.4412	15L-3L
1909S	1.7719	1.7716	2L-7T	2.6779	2.6772	12L-0	2.6782	2.6775	15L-3L
1910S	1.9687	1.9683	2L-7T	2.8353	2.8346	12L-0	2.8356	2.8349	15L-3L
1911S	2.1656	2.1651	3L-8T	3.1503	3.1496	12L-0	3.1507	3.1500	16L-4L
1912S	2.3624	2.3619	3L-8T	3.3474	3.3465	15L-0	3.3478	3.3469	19L-4L
1913S	2.5593	2.5588	3L-8T	3.5442	3.5433	15L-0	3.5446	3.5437	19L-4L
1914S	2.7561	2.7556	3L-8T	3.9379	3.9370	15L-0	3.9383	3.9374	19L-4L
1915S	2.9530	2.9525	3L-8T	4.1348	4.1339	15L-0	4.1352	4.1343	19L-4L
1916S	3.1498	3.1493	3L-8T	4.3316	4.3307	15L-0	4.3320	4.3311	19L-4L
1917S	3.3467	3.3461	4L-10T	4.7253	4.7244	15L-0	4.7257	4.7248	19L-4L
1918S	3.5435	3.5429	4L-10T	4.9223	4.9213	17L-0	4.9226	4.9217	21L-4L
1919S	3.7404	3.7398	4L-10T	5.1191	5.1181	17L-0	5.1195	5.1186	22L-5L
1920S	3.9372	3.9366	4L-10T	5.5128	5.5118	17L-0	5.5132	5.5123	22L-5L
102KS	.5908	.5905	1L-5T	1.2604	1.2598	10L-0	1.2606	1.2601	13L-3L
103KS	.6695	.6692	1L-5T	1.3786	1.3780	10L-0	1.3788	1.3783	13L-3L
104KS	.7876	.7872	2L-6T	1.6541	1.6535	10L-0	1.6543	1.6538	13L-3L
105KS	.9845	.9841	2L-6T	1.8510	1.8504	10L-0	1.8512	1.8507	13L-3L
106KS	1.1813	1.1809	2L-6T	2.1661	2.1654	12L-0	2.1664	2.1657	15L-3L
107KS	1.3782	1.3778	2L-7T	2.4416	2.4409	12L-0	2.4419	2.4412	15L-3L
108KS	1.5750	1.5746	2L-7T	2.6779	2.6772	12L-0	2.6782	2.6775	15L-3L
109KS	1.7719	1.7716	2L-7T	2.9535	2.9528	12L-0	2.9538	2.9531	15L-3L
110KS	1.9687	1.9683	2L-7T	3.1503	3.1496	12L-0	3.1507	3.1500	16L-4L
111KS	2.1656	2.1651	3L-8T	3.5442	3.5433	15L-0	3.5446	3.5437	19L-4L
112KS	2.3624	2.3619	3L-8T	3.7411	3.7402	15L-0	3.7415	3.7406	19L-4L
113KS	2.5593	2.5588	3L-8T	3.9379	3.9370	15L-0	3.9383	3.9374	19L-4L
114KS	2.7561	2.7556	3L-8T	4.3316	4.3307	15L-0	4.3320	4.3311	19L-4L
115KS	2.9530	2.9525	3L-8T	4.5283	4.5276	15L-0	4.5289	4.5280	19L-4L
116KS	3.1493	3.1493	3L-8T	4.9223	4.9213	17L-0	4.9226	4.9217	21L-4L
117KS	3.3467	3.3461	4L-10T	5.1191	5.1181	17L-0	5.1195	5.1186	22L-5L
118KS	3.5435	3.5429	4L-10T	5.5128	5.5118	17L-0	5.5132	5.5123	22L-5L
119KS	3.7404	3.7398	4L-10T	5.7097	5.7087	17L-0	5.7101	5.7092	22L-5L
120KS	3.9372	3.9366	4L-10T	5.9065	5.9055	17L-0	5.9069	5.9060	22L-5L
202S	.5908	.5905	1L-5T	1.3786	1.3780	10L-0	1.3788	1.3783	13L-3L
203S	.6695	.6692	1L-5T	1.5753	1.5748	10L-0	1.5756	1.5751	13L-3L
204S	.7876	.7872	2L-6T	1.8510	1.8504	10L-0	1.8512	1.8507	13L-3L
205S	.9845	.9841	2L-6T	2.0479	2.0472	12L-0	2.0482	2.0475	15L-3L
206S	1.1813	1.1809	2L-6T	2.4416	2.4409	12L-0	2.4419	2.4412	15L-3L

Shaft-ISO j5
Housing (Fixed end)-ISO H6
Housing (Floating End)-Looser fit to provide axial adjustment

Bearing Size	Shaft Diameter (j5)		Fit in .0001"	Fixed End Housing Diameter (H6)		Fit in .0001"	Floating End Housing Diameter		Fit in .0001"
	Max	Min		Max	Min		Max	Min	
	207S	1.3782		1.3778	2L-7T		2.8353	2.8346	
208S	1.5750	1.5746	2L-7T	3.1503	3.1496	12L-0	3.1507	3.1500	16L-4L
209S	1.7719	1.7716	2L-7T	3.3474	3.3465	15L-0	3.3478	3.3469	19L-4L
210S	1.9687	1.9683	2L-7T	3.5442	3.5433	15L-0	3.5446	3.5437	19L-4L
211S	2.1656	2.1651	3L-8T	3.9379	3.9370	15L-0	3.9383	3.9374	19L-4L
212S	2.3624	2.3619	3L-8T	4.3316	4.3307	15L-0	4.3320	4.3311	19L-4L
213S	2.5593	2.5588	3L-8T	4.7253	4.7244	15L-0	4.7257	4.7248	19L-4L
214S	2.7561	2.7556	3L-8T	4.9223	4.9213	17L-0	4.9226	4.9217	21L-4L
215S	2.9530	2.9525	3L-8T	5.1191	5.1181	17L-0	5.1195	5.1186	22L-5L
216S	3.1498	3.1493	3L-8T	5.5128	5.5118	17L-0	5.5132	5.5123	22L-5L
217S	3.3467	3.3461	4L-10T	5.9065	5.9055	17L-0	5.9069	5.9060	22L-5L
218S	3.5435	3.5429	4L-10T	6.3002	6.2992	20L-0	6.3007	6.2997	25L-5L
219S	3.7404	3.7398	4L-10T	6.6939	6.6929	20L-0	6.6944	6.6934	25L-5L
220S	3.9372	3.9366	4L-10T	7.0876	7.0866	20L-0	7.0881	7.0871	25L-5L
302S	.5908	.5905	1L-5T	1.6541	1.6535	10L-0	1.6543	1.6538	13L-3L
303S	.6695	.6692	1L-5T	1.8510	1.8504	10L-0	1.8512	1.8507	13L-3L
304S	.7876	.7872	2L-6T	2.0479	2.0472	12L-0	2.0482	2.0475	15L-3L
305S	.9845	.9841	2L-6T	2.4416	2.4409	12L-0	2.4419	2.4412	15L-3L
306S	1.1813	1.1809	2L-6T	2.8353	2.8346	12L-0	2.8356	2.8349	15L-3L
307S	1.3782	1.3778	2L-7T	3.1503	3.1496	12L-0	3.1507	3.1500	16L-4L
308S	1.5750	1.5746	2L-7T	3.5442	3.5433	15L-0	3.5446	3.5437	19L-4L
309S	1.7719	1.7716	2L-7T	3.9379	3.9370	15L-0	3.9383	3.9374	19L-4L
310S	1.9687	1.9683	2L-7T	4.3316	4.3307	15L-0	4.3320	4.3311	19L-4L
311S	2.1656	2.1651	3L-8T	4.7253	4.7244	15L-0	4.7257	4.7248	19L-4L
312S	2.3624	2.3619	3L-8T	5.1191	5.1181	17L-0	5.1195	5.1186	22L-5L
313S	2.5593	2.5588	3L-8T	5.5128	5.5118	17L-0	5.5132	5.5123	22L-5L
314S	2.7561	2.7556	3L-8T	5.9065	5.9055	17L-0	5.9069	5.9060	22L-5L
315S	2.9530	2.9525	3L-8T	6.3002	6.2992	20L-0	6.3007	6.2997	25L-5L
316S	3.1498	3.1493	3L-8T	6.6939	6.6929	20L-0	6.6944	6.6934	25L-5L
317S	3.3467	3.3461	4L-10T	7.0876	7.0866	20L-0	7.0881	7.0871	25L-5L
318S	3.5435	3.5429	4L-10T	7.4814	7.4803	23L-0	7.4819	7.4808	28L-5L
319S	3.7404	3.7398	4L-10T	7.8751	7.8740	23L-0	7.8756	7.8745	28L-5L
320S	3.9372	3.9366	4L-10T	8.2688	8.2677	23L-0	8.2693	8.2682	28L-5L
403S	.6695	.6692	1L-5T	2.4416	2.4409	12L-0	2.4419	2.4412	15L-3L
404S	.7876	.7872	2L-6T	2.8353	2.8346	12L-0	2.8356	2.8349	15L-3L
405S	.9845	.9841	2L-6T	3.1503	3.1496	12L-0	3.1507	3.1500	16L-4L
406S	1.1813	1.1809	2L-6T	3.5442	3.5433	15L-0	3.5446	3.5437	19L-4L
407S	1.3782	1.3778	2L-7T	3.9379	3.9370	15L-0	3.9383	3.9374	19L-4L
408S	1.5750	1.5746	2L-7T	4.3316	4.3307	15L-0	4.3320	4.3311	19L-4L
409S	1.7719	1.7716	2L-7T	4.7253	4.7244	15L-0	4.7257	4.7248	19L-4L
410S	1.9687	1.9683	2L-7T	5.1191	5.1181	17L-0	5.1195	5.1186	22L-5L
411S	2.1656	2.1651	3L-8T	5.5128	5.5118	17L-0	5.5132	5.5123	22L-5L
412S	2.3624	2.3619	3L-8T	5.9065	5.9055	17L-0	5.9069	5.9060	22L-5L
413S	2.5593	2.5588	3L-8T	6.3002	6.2992	20L-0	6.3007	6.2997	25L-5L
414S	2.7561	2.7556	3L-8T	7.0876	7.0866	20L-0	7.0881	7.0871	25L-5L
415S	2.9530	2.9525	3L-8T	7.4814	7.4803	23L-0	7.4819	7.4808	28L-5L
416S	3.1498	3.1493	3L-8T	7.8751	7.8740	23L-0	7.8756	7.8745	28L-5L
417S	3.3467	3.3461	4L-10T	8.2688	8.2677	23L-0	8.2693	8.2682	28L-5L
418S	3.5435	3.5429	4L-10T	8.6625	8.6615	23L-0	8.6630	8.6620	28L-5L
419S	3.7404	3.7398	4L-10T	9.0562	9.0552	23L-0	9.0567	9.0557	28L-5L
420S	3.9372	3.9366	4L-10T	9.4499	9.4489	27L-0	9.4504	9.4494	32L-5L

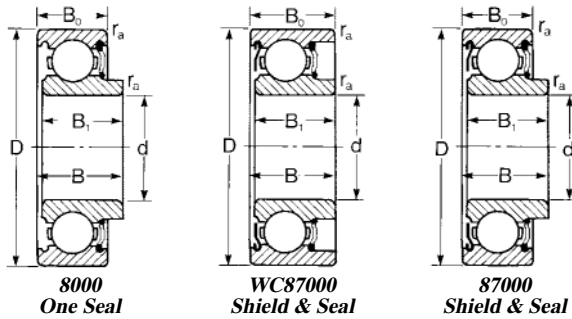

MRC Felt Seal Replacement Bearings have synthetic rubber seals.

MRC Bearing Number	Old MRC Bearing Number	Bore		Outside Diameter D		Width						Fillet Radius ¹⁾		ZD ²⁾		Basic Radial Load Rating				Speed Rating ²⁾ Single and Double Sealed Grease RPM
						B ₀		B ₁		B						Dynamic C ³⁾		Static C ₀		
						mm	in	mm	in	mm	in					N	lbf	N	lbf	
8008	38FS1	8	.3150	24	.9449	8	.315	9.8	.386	10.3	.406	.30	.012	110	.17	3 320	746	1 430	321	23 000
8013	201FS2	13	.5118	32	1.2598	10	.394	12.2	.480	12.7	.500	.64	.025	245	.38	6 890	1 550	3 050	686	15 000
8014	202FS1	14	.5512	35	1.3780	11	.433	12.2	.480	12.7	.500	.64	.025	284	.44	7 610	1 710	3 650	821	13 000
8016	202FS3	16	.6299	35	1.3780	11	.433	12.2	.480	12.7	.500	.64	.025	284	.44	7 610	1 710	3 650	821	13 000
8026	205FS3	26	1.0236	52	2.0472	15	.591	15.2	.600	15.9	.625	1.0	.040	568	.88	14 000	3 150	8 000	1 800	8 500
8038	38FS	8	.3150	22	.8661	8	.315	9.8	.386	10.3	.406	.30	.012	110	.17	3 320	746	1 370	308	23 000
8500	200FS	10	.3937	30	1.1811	9	.354	12.2	.480	12.7	.500	.64	.025	155	.24	5 070	1 140	2 400	540	17 000
8501	201FS	12	.4724	32	1.2598	10	.394	12.2	.480	12.7	.500	.64	.025	245	.38	6 760	1 520	3 050	685	15 000
8502	202FS	15	.5906	35	1.3780	11	.433	12.2	.480	12.7	.500	.64	.025	277	.43	7 610	1 710	3 750	843	13 000
8503	203FS	17	.6693	40	1.5748	12	.472	13.7	.538	14.3	.563	.64	.025	361	.56	9 560	2 150	4 800	1 080	12 000
8504	204FS	20	.7874	47	1.8504	14	.551	15.2	.600	15.9	.625	1.0	.040	503	.78	13 000	2 920	6 700	1 510	10 000
8505	205FS	25	.9843	52	2.0472	15	.591	15.2	.600	15.9	.625	1.0	.040	568	.88	14 000	3 150	8 000	1 800	8 500
8506	206FS	30	1.1811	62	2.4409	16	.630	19	.748	20	.787	1.0	.040	813	1.26	19 500	4 380	11 400	2 560	7 500
8507	207FS	35	1.3780	72	2.8346	17	.669	20	.787	21	.827	1.0	.040	1 109	1.72	25 500	5 730	15 300	3 440	6 300
8508	208FS	40	1.5748	80	3.1496	21	.827	24	.945	24	.945	1.0	.040	1 320	2.05	29 100	6 540	18 000	4 050	5 600
8605	305FS	25	.9843	62	2.4409	17	.669	21	.827	21	.827	1.0	.040	632	.98	15 900	3 570	8 000	1 800	7 500
WC87008	38FSF2	8	.3150	24	.9449	10.3	.406	9.8	.386	10.3	.406	.30	.012	110	.17	3 320	746	1 430	321	23 000
WC87016	16	.6299	35	1.3780	12.7	.500	12.2	.480	12.7	.500	.64	.025	284	.44	7 610	1 710	3 750	843	13 000	
WC87500	200FSF1	10	.3937	30	1.1811	12.7	.500	12.2	.480	12.7	.500	.64	.025	155	.24	5 070	1 140	2 400	540	17 000
WC87501	201FSF1	12	.4724	32	1.2598	12.7	.500	12.2	.480	12.7	.500	.64	.025	245	.38	6 890	1 550	2 400	540	15 000
WC87502	202FSF1	15	.5906	35	1.3780	12.7	.500	12.2	.480	12.7	.500	.64	.025	277	.43	7 610	1 710	3 750	843	13 000
WC87503	203FSF1	17	.6693	40	1.5748	14.3	.563	13.7	.538	14.3	.563	.64	.025	361	.56	9 560	2 150	4 800	1 080	12 000
WC87504	204FSF1	20	.7874	47	1.8504	15.9	.625	15.2	.600	15.9	.625	1.0	.040	503	.78	13 000	2 920	6 700	1 510	10 000
87007	37FSF1	7	.2756	24	.9449	8	.315	9.8	.386	10.3	.406	.30	.012	110	.17	3 320	746	1 430	321	23 000
87008	38FSF1	8	.3150	24	.9449	8	.315	9.8	.386	10.3	.406	.30	.012	110	.17	3 320	746	1 430	321	23 000
87013	201FSF3	13	.5118	32	1.2598	10	.394	12.2	.480	12.7	.500	.64	.025	245	.38	6 890	1 550	3 050	686	15 000
87014	14	.5512	35	1.3780	11	.433	12.2	.480	12.7	.500	.64	.025	284	.44	7 610	1 710	3 650	821	13 000	
87016	202FSF4	16	.6299	35	1.3780	11	.433	12.2	.480	12.7	.500	.64	.025	284	.44	7 610	1 710	3 750	843	13 000
87026	26	1.0236	52	2.0472	15	.591	15.2	.600	15.9	.625	1.0	.040	568	.88	14 000	3 150	8 000	1 800	8 500	
87036	36FSF	6	.2362	19	.7480	8	.315	9.8	.386	10.3	.406	.30	.012	97	.15	2 810	632	1 080	243	26 000
87037	37FSF	7	.2756	22	.8661	8	.315	9.8	.386	10.3	.406	.30	.012	110	.17	3 320	746	1 340	301	23 000
87038	38FSF	8	.3150	22	.8661	8	.315	9.8	.386	10.3	.406	.30	.012	110	.17	3 320	746	1 370	308	23 000
87500	200FSF	10	.3937	30	1.1811	9	.354	12.2	.480	12.7	.500	.64	.025	155	.24	5 070	1 140	2 400	540	17 000
87501	201FSF	12	.4724	32	1.2598	9	.394	12.2	.480	12.7	.500	.64	.025	245	.38	8 190	1 840	3 650	821	15 000
87502	202FSF	15	.5906	35	1.3780	11	.433	12.2	.480	12.7	.500	.64	.025	277	.43	7 610	1 710	3 750	843	13 000
87503	203FSF	17	.6693	40	1.5748	12	.472	13.7	.538	14.3	.563	.64	.025	361	.56	9 560	2 150	4 800	1 080	12 000
87504	204FSF	20	.7874	47	1.8504	14	.551	15.2	.600	15.9	.625	1.0	.040	503	.78	13 000	2 920	6 700	1 510	10 000
87505	205FSF	25	.9843	52	2.0472	15	.591	15.2	.600	15.9	.625	1.0	.040	568	.88	14 000	3 150	8 000	1 800	8 500
87506	206FSF	30	1.1811	62	2.4409	16	.630	19	.748	20	.787	1.0	.040	813	1.26	19 500	4 380	11 400	2 560	7 500
87507	207FSF	35	1.3780	72	2.8346	17	.669	20	.787	21	.827	1.0	.040	1 110	1.72	25 500	5 730	15 300	3 440	6 300
87508	208FSF	40	1.5748	80	3.1496	21	.827	24	.945	24	.945	1.0	.040	1 320	2.05	29 100	6 540	18 000	4 050	5 000

¹⁾ Fillet radius indicates maximum fillet radius on shaft or in housing which bearing corner will clear.

²⁾ Listed values are for pressed steel or polyamide cage, ABEC-1.

The values have been determined through historical application and practice. For a more complete explanation, see page 276.

³⁾ Rating for one million revolutions or 500 hours at 33 1/3 RPM.

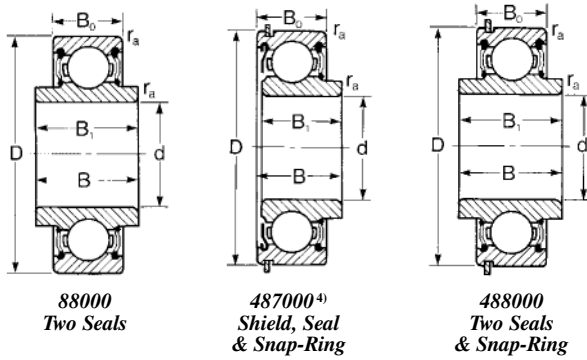

MRC Felt Seal Replacement Bearings have synthetic rubber seals.

MRC Bearing Number	Old MRC Bearing Number	Bore		Outside Diameter D		Width						Fillet Radius ¹⁾		ZD ²⁾		Basic Radial Load Rating				Speed Rating ²⁾ Single and Double Sealed Grease RPM		
						B ₀			B ₁							B		Dynamic C ³⁾			Static C ₀	
						mm	in	mm	in	mm	in					mm	in	N	lbf		N	lbf
88007	38FFS2	7	.2756	24	.9449	8	.315	12.6	.497	12.6	.497	.30	.012	110	.17	3 320	746	1 430	321	23 000		
88008		8	.3150	24	.9449	8	.315	12.6	.497	12.6	.497	.30	.012	110	.17	3 320	746	1 430	321	23 000		
88009		9	.3543	30	1.1811	8	.354	16.4	.646	16.4	.646	.64	.025	155	.24	4 620	1 040	2 040	459	17 000		
88011	201FFS2	11	.4331	32	1.2598	10	.394	15.4	.606	15.4	.606	.64	.025	245	.38	6 760	1 520	3 000	674	15 000		
88013		13	.5118	32	1.2598	10	.394	15.4	.606	15.4	.606	.64	.025	245	.38	6 890	1 550	3 050	686	15 000		
88016		202FFS5	16	.6299	35	1.3780	11	.433	14.4	.567	14.4	.567	.64	.025	284	.44	7 610	1 710	3 750	843	13 000	
88500	200FFS	10	.3937	30	1.1811	9	.354	16.4	.646	16.4	.646	.64	.025	155	.24	5 070	1 140	2 400	540	17 000		
88501	201FFS	12	.4724	32	1.2598	10	.394	15.4	.606	15.4	.606	.64	.025	245	.38	6 760	1 520	3 050	685	15 000		
88502	202FFS	15	.5906	35	1.3780	11	.433	14.4	.567	14.4	.567	.64	.025	277	.43	7 610	1 710	3 750	843	13 000		
88503	203FFS	17	.6693	40	1.5748	12	.472	16.6	.654	16.6	.654	.64	.025	361	.56	9 560	2 150	4 800	1 080	12 000		
88504	204FFS	20	.7874	47	1.8504	14	.551	17.8	.699	17.8	.699	1.0	.040	503	.78	13 000	2 920	6 700	1 510	10 000		
88505	205FFS	25	.9843	52	2.0472	15	.591	16.7	.659	16.7	.659	1.0	.040	568	.88	14 000	3 150	8 000	1 800	8 500		
88506	206FFS	30	1.1811	62	2.4409	16	.630	24	.945	24	.945	1.0	.040	813	1.26	19 500	4 380	11 400	2 560	7 500		
88507	207FFS	35	1.3780	72	2.8346	17	.669	25	.984	25	.984	1.0	.040	1 110	1.72	25 500	5 730	15 300	3 440	6 300		
88508	208FFS	40	1.5748	80	3.1496	21	.827	27	1.063	27	1.063	1.0	.040	1 320	2.05	29 100	6 540	18 000	4 050	5 600		
487502	G202FSF	15	.5906	35	1.3780	11	.433	12.2	.480	12.7	.500	.64	.025	277	.43	7 610	1 710	3 750	843	13 000		
487503	G203FSF	17	.6693	40	1.5748	12	.472	13.7	.538	14.3	.563	.64	.025	361	.56	9 560	2 150	4 800	1 080	12 000		
487508	G208FSF	40	1.5748	80	3.1496	21	.827	24	.945	24	.945	1.0	.040	1 320	2.05	29 100	6 540	18 000	4 050	5 600		
488016	202FFS2G	16	.6299	35	1.3780	11	.433	14.4	.567	14.4	.567	.64	.025	284	.44	7 610	1 710	3 750	843	13 000		
488502	202FFS2G	15	.5906	35	1.3780	11	.433	14.4	.567	14.4	.567	.64	.025	277	.43	7 610	1 710	3 750	843	13 000		
488503	203FFS2G	17	.6693	40	1.5748	12	.472	16.6	.654	16.6	.654	.64	.025	361	.56	9 560	2 150	4 800	1 080	12 000		
488504	204FFS2G	20	.7874	47	1.8504	14	.551	17.8	.699	17.8	.699	1.0	.040	503	.78	13 000	2 920	6 700	1 510	10 000		
488505	205FFS2G	25	.9843	52	2.0472	15	.591	16.7	.659	16.7	.659	1.0	.040	568	.88	14 000	3 150	8 000	1 800	8 500		
488506	206FFS2G	30	1.1811	62	2.4409	16	.630	24	.945	24	.945	1.0	.040	813	1.26	19 500	4 380	11 400	2 560	7 500		
488507	207FFS2G	35	1.3780	72	2.8346	17	.669	25	.984	25	.984	1.0	.040	1 110	1.72	25 500	5 730	15 300	3 440	6 300		
488508	208FFS2G	40	1.5748	80	3.1496	21	.827	27	1.063	27	1.063	1.0	.040	1 320	2.05	29 100	6 540	18 000	4 050	5 600		

¹⁾ Fillet radius indicates maximum fillet radius on shaft or in housing which bearing corner will clear.

²⁾ Listed values are for pressed steel or polyamide cage, ABEC-1.

The values have been determined through historical application and practice. For a more complete explanation, see page 276.

³⁾ Rating for one million revolutions or 500 hours at 33 1/3 RPM.

⁴⁾ Add suffix "V" when snap ring is on seal side.

Felt Seal Replacement Bearings

Basic Dimensions and Interchange

MRC Bearing Services



8000
One Seal



WC87000
Shield & Seal



87000
Shield & Seal

MRC Bearing Number	Bore		Outside Diameter D		Width						Basic Interchange		
	d mm	in	mm	in	Outer Ring		Inner Ring		Overall		BCA	FAF	NDH NTN
					mm	in	mm	in	mm	in			
8008	8	.3150	24	.9449	8.0	.315	9.8	.386	10.3	.406	—	38KVL	8008
8013	13	.5118	32	1.2598	10.0	.394	12.2	.480	12.7	.500	8013	—	8013
8014	14	.5512	35	1.3780	11.0	.433	12.2	.480	12.7	.500	—	202KL4	8014
8016	16	.6299	35	1.3780	11.0	.433	12.2	.480	12.7	.500	8016	202KL3	8016
8026	26	1.0236	52	2.0472	15.0	.591	15.2	.600	15.9	.625	8026	—	8026
8038	8	.3150	22	.8661	8.0	.315	9.8	.386	10.3	.406	—	38KL	8038
8500	10	.3937	30	1.1811	9.0	.354	12.2	.480	12.7	.500	8500	200KL	8500
8501	12	.4724	32	1.2598	10.0	.394	12.2	.480	12.7	.500	8501	201KL	8501
8502	15	.5906	35	1.3780	11.0	.433	12.2	.480	12.7	.500	8502	202KL	8502
8503	17	.6693	40	1.5748	12.0	.472	13.7	.538	14.3	.563	8503	203KL	8503
8504	20	.7874	47	1.8504	14.0	.551	15.2	.600	15.9	.625	8504	204KL	8504
8505	25	.9843	52	2.0472	15.0	.591	15.2	.600	15.9	.625	8505	205KL	8505
8506	30	1.1811	62	2.4409	16.0	.630	19.0	.748	20.0	.787	8506	206KL	8506
8507	35	1.3780	72	2.8346	17.0	.669	20.0	.787	21.0	.827	8507	207KL	8507
8508	40	1.5748	80	3.1496	21.0	.827	24.0	.945	24.0	.945	8508	—	8508
8605	25	.9843	62	2.4409	17.0	.669	21.0	.827	21.0	.827	8605	—	8605
WC87008	8	.3150	24	.9449	10.3	.406	9.8	.386	10.3	.406	—	38KVD	WC87008
WC87016	16	.6299	35	1.3780	12.7	.500	12.2	.480	12.7	.500	—	202KTD3	WC87016
WC87500	10	.3937	30	1.1811	12.7	.500	12.2	.480	12.7	.500	WC87500	200KTD	WC87500
WC87501	12	.4724	32	1.2598	12.7	.500	12.2	.480	12.7	.500	WC87501	201KTD	WC87501
WC87502	15	.5906	35	1.3780	12.7	.500	12.2	.480	12.7	.500	WC87502	202KTD	WC87502
WC87503	17	.6693	40	1.5748	14.3	.563	13.7	.538	14.3	.563	WC87503	203KTD8	WC87503
WC87504	20	.7874	47	1.8504	15.9	.625	15.2	.600	15.9	.625	WC87504	—	WC87504
87007	7	.2756	24	.9449	8.0	.315	9.8	.386	10.3	.406	—	37KVD	87007
87008	8	.3150	24	.9449	8.0	.315	9.8	.386	10.3	.406	87008	38KVD	87008
87013	13	.5118	32	1.2598	10.0	.394	12.2	.480	12.7	.500	87013	201KLD2	87013
87014	14	.5512	35	1.3780	11.0	.433	12.2	.480	12.7	.500	—	—	87014
87016	16	.6299	35	1.3780	11.0	.433	12.2	.480	12.7	.500	87016	202KLD3	87016
87026	26	1.0236	52	2.0472	15.0	.591	15.2	.600	15.9	.625	—	—	87026
87036	6	.2362	19	.7480	8.0	.315	9.8	.386	10.3	.406	—	36KLD	87036
87037	7	.2756	22	.8661	8.0	.315	9.8	.386	10.3	.406	—	37KLD	87037
87038	8	.3150	22	.8661	8.0	.315	9.8	.386	10.3	.406	—	38KLD	87038
87500	10	.3937	30	1.1811	9.0	.354	12.2	.480	12.7	.500	87500	200KLD	87500
87501	12	.4724	32	1.2598	9.0	.394	12.2	.480	12.7	.500	87501	201KLD	87501
87502	15	.5906	35	1.3780	11.0	.433	12.2	.480	12.7	.500	87502	202KLD	87502
87503	17	.6693	40	1.5748	12.0	.472	13.7	.538	14.3	.563	87503	203KLD	87503
87504	20	.7874	47	1.8504	14.0	.551	15.2	.600	15.9	.625	87504	204KLD	87504
87505	25	.9843	52	2.0472	15.0	.591	15.2	.600	15.9	.625	87505	205KLD	87505
87506	30	1.1811	62	2.4409	16.0	.630	19.0	.748	20.0	.787	87506	206KLD	87506
87507	35	1.3780	72	2.8346	17.0	.669	20.0	.787	21.0	.827	87507	207KLD	87507
87508	40	1.5748	80	3.1497	21.0	.827	24.0	.945	24.0	.945	—	—	87508



88000
Two Seals



487000
Shield, Seal
& Snap-Ring

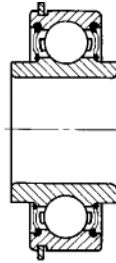

488000
Two Seals
& Snap-Ring

MRC Felt Seal Replacement Bearings have synthetic rubber seals.

MRC Bearing Number	Bore		Outside Diameter D		Width						Basic Interchange		
					Outer Ring		Inner Ring		Overall		BCA	FAF	NDH NTN
	d		mm	in	mm	in	mm	in	mm	in			
88007	7	.2756	24	.9449	8.0	.315	12.6	.497	12.6	.497	—	—	88007
88008	8	.3150	24	.9449	8.0	.315	12.6	.497	12.6	.497	—	38KVL2	88008
88009	9	.3543	30	1.1811	9.0	.354	16.4	.646	16.4	.646	—	—	88009
88011	11	.4331	32	1.2598	10.0	.394	15.4	.606	15.4	.606	—	—	88011
88013	13	.5118	32	1.2598	10.0	.394	15.4	.606	15.4	.606	88013	201KLL3	88013
88016	16	.6299	35	1.3780	11.0	.433	14.4	.567	14.4	.567	88016	202KLL3	88016
88500	10	.3937	30	1.1811	9.0	.354	16.4	.646	16.4	.646	88500	200KLL2	88500
88501	12	.4724	32	1.2598	10.0	.394	15.4	.606	15.4	.606	88501	201KLL2	88501
88502	15	.5906	35	1.3780	11.0	.433	14.4	.567	14.4	.567	88502	202KLL2	88502
88503	17	.6693	40	1.5748	12.0	.472	16.6	.654	16.6	.654	88503	203KLL2	88503
88504	20	.7874	47	1.8504	14.0	.551	17.8	.699	17.8	.699	88504	204KLL2	88504
88505	25	.9843	52	2.0472	15.0	.591	16.7	.659	16.7	.659	88505	205KLL2	88505
88506	30	1.1811	62	2.4409	16.0	.630	24.0	.945	24.0	.945	88506	206KLL	88506
88507	35	1.3780	72	2.8346	17.0	.669	25.0	.984	25.0	.984	—	207KLL	88507
88508	40	1.5748	80	3.1496	21.0	.827	27.0	1.063	27.0	1.063	88508	—	88508
487502	15	.5906	35	1.3780	11.0	.433	12.2	.480	12.7	.500	—	—	487502
487503	17	.6693	40	1.5748	12.0	.472	13.7	.538	14.3	.563	—	—	487503
487508	40	1.5748	80	3.1496	21.0	.827	24.0	.945	24.0	.945	—	—	487508
488016	16	.6299	35	1.3780	11.0	.433	14.4	.567	14.4	.567	—	—	488016
488502	15	.5906	35	1.3780	11.0	.433	14.4	.567	14.4	.567	—	—	488502
488503	17	.6693	40	1.5748	12.0	.472	16.6	.654	16.6	.654	—	—	488503
488504	20	.7874	47	1.8504	14.0	.551	17.8	.699	17.8	.699	—	—	488504
488505	25	.9843	52	2.0472	15.0	.591	16.7	.659	16.7	.659	—	—	488505
488506	30	1.1811	62	2.4409	16.0	.630	24.0	.945	24.0	.945	—	—	488506
488507	35	1.3780	72	2.8346	17.0	.669	25.0	.984	25.0	.984	—	—	488507
488508	40	1.5748	80	3.1496	21.0	.827	27.0	1.063	27.0	1.063	—	—	488508

NOTES

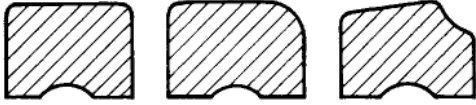

Mast Guide Type

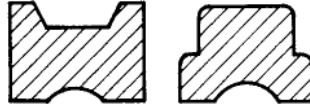

Chain Sheave Type

Outer Ring Design

Industrial truck mast guide ball bearings are a family of special bearings tailored to meet the requirements of the industrial truck industry. These bearings must be able to accommodate heavy radial loads, withstand heavy shock loads, and handle overturning moments produced by combined radial and thrust loads.

Special lubricants are selected to meet the rigorous demands of industrial truck service. To retain the lubricant and protect the bearing from adverse environmental conditions, the bearings are equipped with either synthetic rubber or polypropylene seals.

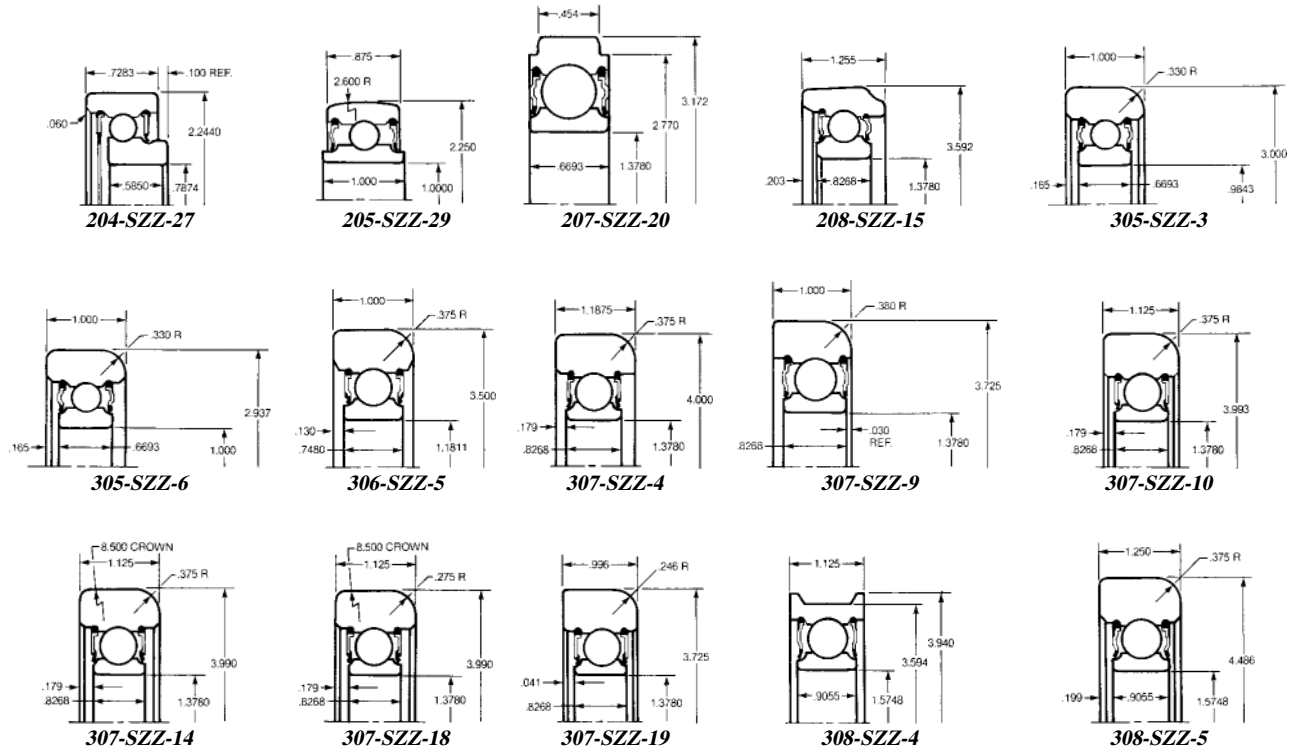

MRC Bearing Number	Basic Radial Load Rating ¹⁾						Basic Interchange ¹⁾					
	ZD ²		Dynamic C ²⁾		Static C ₀		SKF	BCA	Hoover/NSK	McGill	NDH	Split
	mm	in	N	lbf	N	lbf						
204SZZ27	459	.71	18 600	4 180	65 500	14 700	BNTB316574	—	—	—	—	—
205SZZ29	610	.95	15 300	3 440	8 150	1 830	—	—	—	—	—	—
207SZZ20	1 110	1.72	25 500	5 730	15 300	3 440	—	—	—	—	—	—
208SZZ15	1 450	2.25	52 700	11 800	216 000	48 600	—	MG207FFH	—	BB1705	—	TB104
305SZZ3	852	1.32	33 800	7 600	122 000	27 400	—	MG305DD	X421	BB849	ZMG605ATY1Z8	—
305SZZ6	852	1.32	20 800	6 770	11 200	2 520	—	MG305DDA	—	—	—	—
306SZZ5	1 290	2.00	48 800	10 970	18 000	40 500	361885	MG306DD	X555	—	—	—
307SZZ4	1 590	2.47	60 500	13 600	216 000	48 600	—	—	—	—	—	—
307SZZ9	1 590	2.47	60 500	13 600	216 000	48 600	—	MG307FFK	X549RS	—	—	—
307SZZ10	1 590	2.47	60 500	13 600	216 000	48 600	360858C	MG307FF	X3762S	BB816	Z99607BTY1Z8	—
307SZZ14	1 590	2.47	60 500	13 600	216 000	48 600	—	—	—	—	—	—
307SZZ18	1 590	2.47	60 500	13 600	216 000	48 600	—	—	—	—	—	—
307SZZ19	1 590	2.47	60 500	13 600	216 000	48 600	—	—	—	—	—	—
308SZZ4	2 020	3.13	72 800	16 400	280 000	62 900	—	—	—	—	—	—
308SZZ5	2 020	3.13	72 800	16 400	280 000	62 900	362480	EX4989	—	BB1747	—	—

¹⁾ Ratings shown have values modified to reflect raceway curvatures less than a total of 54%.

²⁾ Rating for one million revolutions or 500 hours at 33 1/3 RPM.

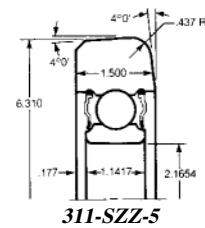
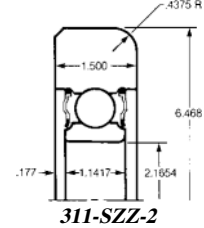
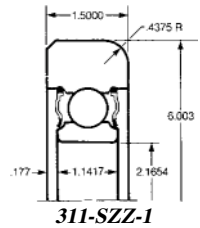
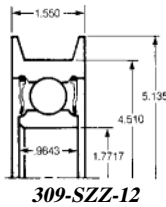
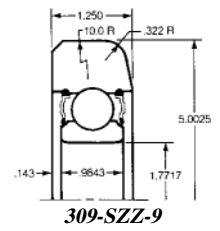
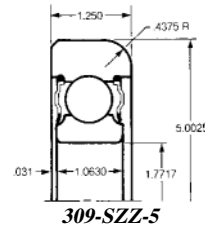
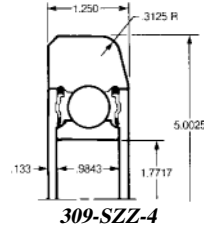
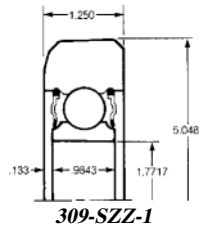
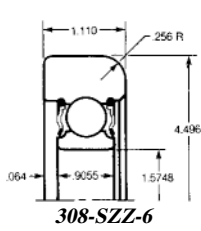

MRC Bearing Number	Basic Radial Load Rating ¹⁾						Basic Interchange					
	ZD ²		Dynamic C ²⁾		Static C ₀		SKF	BCA	Hoover/NSK	McGill	NDH	Split
	mm	in	N	lbf	N	lbf						
308SZZ6	2 020	3.13	72 800	16 400	280 000	62 900	—	—	—	—	—	—
309SZZ1	2 440	3.78	87 100	19 600	345 000	77 600	—	MG309DD	—	BB850	—	—
309SZZ4	2 440	3.78	87 100	19 600	345 000	77 600	—	MG309DDA	X501RS	BB1652	ZMG609XRY1Z8	—
309SZZ5	2 900	4.50	81 900	18 400	275 000	61 800	—	—	—	—	—	—
309SZZ9	2 440	3.78	87 100	19 600	345 000	77 600	—	—	—	—	—	—
309SZZ12	2 440	3.78	87 100	19 600	345 000	77 600	—	—	—	—	—	—
311SZZ1	3 410	5.28	71 500	16 100	44 000	9 890	—	—	—	BB16493	—	—
311SZZ2	3 410	5.28	72 800	16 400	325 000	73 100	—	—	—	—	—	—
311SZZ5	3 410	5.28	72 800	16 400	325 000	73 100	—	—	—	—	—	—

¹⁾ Ratings shown have values modified to reflect raceway curvatures less than a total of 54%.

²⁾ Rating for one million revolutions or 500 hours at 33 1/3 RPM.

Original Equipment Manufacturers Part Number Reference Guide

Original Equip. Part Number	MRC Bearing Number	Original Equip. Part Number	MRC Bearing Number	Original Equip. Part Number	MRC Bearing Number
Allis Chalmers					
1001732	208-SZZ-15				
1002841-02	5309-BZZ-1				
1005603	309-SZZ-4				
4756413	5206-BKFF-1				
4769905	5306-BZZ-1				
4774102	5108-BZZ-1				
4797550	5209-BZZ-1				
4798050	5210-BZZ-1				
4803599	5109-BZZ-2				
4803665	5109-BZZ-1				
4812920	307-SZZ-9				
4817265	207-SZZ-20				
4820659	309-SZZ-4				
4832744	311-SZZ-2				
4842106	5209-BZZ-2				
4859065	5109-BZZ-3				
4863104	5309-RZZ-1				
48206693	309-SZZ-4				
71005603	309-SZZ-4				
8612154	311-SZZ-5				
American Manufacturing Co.					
305-SZZ-3	305-SZZ-3				
305-SZZ-6	305-SZZ-6				
307-SZZ-10	307-SZZ-10				
309-SZZ-4	309-SZZ-4				
Arrow Fork Lift					
35A11111	307-SZZ-8				
305-SZZ-3	305-SZZ-3				
306-SZZ-5	306-SZZ-5				
307-SZZ-10	307-SZZ-10				
309-SZZ-1	309-SZZ-1				
309-SZZ-4	309-SZZ-4				
5108-BZZ-1	5108-BZZ-1				
5208-BTZ-1	5208-BTZ-1				
185531	208-SZZ-16				
746623	305-SZZ-3				
789401	308-SZZ-1				
4812920	307-SZZ-9				
Baker Material Handling					
102916	206-SZZ-16				
104744	309-SZZ-4				
105475	306-SZZ-5				
105476	204-SZZ-20				
120891	307-SZZ-10				
504001	307-SZZ-10				
504002	309-SZZ-4				
Barrett Electronics					
A10650	5306-BZZ-1				
A27690-2	307-SZZ-10				
Caterpillar Tractor					
091132	307-SZZ-14				
308918	305-SZZ-3				
314046	309-SZZ-9				
314047	309-SZZ-1				
346114	308-SZZ-4				
371202	307-SZZ-18				
Clark Equipment					
342957	307-SZZ-10				
665619	208-SZZ-9				
738752-J	309-SZZ-1				
746623	305-SZZ-3				
746624	307-SZZ-10				
996829	307-SZZ-10				
1654614	309-SZZ-4				
1695854	306-SZZ-5				
1697663	311-SZZ-1				
1764714	5316-SZZ-1				
2306335	307-SZZ-11				
2306336	305-SZZ-7				
2326653	308-SZZ-5				
2357128	309-SZZ-12				
2357723	308-SZZ-6				
2359625	204-SZZ-27				
2359446	5309-BZZ-2				
2359447	5307-BZZ-1				
Criterion Engineering Ltd.					
205-SZZ-29	205-SZZ-29				
305-SZZ-6	305-SZZ-6				
309-SZZ-4	309-SZZ-4				
Crown Controls					
74020-B	305-SZZ-3				
74668-1	307-SZZ-10				
79943	309-SZZ-4				
Dyna-Power Corporation					
R1	307-SZZ-10				
Eaton Corporation					
260100-18-001-00	307-SZZ-16				
Fiat-Allis					
74820659	309-SZZ-4				
74832744	311-SZZ-2				
Hyster					
87905	307-SZZ-10				
89219	5205-BKZZ-1				
129002	5206-BKZZ-1				
143493	5208-BKT-1				
185530	208-SZZ-15				
185531	208-SZZ-16				
186711	5208-BTT-2				
193557	5208-BTZ-1				
212956	307-SZZ-10				
231020	5207-BKZZ-1				
K-D Manufacturing Co.					
R2	309-SZZ-4				
R-186	5309-RZZ-1				
R 5182	308-SZZ-4				
307-SZZ-10	307-SZZ-10				
309-SZZ-1	309-SZZ-1				
Knickerbocker Co.					
30451	307-SZZ-10				
30487	305-SZZ-3				
30719	309-SZZ-4				
Massey Ferguson					
311-SZZ-1	311-SZZ-1				
672896M1	309-SZZ-1				
Pettibone Corporation					
31486	206-SZZ-16				
F11201	307-SZZ-10				
Pettibone-Mercury					
30076	206-SZZ-16				
33569	309-SZZ-4				
33799	307-SZZ-10				
Petti-Mulliken					
F11205	307-SZZ-10				
P45900	309-SZZ-4				
Raymond					
449033	309-SZZ-4				
Schreck					
31-42014	307-SZZ-10				
31-42015	309-SZZ-4				
31-43450	305-SZZ-3				
Taylor Machine Works					
309-SZZ-1	309-SZZ-1				
Towmotor Corporation See Caterpillar Tractor					
White Farm Equipment					
20-3004059	309-SZZ-5				
White Material Handling					
35A11111	307-SZZ-8				
35A12631	307-SZZ-10				
Wiggins Lift Co.					
307-SZZ-10	307-SZZ-10				
309-SZZ-1	309-SZZ-1				
309-SZZ-4	309-SZZ-4				
311-SZZ-1	311-SZZ-1				
311-SZZ-2	311-SZZ-2				

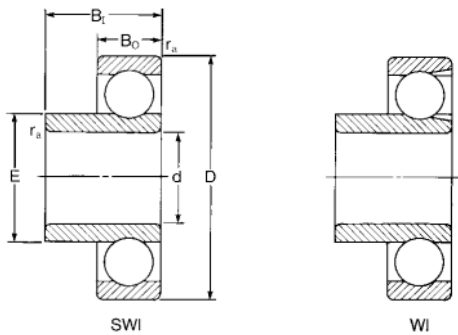

300SWI Non-Filling Notch Type

300WI Filling Notch Type

To determine bearing life, refer to page 54 for SWI, and page 62 for WI.

MRC Bearing Number	Bore d mm in		Outside Diameter D mm in		Width						Basic Radial Load Rating				Speed Rating ²⁾					
					B ₀		B ₁		E		Fillet ¹⁾ Radius r _a		ZD ²⁾		Dynamic C ₃₎		Static C ₀		Grease RPM	Oil RPM
					mm	in	mm	in	mm	in	mm	in	mm	in	N	lbf	N	lbf		
305SWI	25	.9843	62	2.4409	17	.6693	25.4	1	38.1	1.499	1.0	.04	850	1.32	20 800	4 680	11 200	2 520	11 000	14 000
306SWI	30	1.1811	72	2.8346	19	.7480	30.16	1 ^{3/4}	43.1	1.698	1.0	.04	1 290	2.00	29 600	6 650	16 600	3 730	9 000	11 000
307SWI	35	1.3780	80	3.1496	21	.8268	34.93	1 ^{1/2}	48.7	1.917	1.5	.06	1 630	2.53	36 400	8 180	20 800	4 680	8 500	10 000
309SWI	45	1.7717	100	3.9370	25	.9843	39.69	1 ^{1/4}	61.1	2.405	1.5	.06	2 440	3.78	52 700	11 900	31 500	7 080	6 700	8 000
310SWI	50	1.9685	110	4.3307	27	1.0630	44.45	1 ^{3/4}	67.5	2.659	2.0	.08	2 900	4.50	61 800	13 900	38 000	8 540	6 300	7 500
311SWI	55	2.1654	120	4.7244	29	1.1417	49.21	1 ^{13/16}	74.0	2.915	2.0	.08	3 410	5.28	71 500	16 100	45 000	10 100	5 600	6 700
313SWI	65	2.5591	140	5.5118	33	1.2992	58.74	2 ^{5/16}	85.1	3.350	2.0	.08	4 540	7.03	92 300	20 800	60 000	13 500	4 800	5 600
315SWI	75	2.9528	160	6.2992	37	1.4567	68.26	2 ^{11/16}	98.9	3.895	2.0	.08	6 530	10.1	121 000	27 200	85 000	19 100	4 300	5 000
318SWI	90	3.5433	190	7.4803	43	1.6929	73.03	2 ^{7/8}	121	4.750	2.5	.10	7 280	11.3	133 000	29 900	98 000	22 000	3 400	4 000
320SWI	100	3.9370	215	8.4646	47	1.8504	82.55	3 ^{1/4}	132	5.210	2.5	.10	11 600	18.0	182 000	40 900	150 000	33 700	3 000	3 600
308WI	40	1.5748	90	3.5433	23	.9055	36.51	1 ^{7/16}	54.8	2.159	1.5	.06	2 770	4.30	46 800	10 500	36 000	8 090	6 200	7 500
311WI	55	2.1654	120	4.7244	29	1.1417	44.45	1 ^{3/4}	72.7	2.863	2.0	.08	4 690	7.26	74 800	16 800	61 000	13 700	4 600	5 600
312WI	60	2.3622	130	5.1181	31	1.2205	53.98	2 ^{1/8}	79.1	3.114	2.0	.08	5 430	8.42	91 300	20 500	78 000	17 500	4 300	5 300
314WI	70	2.7559	150	5.9055	35	1.3780	63.50	2 ^{1/2}	94.5	3.719	2.0	.08	7 740	12.0	114 000	25 600	102 000	22 900	3 700	4 500
315WI	75	2.9528	160	6.2992	37	1.4567	68.26	2 ^{11/16}	101	3.976	2.0	.08	8 740	13.6	125 000	28 000	116 000	26 000	3 500	4 300
316WI	80	3.1496	170	6.6929	39	1.5354	68.26	2 ^{11/16}	109	4.282	2.0	.08	9 470	14.7	138 000	31 000	129 000	29 000	3 300	4 000
318WI	90	3.5433	190	7.4803	43	1.6929	73.03	2 ^{7/8}	121	4.750	2.5	.10	12 100	18.8	157 000	35 300	160 000	36 000	2 800	3 400

¹⁾ Fillet radius indicates maximum fillet radius on shaft or in housing which bearing corner will clear.

²⁾ Listed values are for pressed steel or polyamide cage, ABEC-1.

The values have been determined through historical application and practice. For a more complete explanation, see page 276.

³⁾ Rating for one million revolutions or 500 hours at 33¹/₃ RPM.

NOTES

Table of Contents

	Page
Duplex Bearings	236
97000 Series	239
ABEC Tolerances.....	241
Shaft and Housing Fits	247
Internal Radial Clearance.....	272
Dynamic and Static Load Ratings	273
Bearing Life	274
Speed Factors.....	275
Speed Ratings.....	276
Minimum Thrust Load for Angular Contact Bearings.....	277
Minimum Radial Load for Double-Row Bearings	279
Materials and Limitations	281
Lubrication.....	285
Vibration Data.....	303
Snap Ring Data.....	325
Locknuts and Lockwashers	329
Locknut Torque and Clamping Force	332
Installation Procedures.....	333
Shaft and Housing Shoulder Diameters	340
Bearing Weights	344
ABMA Identification Code.....	347
Millimeter-Inch Equivalents	350
Fraction-Decimal Equivalents	352
Metric Conversion Factors.....	353
Useful Formulae.....	356
Product Index.....	379

An MRC duplex bearing is specifically manufactured with a controlled relationship between the axial location of the inner and outer ring faces. Duplex bearings are ordinarily supplied as half pairs, but combinations of three or more bearings are also available.

MRC duplex bearings may be used to advantage in applications where:

1. Axial and radial deflections must be held to a minimum;
2. Maximum radial capacity is required;
3. Heavy single direction or reversing thrust loads must be supported;
4. Axial shaft location must be maintained under reversing thrust loads; and
5. Moment loading is present.

Standard Methods of Mounting

Duplex bearings can be mounted in three different ways to suit different loading conditions and requirements for rigidity. The three different positions bear the identification symbols "DB," "DF," and "DT."

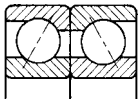

DB—Back-to-back

The sketch above shows the back-to-back (DB) position where the two halves are placed so that the contact angle lines of the two bearings diverge inwardly. For all MRC Duplex bearings, this means that the marked faces of the outer rings are adjacent. 7000 Series and Type R bearings have the low shoulder sides of the outer rings facing outward.

A DB pair may be used to carry: (1) heavy radial loads; (2) combined radial and thrust loads; (3) reversing thrust loads; (4) moment loads. Due to its construction, the DB pair has great angular rigidity and may be used in applications where it is necessary to restrict misalignment or shaft deflection. DB pairs are axially clamped on the shaft but may float in the housing to provide for thermal expansion.

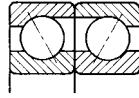

DF—Face-to-face

This sketch shows the face-to-face (DF) position, where the two halves are placed so that the contact angle lines of the two bearings are converging inwardly. For all MRC duplex bearings, this means that the unmarked faces of the outer rings are together. On all angular contact and Type R bearings, the low shoulder sides of the outer rings will be adjacent.

The DF position may be used to advantage where the duplex pair carries: (1) a heavy radial load; (2) a combined radial and thrust load; (3) a reversing thrust load. This method of mounting allows the bearing to take care of a small amount of misalignment. DF pairs are axially clamped in the housing and on the shaft.

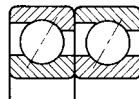

DT—Tandem

This illustration shows the tandem mounting arrangement, where the two halves are placed so that the contact angle lines are parallel. For all MRC duplex bearings, this means that the stamped face of one bearing is in contact with the unstamped face of the other bearing.

The DT mounting is used to carry extremely high thrust loads in one direction where high speeds or space limitations prevent the use of a larger bearing.

Special Methods of Mounting

The three methods of mounting duplex pairs—DB, DF, and DT—are basic. However, other combinations may frequently be used to advantage. A few of these combinations are shown below.

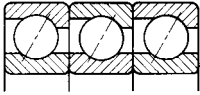

Duplex Stack of Three Bearings (1½ Pair) Mounted in Tandem

This arrangement shows three bearings mounted in the tandem relationship and will provide greater thrust load carrying capacity, since three bearings are sharing the thrust load.

Additional thrust carrying capacity may be obtained by increasing the number of bearings in the stack.

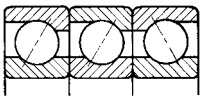

Duplex Arrangement of a DT Pair Mounted in DB Relationship with a Single Bearing

An arrangement such as this will provide extremely high load-carrying capacity in the direction of the heavy outer ring shoulder of the two tandem mounted bearings as well as considerable reversing thrust. If the thrust load in both directions is equal in magnitude and duration, an arrangement of four bearings could be used in which a DT pair would be mounted in DB relationship to another DT pair. The set would have the suffix DTDB.

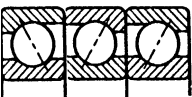

Duplex Arrangement of a DT Mounted in DF Relationship with a Single Bearing

This arrangement provides the same capabilities as the DB mounting except the bearings are mounted in a DF relationship. The set would have the suffix DTDF.

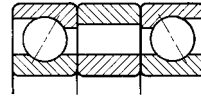

DB Pair Separated by Spacers

It is sometimes desirable to separate duplex bearings by equal length spacers mounted between the two inner rings and the two outer rings. This mounting arrangement is desirable when the pair is subjected to a heavy moment load or when it is necessary to minimize shaft deflection. Care should be taken to make certain that these spacers are parallel and equal in length.

Single Bearings (½ Pair)—DU, DS, DE

MRC bearings with controlled axial relationship of faces are available as single bearings (1/2 pair). They are ordinarily specified when the customer uses duplex bearings in a number of different mounting arrangements and wishes to simplify the problem of stocking prearranged pairs. Single duplex bearings are ground for universal mounting and may be matched with any other bearing from a carton having identical markings.

Type DU bearings have flush ground faces and when mounted in pairs and clamped, have neither preload nor end play.

Type DS bearings are furnished with preload and are also identified on the bearing with the designation DL, DM, DH or DX for light, medium, heavy, or special preload respectively.

Type DE bearings are furnished with end play as clamped and are also identified on the bearing with the designation CA, CB, CC or CX for specific end play values with CX calling for special end play.

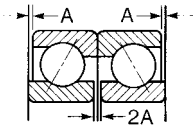

Before Clamping

Preloaded Bearings

Preloaded duplex pairs are made from single bearings having inner and outer rings of equal width but in which the stamped face of the outer ring protrudes beyond the face of the inner. The sketches show this relationship for a DB pair. "A" is known as the bearing offset.

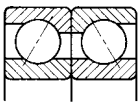

Clamped

When the inner and outer rings are clamped together an elastic deformation takes place in the contact between the balls and races. Since the deflection rate of a bearing decreases with increasing load it is possible to eliminate the major portion of the potential deflection of a bearing under load through preloading.

In order to suit the customers' application requirements MRC bearings are available with light, medium, heavy or special preload. Please consult our Technical Services Department for the proper selection of preload.

End Play

Duplex pairs with end play are made from single bearings having inner and outer rings of equal width but in which the face of the inner protrudes beyond the stamped face of the outer. End play in duplex pairs is desirable where there is misalignment, high operating temperatures or when the bearings are mounted with a heavy press fit on the shaft.

Interchangeability

Types DU, DS and DE (single bearings) may be mounted in the DB, DF, or DT relationship. However, these bearings should not be used with bearings from any other box unless the markings on both boxes are identical.

In the case of making replacements for bearings which have been installed and run, we recommend that both bearings be replaced. This avoids the dangers involved in attempting to match two bearings, one of which has unknown internal characteristics.

Shaft and Housing Fitting Practices

The control of the axial location of inner and outer ring faces found in all duplex bearings is dependent upon the internal clearance in the bearing. A change in internal clearance will result in a change in the flushness or offset of the faces.

In mounting a duplex pair, it is particularly important that excessive press fits on the shaft or in the housing be avoided. Otherwise, the individual bearings in the set will be axially preloaded against each other which might result in excessive heating and early failure. In those cases where heavy press fits are imperative, duplex sets with end play should be used.

Refer to page 248 for mounting recommendations.

Packaging

Types DB, DF, and DT duplex pairs are ordinarily supplied wired together in the same relationship as they are to be used. The pair is then packaged together and the carton is stamped with the appropriate symbol.

Types DU, DS and DE (single bearings) may be packaged separately or two to a box. The customer should state a preference. For packaging information on duplex bearing sets consisting of three or more bearings, please consult MRC's Technical Services Department.

97000U and 97000H Series

The 97000U Series consists of a matched set of 9000UDT and 7000DT flush ground bearings having a 29° contact angle. The 97000H Series consists of a matched set of 9000HDT (split outer ring) and 7000DT flush ground bearings.

97000UP and 97000HP Series

The 97000UP Series consists of a matched set of 9000UPDT and 7000PDT flush ground bearings having a 40° contact angle. The 97000HP Series consist of a matched set of 9000HPDT (split outer ring) and 7000PDT flush ground bearings.

Typical Mountings

The bearings are usually mounted in pairs. This arrangement divides the thrust load in one direction while accommodating reversing thrust load. To increase thrust capacity in one direction it is possible to mount additional bearings in tandem. The number of bearings in the set will be identified by a number at the end of the bearing designation. For example, a set of three bearings (triplex) is identified as the 97000U3 and a set of four (quadruplex) as the 97000U4. Numbers 2 through 9 only will apply. Numbers 10 and higher indicate some special characteristic. Illustration of typical mountings are shown below.

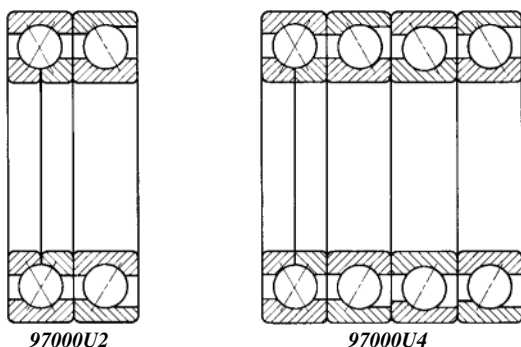

Mounting Orientation

Caution: To obtain proper load distribution, it is necessary to orient mating bearing ring faces, and the inner ring halves of the split ring bearing (9000UDT), according to the illustration below. The counterbored outer ring bearing (7000DT) can be mounted either at side (A) or side (B) of the split ring bearing as shown. In addition, each bearing in the set will be marked with a "V" etched on the outer ring surface with the apex pointing in the main shaft thrust direction.

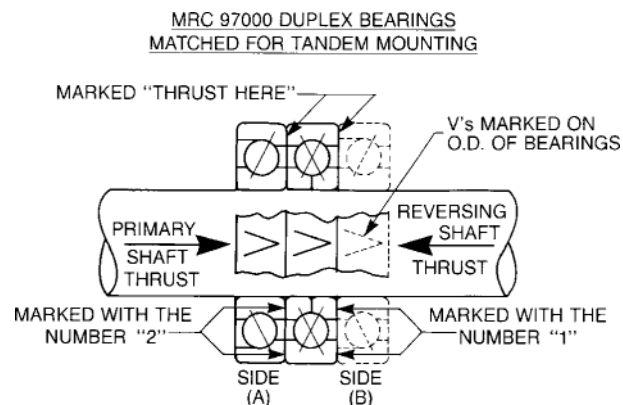

Notes: The numbers "1" and "2" marked on the bearing with the split inner ring, are to keep the proper relationship between the inner rings and the outer ring.

The counterbore bearing(s) can be mounted either side (A) or (B) (above or below) the split bearing provided that the "V"s marked on the O.D. of bearings are pointed in the direction of the "Primary Shaft Thrust".

Bearing Identification Marking

The box and bearings will be marked according to the following example.

Bearing size: 97314UP2

Box: 97314UP2-BRZ

0001

BRZ = Machined Bronze Cage

0001 = MRC Specification Code Suffix

Bearing: All bearings in the set will be marked
97314UP2 0001

Previous marking: The bearing set was identified on the box as 9314UPDT/7314PDT; and on the bearings as 9314UPDT and 7314PDT.

NOTES

Tolerances in inches (shaded) and millimeters.

Inner Ring

Bore Diameter (mm)	Over Incl	2.5 10	10 18	18 30	30 50	50 80	80 120	120 150	150 180	180 250
Bore Diameter	+.0000	-.0003	-.0003	-.0004	-.00045	-.0006	-.0008	-.0010	-.0010	-.0012
		-.008	-.008	-.010	-.012	-.015	-.020	-.025	-.025	-.030
Bore Out-of-Round (Max)	1800, 1900 Series	.0004	.0004	.0005	.0006	.00075	.0010	.0012	.0012	.0015
		.010	.010	.013	.015	.019	.025	.031	.031	.038
	100 Series	.0003	.0003	.0004	.00045	.00075	.0010	.0012	.0012	.0015
		.008	.008	.010	.012	.019	.025	.031	.031	.038
200 300 400 Series	.00025	.00025	.0003	.00035	.00045	.0006	.00075	.00075	.0009	
	.006	.006	.008	.009	.011	.015	.019	.019	.023	
Radial Runout (Max)		.0004	.0004	.0005	.0006	.0008	.0010	.0012	.0012	.0016
		.010	.010	.013	.015	.020	.025	.030	.030	.040
Width Variation (Max)		.0006	.0008	.0008	.0008	.0010	.0010	.0012	.0012	.0012
		.015	.020	.020	.020	.025	.025	.030	.030	.030
Side Runout With Bore (Max)		.0008	.0008	.0008	.0008	.0010	.0010	.0012	.0012	.0012
		.020	.020	.020	.020	.025	.025	.030	.030	.030
Raceway Runout With Side (Max)		.0008	.0008	.0008	.0008	.0010	.0010	.0012	.0012	.0016
		.020	.020	.020	.020	.025	.025	.030	.030	.040
Ring Width Single Bearing	+.0000	-.0047	-.0047	-.0047	-.0047	-.0059	-.0079	-.0098	-.0098	-.0118
		-.120	-.120	-.120	-.120	-.150	-.200	-.250	-.250	-.300
Ring Width Duplex Bearing	+.0000	-.0098	-.0098	-.0098	-.0098	-.0150	-.0150	-.0197	-.0197	-.0197
		-.250	-.250	-.250	-.250	-.380	-.380	-.500	-.500	-.500

Outer Ring

Outside Diameter (mm)	Over Incl	6 18	18 30	30 50	50 80	80 120	120 150	150 180	180 250	250 315	315 400
Outside Diameter	+.0000	-.0003	-.00035	-.00045	-.0005	-.0006	-.0007	-.0010	-.0012	-.0014	-.0016
		-.008	-.009	-.011	-.013	-.015	-.018	-.025	-.030	-.035	-.040
Outside Diameter Out-of-Round (Max)	1800, 1900 Series	.0004	.00045	.00055	.00065	.00075	.0009	.0012	.0015	.0017	.0020
		.010	.012	.014	.016	.019	.023	.031	.038	.044	.050
	100 Series	.0003	.00035	.00045	.0005	.00075	.0009	.0012	.0015	.0017	.0020
		.008	.009	.011	.013	.019	.023	.031	.038	.044	.050
200 300 400 Series	.00025	.0003	.0003	.0004	.00045	.00055	.00075	.0009	.0010	.0012	
	.006	.007	.008	.010	.011	.014	.019	.023	.026	.030	
100, 200, 300, 400 Series Shielded* and Sealed	.0004	.00045	.00065	.0008	.0010	.0012	.0015	—	—	—	
	.010	.012	.016	.020	.026	.030	.038	—	—	—	
Radial Runout (Max)		.0006	.0006	.0008	.0010	.0014	.0016	.0018	.0020	.0024	.0028
		.015	.015	.020	.025	.035	.040	.045	.050	.060	.070
Width Variation (Max)		Identical to Inner Ring of Same Bearing									
O.D. Runout With Side (Max)		.0008	.0008	.0008	.0010	.0010	.0012	.0012	.0012	.0014	.0016
		.020	.020	.020	.025	.025	.030	.030	.030	.035	.040
Raceway Runout With Side (Max)		.0012	.0012	.0012	.0012	.0014	.0016	.0020	.0024	.0028	.0031
		.030	.030	.030	.030	.035	.040	.050	.060	.070	.080
Ring Width Single Bearing		Identical to Inner Ring of Same Bearing									
Ring Width Duplex Bearing		Identical to Inner Ring of Same Bearing									

*No values established for 1800 and 1900 series.

**ABEC 3 ABMA/ISO Tolerances for Single-Row,
Double-Row, and Duplex Bearings**

MRC Bearing Services

Tolerances in inches (shaded) and millimeters.

Inner Ring

Bore Diameter (mm)	Over Incl	2.5 10	10 18	18 30	30 50	50 80	80 120	120 150	150 180	180 250
Bore Diameter	+ .0000	-.0003	-.0003	-.0003	-.00045	-.0005	-.0006	-.0007	-.0007	-.00085
		-.007	-.007	-.008	-.010	-.012	-.015	-.018	-.018	-.022
Bore Out-of-Round (Max)	1800, 1900 Series	.00035	.00035	.0004	.0005	.0006	.00075	.0009	.0009	.0011
		.009	.009	.010	.013	.015	.019	.023	.023	.028
	100 Series	.0003	.0003	.0003	.0004	.0006	.00075	.0009	.0009	.0011
		.007	.007	.008	.010	.015	.019	.023	.023	.028
	200 300 400 Series	.0002	.0002	.00025	.0003	.00035	.00045	.00055	.00055	.00065
		.005	.005	.006	.008	.009	.011	.014	.014	.017
Radial Runout (Max)		.00025	.0003	.0003	.0004	.0004	.0005	.0007	.0007	.0008
		.006	.007	.008	.010	.010	.013	.018	.018	.020
Width Variation (Max)		.0006	.0008	.0008	.0008	.0010	.0010	.0012	.0012	.0012
		.015	.020	.020	.020	.025	.025	.030	.030	.030
Side Runout With Bore (Max)		.0004	.0004	.0004	.0004	.0005	.0005	.0006	.0006	.0006
		.010	.010	.010	.010	.013	.013	.015	.015	.015
Raceway Runout With Side (Max)		.0006	.0006	.0006	.0006	.0007	.0007	.0009	.0009	.0009
		.015	.015	.015	.015	.018	.018	.023	.023	.023
Ring Width Single Bearing	+ .0000	-.0047	-.0047	-.0047	-.0047	-.0059	-.0079	-.0098	-.0098	-.0118
		-.120	-.120	-.120	-.120	-.150	-.200	-.250	-.250	-.300
Ring Width Duplex Bearing	+ .0000	-.0098	-.0098	-.0098	-.0098	-.0150	-.0150	-.0197	-.0197	-.0197
		-.250	-.250	-.250	-.250	-.380	-.380	-.500	-.500	-.500

Outer Ring

Outside Diameter (mm)	Over Incl	6 18	18 30	30 50	50 80	80 120	120 150	150 180	180 250	250 315	315 400
Outside Diameter	+ .0000	-.0003	-.0003	-.0004	-.0004	-.0005	-.0006	-.0007	-.0008	-.0010	-.0011
		-.007	-.008	-.009	-.011	-.013	-.015	-.018	-.020	-.025	-.028
Outside Diameter Out-of-Round (Max)	1800, 1900 Series	.0004	.0004	.0004	.0006	.0006	.0007	.0009	.0010	.0012	.0014
		.009	.010	.011	.014	.016	.019	.023	.025	.031	.035
	100 Series	.0003	.0003	.0004	.0004	.0006	.0007	.0009	.0010	.0012	.0014
		.007	.008	.009	.011	.016	.019	.023	.025	.031	.035
	200 300 400 Series	.0002	.0002	.0003	.0003	.0004	.0004	.0006	.0006	.0007	.0008
		.005	.006	.007	.008	.010	.011	.014	.015	.019	.021
	100, 200, 300, 400 Series Shielded* and Sealed	.0004	.0004	.0005	.0006	.0008	.0010	.0012	—	—	—
		.009	.010	.013	.016	.020	.025	.030	—	—	—
Radial Runout (Max)		.0003	.0004	.0004	.0005	.0007	.0008	.0009	.0010	.0012	.0014
		.008	.009	.010	.013	.018	.020	.023	.025	.030	.035
Width Variation (Max)		Identical to Inner Ring of Same Bearing									
O.D. Runout With Side (Max)		.0004	.0004	.0004	.0005	.0005	.0006	.0006	.0006	.0007	.0008
		.010	.010	.010	.013	.013	.015	.015	.015	.018	.020
Raceway Runout With Side (Max)		.0008	.0008	.0008	.0008	.0009	.0010	.0012	.0014	.0016	.0018
		.020	.020	.020	.020	.023	.025	.030	.035	.040	.045
Ring Width Single Bearing		Identical to Inner Ring of Same Bearing									
Ring Width Duplex Bearing		Identical to Inner Ring of Same Bearing									

*No values established for 1800 and 1900 series.

Tolerances in inches (shaded) and millimeters.

Inner Ring

Bore Diameter (mm)	Over Incl	2.5 10	10 18	18 30	30 50	50 80	80 120	120 150	150 180	180 250
Bore Diameter	+ .0000	-.0002	-.0002	-.00025	-.0003	-.00035	-.0004	-.0005	-.0005	-.0006
		-.005	-.005	-.006	-.008	-.009	-.010	-.013	-.013	-.015
Bore Out-of-Round (Max)	1800, 1900 Series	.0002	.0002	.00025	.0003	.00035	.0004	.0005	.0005	.0006
		.005	.005	.006	.008	.009	.010	.013	.013	.015
	100, 200, 300 400 Series	.00015	.00015	.0002	.00025	.0003	.0003	.0004	.0004	.00045
		.004	.004	.005	.006	.007	.008	.010	.010	.012
Radial Runout (Max)		.00015	.00015	.00015	.0002	.0002	.00025	.0003	.0003	.0004
		.004	.004	.004	.005	.005	.006	.008	.008	.010
Width Variation (Max)		.0002	.0002	.0002	.0002	.00025	.0003	.0003	.0003	.0004
		.005	.005	.005	.005	.006	.007	.008	.008	.010
Side Runout With Bore (Max)		.0003	.0003	.0003	.0003	.0003	.00035	.0004	.0004	.00045
		.007	.007	.008	.008	.008	.009	.010	.010	.011
Raceway Runout With Side (Max)		.0003	.0003	.0003	.0003	.0003	.00035	.0004	.0004	.0005
		.007	.007	.008	.008	.008	.009	.010	.010	.013
Ring Width Single Bearing	+ .0000	-.0016	-.0031	-.0047	-.0047	-.0059	-.0079	-.0098	-.0098	-.0118
		-.040	-.080	-.120	-.120	-.150	-.200	-.250	-.250	-.300
Ring Width Duplex Bearing	+ .0000	-.0098	-.0098	-.0098	-.0098	-.0098	-.0150	-.0150	-.0150	-.0197
		-.250	-.250	-.250	-.250	-.250	-.380	-.380	-.380	-.500

Outer Ring

Outside Diameter (mm)	Over Incl	6 18	18 30	30 50	50 80	80 120	120 150	150 180	180 250	250 315	315 400
Outside Diameter	+ .0000	-.0002	-.00025	-.0003	-.00035	-.0004	-.00045	-.0005	-.0006	-.0007	-.0008
		-.005	-.006	-.007	-.009	-.010	-.011	-.013	-.015	-.018	-.020
Outside Diameter Out-of-Round (Max)	1800, 1900 Series	.0002	.00025	.0003	.00035	.0004	.00045	.0005	.0006	.0007	.0008
		.005	.006	.007	.009	.010	.011	.013	.015	.018	.020
	100, 200, 300 400 Series	.00015	.0002	.0002	.0003	.0003	.0003	.0004	.00045	.00055	.0006
		.004	.005	.005	.007	.008	.008	.010	.011	.014	.015
Radial Runout (Max)		.0002	.00025	.0003	.0003	.0004	.00045	.0005	.0006	.0007	.0008
		.005	.006	.007	.008	.010	.011	.013	.015	.018	.020
Width Variation (Max)		Identical to Inner Ring of Same Bearing									
O.D. Runout With Side (Max)		.0003	.0003	.0003	.0003	.00035	.0004	.0004	.00045	.0005	.0005
		.008	.008	.008	.008	.009	.010	.010	.011	.013	.013
Raceway Runout With Side (Max)		.0003	.0003	.0003	.0004	.00045	.0005	.00055	.0006	.0007	.0008
		.008	.008	.008	.010	.011	.013	.014	.015	.018	.020
Ring Width Single Bearing		Identical to Inner Ring of Same Bearing									
Ring Width Duplex Bearing		Identical to Inner Ring of Same Bearing									

**ABEC 7 ABMA/ISO Tolerances for Single-Row,
Double-Row, and Duplex Bearings**

MRC Bearing Services

Tolerances in inches (shaded) and millimeters.

Inner Ring

Bore Diameter (mm)	Over Incl	2.5 10	10 18	18 30	30 50	50 80	80 120	120 150	150 180	180 250
Bore Diameter	+ .0000	-.00015	-.00015	-.0002	-.00025	-.0003	-.0003	-.0004	-.0004	-.00045
		-.004	-.004	-.005	-.006	-.007	-.008	-.010	-.010	-.012
Bore Out-of-Round (Max)	1800, 1900 Series	.0015	.00015	.0002	.00025	.0003	.0003	.0004	.0004	.00045
		.004	.004	.005	.006	.007	.008	.010	.010	.012
	100, 200, 300 400 Series	.0001	.0001	.00015	.0002	.0002	.00025	.0003	.0003	.00035
		.003	.003	.004	.005	.005	.006	.008	.008	.009
Radial Runout (Max)		.0001	.0001	.0001	.00015	.00015	.0002	.00025	.00025	.0003
		.0025	.0025	.003	.004	.004	.005	.006	.006	.008
Width Variation (Max)		.0001	.0001	.0001	.0001	.00015	.00015	.0002	.0002	.00025
		.0025	.0025	.0025	.003	.004	.004	.005	.005	.006
Side Runout With Bore (Max)		.0001	.0001	.00015	.00015	.0002	.0002	.00025	.00025	.0003
		.003	.003	.004	.004	.005	.005	.006	.006	.007
Raceway Runout With Side (Max)		.0001	.0001	.00015	.00015	.0002	.0002	.0003	.0003	.0003
		.003	.003	.004	.004	.005	.005	.007	.007	.008
Ring Width Single Bearing	+ .0000	-.0016	-.0031	-.0047	-.0047	-.0059	-.0079	-.0098	-.0098	-.0118
		-.040	-.080	-.120	-.120	-.150	-.200	-.250	-.250	-.300
Ring Width Duplex Bearing	+ .0000	-.0098	-.0098	-.008	-.0098	-.0098	-.0150	-.0150	-.0150	-.0197
		-.250	-.250	-.250	-.250	-.250	-.380	-.380	-.380	-.500

Outer Ring

Outside Diameter (mm)	Over Incl	6 18	18 30	30 50	50 80	80 120	120 150	150 180	180 250	250 315	315 400
Outside Diameter	+ .0000	-.00015	-.0002	-.00025	-.0003	-.0003	-.00035	-.0004	-.00045	-.0005	-.0006
		-.004	-.005	-.006	-.007	-.008	-.009	-.010	-.011	-.013	-.015
Outside Diameter Out-of-Round (Max)	1800, 1900 Series	.00015	.0002	.00025	.0003	.0003	.00035	.0004	.00045	.0005	.0006
		.004	.005	.006	.007	.008	.009	.010	.011	.013	.015
	100, 200, 300 400 Series	.0001	.00015	.0002	.0002	.00025	.0003	.0003	.0003	.0004	.00045
		.003	.004	.005	.005	.006	.007	.008	.008	.010	.011
Radial Runout (Max)		.0001	.00015	.0002	.0002	.00025	.0003	.0003	.0004	.00045	.0005
		.003	.004	.005	.005	.006	.007	.008	.010	.011	.013
Width Variation (Max)		Identical to Inner Ring of Same Bearing									
O.D. Runout With Side (Max)		.00015	.00015	.00015	.00015	.0002	.0002	.0002	.0003	.0003	.0004
		.004	.004	.004	.004	.005	.005	.005	.007	.008	.010
Raceway Runout With Side (Max)		.0002	.0002	.0002	.0002	.00025	.0003	.0003	.0004	.0004	.0005
		.005	.005	.005	.005	.006	.007	.008	.010	.010	.013
Ring Width Single Bearing		Identical to Inner Ring of Same Bearing									
Ring Width Duplex Bearing		Identical to Inner Ring of Same Bearing									

Tolerances in inches (shaded) and millimeters.

Inner Ring

Bore Diameter (mm)	Over Incl	2.5 10	10 18	18 30	30 50	50 80	80 120	120 150	150 180	180 250
Bore Diameter	+ .0000	-.0001 -.0025	-.0001 -.0025	-.0001 -.0025	-.0001 -.0025	-.00015 -.004	-.0002 -.005	-.0003 -.007	-.0003 -.007	-.0003 -.008
Bore Out-of-Round (Max)		.0001 .0025	.0001 .0025	.0001 .0025	.0001 .0025	.0015 .004	.0002 .005	.0003 .007	.0003 .007	.0003 .008
Radial Runout (Max)		.00005 .0015	.00005 .0015	.0001 .0025	.0001 .0025	.0001 .0025	.0001 .0025	.0001 .0025	.0002 .005	.0002 .005
Width Variation (Max)		.00005 .0015	.00005 .0015	.00005 .0015	.00005 .0015	.00005 .0015	.0001 .0025	.0001 .0025	.00015 .004	.0002 .005
Side Runout With Bore (Max)		.00005 .0015	.00005 .0015	.00005 .0015	.00005 .0015	.00005 .0015	.0001 .0025	.0001 .0025	.00015 .004	.0002 .005
Raceway Runout With Side (Max)		.00005 .0015	.00005 .0015	.0001 .0025	.0001 .0025	.0001 .0025	.0001 .0025	.0001 .0025	.0002 .005	.0002 .005
Ring Width Single Bearing	+ .0000	-.0016 -.040	-.0031 -.080	-.0047 -.120	-.0047 -.120	-.0059 -.150	-.0079 -.200	-.0098 -.250	-.0118 -.300	-.0138 -.350
Ring Width Duplex Bearing	+ .0000	-.0098 -.250	-.0098 -.250	-.0098 -.250	-.0098 -.250	-.0098 -.250	-.0150 -.380	-.0150 -.380	-.0197 -.500	-.0197 -.500

Outer Ring

Outside Diameter (mm)	Over Incl	6 18	18 30	30 50	50 80	80 120	120 150	150 180	180 250	250 315	315 400
Outside Diameter	+ .0000	-.0001 -.0025	-.00015 -.004	-.00015 -.004	-.00015 -.004	-.0002 -.005	-.0002 -.005	-.0003 -.007	-.0003 -.008	-.0003 -.008	-.0004 -.010
Outside Diameter Out-of-Round (Max)		.0001 .0025	.00015 .004	.00015 .004	.00015 .004	.0002 .005	.0002 .005	.0003 .007	.0003 .008	.0003 .008	.0004 .010
Radial Runout (Max)		.00005 .0015	.0001 .0025	.0001 .0025	.00015 .004	.0002 .005	.0002 .005	.0002 .005	.0003 .007	.0003 .007	.0005 .008
Width Variation (Max)		Identical to Inner Ring of Same Bearing									
O.D. Runout With Side (Max)		.00005 .0015	.00005 .0015	.00005 .0015	.00005 .0015	.0001 .0025	.0001 .0025	.0001 .0025	.00015 .004	.0002 .005	.0003 .007
Raceway Runout With Side (Max)		.00005 .0015	.0001 .0025	.0001 .0025	.00015 .004	.0002 .005	.0002 .005	.0002 .005	.0003 .007	.0003 .007	.0003 .008
Ring Width Single Bearing		Identical to Inner Ring of Same Bearing									
Ring Width Duplex Bearing		Identical to Inner Ring of Same Bearing									

NOTES

Table of Contents

	Page
Radial Location of Bearings	248
General Recommendations for Single, Duplex and Tapered Bore Bearings	250
Fits for Hollow Shafts	250
General Recommended Shaft Limit Tables
ABEC-1	252
ABEC-3	256
ABEC-5	260
ABEC-7	262
General Recommended Housing Limit Tables
ABEC-1	254
ABEC-3	258
ABEC-5	261
ABEC-7	263
Special Shaft and Housing Fits	264
ISO Fits for Solid Steel Shafts	265
ISO Shaft Limit Tables	266
ISO Fits for Cast Iron and Steel Housings	268
ISO Housing Limit Tables	269

Radial Location of Bearings

If the load carrying ability of a bearing is to be fully utilized, its rings or washers must be supported around their complete circumference and across the whole width of the raceway. The support must be firm and even and, for inner rings, can be provided by a cylindrical or tapered seating or, for washers, by a flat (plane) support surface. This means that the seatings must be made with adequate accuracy and that they have a surface which is uninterrupted by grooves, holes or other features. In addition the rings must be reliably secured to prevent them from turning on or in their seatings under load. Inadequately or incorrectly secured bearing rings generally produce damage to the bearings and associated components.

A satisfactory radial location and an adequate support can generally only be obtained when the rings are mounted with an appropriate degree of interference. However, when simple mounting and dismounting are desirable, or when axial displacement is required with a non-locating bearing, interference fits cannot be used.

Selection of fit

When selecting a fit, the factors discussed in the following and the general guidelines in respect of them should be considered.

1. Conditions of rotation

Conditions of rotation refer to the movement of the bearing ring being considered in relation to the direction of the load. Essentially there are three different conditions: "rotating load" "stationary load" and "direction of load indeterminate".

If the bearing ring rotates and the load is stationary, or if the ring is stationary and the load rotates so that all points on the raceway are subjected to load in the course of one revolution, the load is defined as a "rotating load". Heavy loads which do not rotate but oscillate (for example, those acting on the outer rings of connecting rod bearings) are generally considered as rotating loads.

"Stationary load" applies if the bearing ring is stationary and the load is also stationary, or if the ring and load rotate at the same speed so that the load is always directed to the same point on the raceway.

Variable external loads, shock loads, vibrations and unbalance loads in high-speed machines give rise to changes in the direction of load which cannot be accurately described. Such conditions are classified as "direction of load indeterminate".

A bearing ring subjected to a rotating load will turn (creep) on its own seating if mounted with a clearance fit, and wear (fretting corrosion) of the contacting

surfaces will occur. To prevent this, interference fits must be used. The degree of interference needed is dictated by the operating conditions (see points 2 and 4).

When a stationary load exists, a bearing ring will not normally turn on its seating. Therefore, the ring need not necessarily have an interference fit unless this is required for other reasons.

When the direction of load is indeterminate and particularly where heavy loads are involved, it is desirable that both rings have an interference fit. For the inner ring the fit recommended for rotating load is normally used. However, when the outer ring must be free to move axially in the housing and the load is not heavy, a somewhat looser fit than that recommended for rotating load may be used.

2. Magnitude of the load.

The interference fit of a bearing inner ring on its seating will be loosened with increasing load as the ring will expand. Under the influence of rotating load the ring may begin to creep. The degree of interference must therefore be related to the magnitude of the load: the heavier the load, particularly if it is of shock character, the greater the interference required.

3. Bearing internal clearance

An interference fit of a bearing on the shaft or in the housing means that the ring is elastically deformed (expanded or compressed) and the bearing internal clearance reduced. A certain minimum clearance should remain, however (see also "Bearing radial clearance", page 272). The initial clearance and permissible reduction depend on the type and size of the bearing. The reduction in clearance due to the interference fit can be so large that bearings with increased radial clearance have to be used in order to prevent the bearing from becoming preloaded.

4. Temperature conditions

In service, bearing rings normally reach a temperature which is higher than that of the components to which they are fitted. This can result in an easing of the fit of the inner ring on its seating, while outer ring expansion may prevent the desired axial displacement of the ring in its housing. Temperature differentials and the direction of heat flow must therefore be carefully considered.

5. Running accuracy requirements

To reduce resilience and vibration, clearance fits should generally not be used for bearings where high demands are placed on running accuracy. Bearing seatings on the shaft and in the housing should be

Radial Location of Bearings (continued)

made to narrow dimensional tolerances, corresponding at least to ABEC-5 for the shaft and ABEC-3 for the housing as shown in the tables.

6. Design and material of shaft and housing

CAUTION: The fit of a bearing ring on its seating must not lead to uneven distortion of the ring (out-of-round). This can be caused for example by discontinuities in the seating surface. Split housings are therefore not generally suitable where outer rings are to have an interference fit.

To ensure adequate support for bearing rings mounted in thin-walled housings, light alloy housings or on hollow shafts, heavier interference fits than those normally selected for thick-walled steel or cast iron housings or for solid shafts should be used (see also "Fits for hollow shafts", page 250).

For stainless steel shafts, reduced shaft interference or increased bearing internal clearance should be considered because of the high coefficient of expansion of stainless steel.

7. Ease of mounting and dismounting

Bearings with clearance fits are usually easier to mount or dismount than those with interference fits. Where operating conditions necessitate interference fits and it is essential that mounting and dismounting can be done easily, separable bearings, or bearings with tapered bore and adapter or withdrawal sleeve may be used.

8. Displacement of non-locating bearing

If non-separable bearings are used as non-locating bearings it is imperative that one of the bearing rings is free to move axially at all times during operation. This is ensured by adopting a clearance fit for that ring which carries a stationary load. When the outer ring is under stationary load so that axial displacement has to take place in the housing bore, a hardened intermediate bushing is often fitted to the outer ring, for example, where light alloy housings are employed. In this way a "hammering out" of the housing seating because of the lower material hardness is avoided; it would otherwise result in the axial displacement being restricted or even impossible after a time. If cylindrical or needle roller bearings having one ring without flanges are used, both bearing rings may be mounted with an interference fit because axial displacement will take place within the bearing.

Recommended Fits

The general recommendation for shaft and housing diameters and resulting fits are shown in the tables on pages 252-263, for ABEC-1, 3, 5, and 7 tolerance grades and either rotating or stationary shaft or housing. They apply to single-row, double-row and duplex bearings mounted on steel shafts and in steel or cast iron housings. For special bearing applications and arrangements, other fits may be required as shown in the tables on pages 264-271.

Duplex Bearings

MRC 7000 PJ Series, 40° contact angle, duplex bearings are supplied with axial looseness, or end play, and should be mounted on the shaft with an ISO k5 fit and in the housing with an ISO H6 fit as shown in the tables. These bearings are identified with the suffix letters “DE” and separately by the letters “CA,” “CB,” “CC” or “CX” and a four-digit MRC specification number. The letters signify specific end play values with “CX” designating special end play. 7000 PJDE bearings are normally stocked with a “CB” end play. The amount of end play per set is shown in the table below.

Bore Diameter (mm)		End Play Per Set			
		Min.		Max.	
Over	Incl	.001 mm	.0001 inch	.001 mm	.0001 inch
—	10	14	6	22	9
10	18	15	6	23	9
18	30	18	7	26	10
30	50	22	9	30	12
50	80	26	10	38	15
80	120	32	13	44	17
120	180	35	14	47	19
180	250	45	18	61	24
250	315	52	21	68	27

Duplex Bearings may also be supplied without end play or preload (free running, no end play) designated on the bearing by the letters “DU”. Bearings with preload are identified on the bearing by the letters “DS” and separately by the letters “DL”, “DM”, “DH” or “DX” and a four digit MRC Specification Code, signifying light, medium, heavy or special preload respectively. These bearings should be mounted on the shaft with an ISO h5 fit and in the housing with an ISO H6 fit. The reduced shaft interference resulting from the ISO h5 fit minimizes the loss of internal clearance caused by expansion of the inner ring. Loss of internal clearance changes the offset, or flushness, of the bearing faces and, in turn, increases bearing preload, which may lead to excessive heating and premature failure. For shaft and housing diameters corresponding to ISO h5 and ISO H6 fits, see pages 266 & 269.

The recommendations described above for general bearing applications are valid for solid steel shafts and cast iron or steel housings. Years of practical experience have shown the recommendations to be correct for a wide range of applications and bearing arrangements.

Tapered Bore Bearings

Bearings with tapered bores are mounted either on tapered shafts or on slotted sleeves having an external taper and mounted on cylindrical shafts. In these cases, the fit of the inner ring is not determined by the selected shaft tolerance but by the distance through which the ring is driven up on the tapered shaft or sleeve. Special precautions with respect to reduction in internal clearance must be observed. For the recommended mounting procedure refer to pages 172 & 173 in the self-aligning ball bearing section.

Fits For Hollow Shafts

If bearings are to be mounted with an interference fit on a hollow shaft it is generally necessary to use a heavier interference fit than that used for a solid shaft in order to achieve the same surface pressure between the inner ring and shaft seating. The following diameter ratios are important when deciding on the fit to be used:

$$c_i = \frac{d_i}{d} \text{ and } c_e = \frac{d}{d_e}$$

where

- c_i = diameter ratio of hollow shaft
- c_e = diameter ratio of inner ring
- d = outside diameter of hollow shaft (= bore diameter of bearing)
- d_i = internal diameter of hollow shaft
- d_e = mean outside diameter of inner ring

The fit is not appreciably affected until the diameter ratio of the hollow shaft $c_i \geq 0.5$. If the outside diameter of the inner ring is not known, the diameter ratio c_e can be calculated with sufficient accuracy from the equation

$$c_e = \frac{d}{k(D - d) + d}$$

where

- d = bore diameter of bearing
- D = outside diameter of bearing
- k = a factor for the bearing type
- $k = 0.25$ for self-aligning ball bearings of series 22 and 23 and for cylindrical roller bearings
- $k = 0.3$ for all other bearings

To determine the requisite interference fit for a bearing to be mounted on a hollow shaft, use is made of the mean probable interference between shaft diameter and bearing bore obtained for the tolerance recommended for a solid shaft of the same diameter. If the plastic deformation (smoothing) of the mating surfaces produced during mounting is neglected, then the effective interference can be equated to the mean probable interference.

The interference Δ_H needed for a hollow shaft of steel can then be determined in relation to the known interference Δ_V for the solid shaft from the diagram below. Δ_V equals the mean value of the smallest and largest values of the probable interference given in the tables. The tolerance for the hollow shaft is then selected so that the mean probable interference is as close as possible to the interference Δ_V obtained from the diagram.

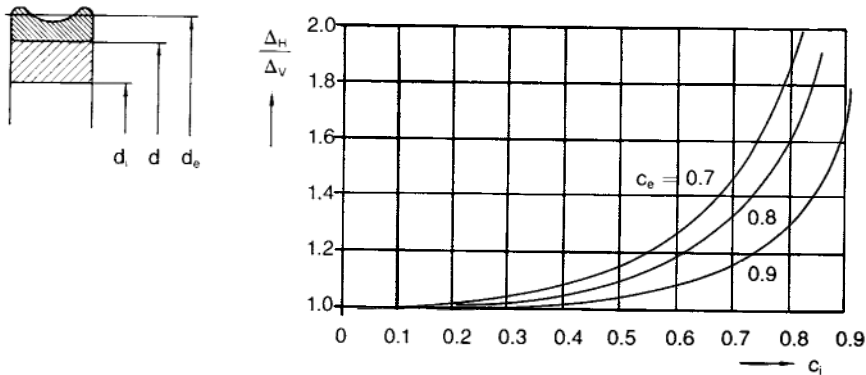

Example:

A 208S deep groove ball bearing is to be mounted on a hollow shaft having a diameter ratio of $C_i = 0.8$. The recommended mean probable interference for a solid steel shaft is 0.00055 determined from the tables for an ABEC-1 grade bearing with a 40mm bore diameter.

$$\text{For } C_i = 0.8 \text{ and } C_e = \frac{40}{0.3(80 - 40) + 40} = 0.77,$$

The ratio $\frac{\Delta_H}{\Delta_V} = 1.7$ from the diagram.

Thus the required interference for the hollow shaft is,
 $\Delta_H = 1.7 \times .00055 = .0009$.

Shaft And Housing Surface Finish

For ABEC-1 bearings, finishes should not exceed 32 AA for shafts up to 2 inches in diameter and 63 AA maximum over 2 inches. Housing bores should not exceed 125 AA.

General Recommended Shaft Limits for Metric Bearings—ISO k5 and g6

Bearing Bore Diameter				Shaft Rotating						Shaft Stationary						
mm	Max		Min		Shaft Diameter (k5)				Fit		Shaft Diameter (g6)				Fit	
	mm	in	mm	in	Max		Min		.001 mm	.0001 in	Max		Min		.001 mm	.0001 in
					mm	in	mm	in			mm	in	mm	in		
4	4	0.1575	3.992	0.1572	4.006	0.1577	4.001	0.1575			3.996	0.1573	3.988	0.1570		
5	5	0.1969	4.992	0.1966	5.006	0.1971	5.001	0.1969	1T	0	4.996	0.1967	4.988	0.1964	12L	5L
6	6	0.2362	5.992	0.2359	6.006	0.2364	6.001	0.2362	14T	5T	5.996	0.2360	5.988	0.2357	4T	1T
7	7	0.2756	6.992	0.2753	7.007	0.2759	7.001	0.2756			6.995	0.2754	6.986	0.2750		
8	8	0.3150	7.992	0.3147	8.007	0.3153	8.001	0.3150	1T	0	7.995	0.3148	7.986	0.3144	14L	6L
9	9	0.3543	8.992	0.3540	9.007	0.3546	9.001	0.3543	15T	6T	8.995	0.3541	8.986	0.3537	3T	1T
10	10	0.3937	9.992	0.3934	10.007	0.3940	10.001	0.3937			9.995	0.3935	9.986	0.3931		
12	12	0.4724	11.992	0.4721	12.009	0.4728	12.001	0.4724			11.994	0.4722	11.983	0.4717		
15	15	0.5906	14.992	0.5903	15.009	0.5910	15.001	0.5906	1T	0	14.994	0.5904	14.983	0.5899	17L	7L
17	17	0.6693	16.992	0.6690	17.009	0.6697	17.001	0.6693	17T	7T	16.994	0.6691	16.983	0.6686	2T	1T
20	20	0.7874	19.990	0.7870	20.011	0.7878	20.002	0.7875			19.993	0.7871	19.980	0.7866		
25	25	0.9843	24.990	0.9839	25.011	0.9847	25.002	0.9844	2T	1T	24.993	0.9840	24.980	0.9835	20L	8L
30	30	1.1811	29.990	1.1807	30.011	1.1815	30.002	1.1812	21T	8T	29.993	1.1808	29.980	1.1803	3T	1T
35	35	1.3780	34.987	1.3775	35.013	1.3785	35.002	1.3781			34.991	1.3776	34.975	1.3770		
40	40	1.5748	39.987	1.5743	40.013	1.5753	40.002	1.5749	2T	1T	39.991	1.5744	39.975	1.5738	25L	10L
45	45	1.7717	44.987	1.7712	45.013	1.7722	45.002	1.7718	26T	10T	44.991	1.7713	44.975	1.7707	4T	1T
50	50	1.9685	49.987	1.9680	50.013	1.9690	50.002	1.9686			49.991	1.9681	49.975	1.9675		
55	55	2.1654	54.985	2.1648	55.015	2.1660	55.002	2.1655			54.990	2.1650	54.971	2.1643		
60	60	2.3622	59.985	2.3616	60.015	2.3628	60.002	2.3623			59.990	2.3618	59.971	2.3611		
65	65	2.5591	64.985	2.5585	65.015	2.5597	65.002	2.5592	2T	1T	64.990	2.5587	64.971	2.5580	29L	11L
70	70	2.7559	69.985	2.7553	70.015	2.7565	70.002	2.7560	30T	12T	69.990	2.7555	69.971	2.7548	5T	2T
75	75	2.9528	74.985	2.9522	75.015	2.9534	75.002	2.9529			74.990	2.9524	74.971	2.9517		
80	80	3.1496	79.985	3.1490	80.015	3.1502	80.002	3.1497			79.990	3.1492	79.971	3.1485		
85	85	3.3465	84.980	3.3457	85.018	3.3472	85.003	3.3466			84.988	3.3460	84.966	3.3452		
90	90	3.5433	89.980	3.5425	90.018	3.5440	90.003	3.5434			89.988	3.5428	89.966	3.5420		
95	95	3.7402	94.980	3.7394	95.018	3.7409	95.003	3.7403	3T	1T	94.988	3.7397	94.966	3.7389	34L	13L
100	100	3.9370	99.980	3.9362	100.018	3.9377	100.003	3.9371	38T	15T	99.988	3.9365	99.966	3.9357	8T	3T
105	105	4.1339	104.980	4.1331	105.018	4.1346	105.003	4.1340			104.988	4.1334	104.966	4.1326		
110	110	4.3307	109.980	4.3299	110.018	4.3314	110.003	4.3308			109.988	4.3302	109.966	4.3294		
115	115	4.5276	114.980	4.5268	115.018	4.5283	115.003	4.5277			114.988	4.5271	114.966	4.5263		
120	120	4.7244	119.980	4.7236	120.018	4.7251	120.003	4.7245			119.988	4.7239	119.966	4.7231		
125	125	4.9213	124.975	4.9203	125.021	4.9221	125.003	4.9214			124.986	4.9207	124.961	4.9198		
130	130	5.1181	129.975	5.1171	130.021	5.1189	130.003	5.1182			129.986	5.1175	129.961	5.1166		
140	140	5.5118	139.975	5.5108	140.021	5.5126	140.003	5.5119	3T	1T	139.986	5.5112	139.961	5.5103	39L	15L
150	150	5.9055	149.975	5.9045	150.021	5.9063	150.003	5.9056	46T	18T	149.986	5.9049	149.961	5.9040	11T	4T
160	160	6.2992	159.975	6.2982	160.021	6.3000	160.003	6.2993			159.986	6.2986	159.961	6.2977		
170	170	6.6929	169.975	6.6919	170.021	6.6937	170.003	6.6930			169.986	6.6923	169.961	6.6914		
180	180	7.0866	179.975	7.0856	180.021	7.0874	180.003	7.0867			179.986	7.0860	179.961	7.0851		
190	190	7.4803	189.970	7.4791	190.024	7.4812	190.004	7.4805			189.985	7.4797	189.956	7.4786		
200	200	7.8740	199.970	7.8728	200.024	7.8749	200.004	7.8742			199.985	7.8734	199.956	7.8723		
210	210	8.2677	209.970	8.2665	210.024	8.2686	210.004	8.2679	4T	2T	209.985	8.2671	209.956	8.2660	44L	17L
220	220	8.6614	219.970	8.6602	220.024	8.6623	220.004	8.6616	54T	21T	219.985	8.6608	219.956	8.6597	15T	6T
230	230	9.0551	229.970	9.0539	230.024	9.0560	230.004	9.0553			229.985	9.0545	229.956	9.0534		
240	240	9.4488	239.970	9.4476	240.024	9.4497	240.004	9.4490			239.985	9.4482	239.956	9.4471		
250	250	9.8425	249.970	9.8413	250.024	9.8434	250.004	9.8427			249.985	9.8419	249.956	9.8408		
260	260	10.2362	259.965	10.2348	260.027	10.2373	260.004	10.2364	4T	2T	259.983	10.2355	259.951	10.2343	49L	19L
280	280	11.0236	279.965	11.0222	280.027	11.0247	280.004	11.0238	62T	25T	279.983	11.0229	279.951	11.0217	18T	7T
300	300	11.8110	299.965	11.8096	300.027	11.8121	300.004	11.8112			299.983	11.8103	299.951	11.8091		
320	320	12.5984	319.960	12.5968	320.029	12.5995	320.004	12.5986	4T	2T	319.982	12.5977	319.946	12.5963	54L	21L
									69T	27T					22T	9T

General Recommended Shaft Limits for Inch-Size Bearings—ISO k5 and g6

mm	Bearing Bore Diameter				Shaft Rotating						Shaft Stationary					
	Max		Min		Shaft Diameter (k5)				Fit		Shaft Diameter (g6)				Fit	
					Max		Min		.001	.0001	Max		Min		.001	.0001
	mm	in	mm	in	mm	in	mm	in	mm	in	mm	in	mm	in	mm	in
R2	3.175	0.1250	3.167	0.1247	3.181	0.1252	3.175	0.1250	0	0	3.171	0.1248	3.163	0.1245	12L	5L
R2A	3.175	0.1250	3.167	0.1247	3.181	0.1252	3.175	0.1250	14T	5T	3.171	0.1248	3.163	0.1245	4T	1T
R3	4.763	0.1875	4.755	0.1872	4.769	0.1877	4.763	0.1875			4.759	0.1873	4.751	0.1870		
R4	6.350	0.2500	6.342	0.2497	6.357	0.2503	6.350	0.2500	0	0	6.345	0.2498	6.336	0.2494	14L	6L
R4A	6.350	0.2500	6.342	0.2497	6.357	0.2503	6.350	0.2500	15T	6T	6.345	0.2498	6.336	0.2494	3T	1T
R6	9.525	0.3750	9.517	0.3747	9.532	0.3753	9.525	0.3750			9.520	0.3748	9.511	0.3744		
R8	12.700	0.5000	12.692	0.4997	12.709	0.5004	12.700	0.5000	0	0	12.694	0.4998	12.683	0.4993	17L	7L
R10	15.875	0.6250	15.867	0.6247	15.884	0.6254	15.875	0.6250	17T	7T	15.869	0.6248	15.858	0.6243	2T	1T
R12	19.050	0.7500	19.040	0.7496	19.061	0.7504	19.052	0.7501			19.043	0.7497	19.030	0.7492		
R14	22.225	0.8750	22.215	0.8746	22.236	0.8754	22.227	0.8751	2T	1T	22.218	0.8747	22.205	0.8742	20L	8L
R16	25.400	1.0000	25.390	0.9996	25.411	1.0004	25.402	1.0001	21T	8T	25.393	0.9997	25.380	0.9992	3T	1T
R18	28.575	1.1250	28.565	1.1246	28.586	1.1254	28.577	1.1251			28.568	1.1247	28.555	1.1242		
R20	31.750	1.2500	31.737	1.2495	31.763	1.2505	31.752	1.2501			31.741	1.2496	31.725	1.2490		
R24	38.100	1.5000	38.087	1.4995	38.113	1.5005	38.102	1.5001			38.091	1.4996	38.075	1.4990		
XLS1 ³ / ₈	34.925	1.3750	34.912	1.3745	34.938	1.3755	34.927	1.3751	2T	1T	34.916	1.3746	34.900	1.3740	25L	10L
XLS1 ¹ / ₂	38.100	1.5000	38.087	1.4995	38.113	1.5005	38.102	1.5001	26T	10T	38.091	1.4996	38.075	1.4990	4T	1T
XLS1 ⁵ / ₈	41.275	1.6250	41.262	1.6245	41.288	1.6255	41.277	1.6251			41.266	1.6246	41.250	1.6240		
XLS1 ³ / ₄	44.450	1.7500	44.437	1.7495	44.463	1.7505	44.452	1.7501			44.441	1.7496	44.425	1.7490		
XLS1 ⁷ / ₈	47.625	1.8750	47.612	1.8745	47.638	1.8755	47.627	1.8751			47.616	1.8746	47.600	1.8740		
XLS2	50.800	2.0000	50.785	1.9994	50.815	2.0006	50.802	2.0001			50.790	1.9996	50.771	1.9989		
XLS2 ¹ / ₈	53.975	2.1250	53.960	2.1244	53.990	2.1256	53.977	2.1251			53.965	2.1246	53.946	2.1239		
XLS2 ¹ / ₄	57.150	2.2500	57.135	2.2494	57.165	2.2506	57.152	2.2501	2T	1T	57.140	2.2496	57.121	2.2489	29L	11L
XLS2 ¹ / ₂	63.500	2.5000	63.485	2.4994	63.515	2.5006	63.502	2.5001	30T	12T	63.490	2.4996	63.471	2.4989	5T	2T
XLS2 ³ / ₈	66.675	2.6250	66.660	2.6244	66.690	2.6256	66.677	2.6251			66.665	2.6246	66.646	2.6239		
XLS2 ³ / ₄	69.850	2.7500	69.835	2.7494	69.865	2.7506	69.852	2.7501			69.840	2.7496	69.821	2.7489		
XLS3	76.200	3.0000	76.185	2.9994	76.215	3.0006	76.202	3.0001			76.190	2.9996	76.171	2.9989		
XLS3 ¹ / ₄	82.550	3.2500	82.530	3.2492	82.568	3.2507	82.553	3.2501			82.538	3.2495	82.516	3.2487		
XLS3 ¹ / ₂	88.900	3.5000	88.880	3.4992	88.918	3.5007	88.903	3.5001	3T	1T	88.888	3.4995	88.866	3.4987	34L	13L
XLS3 ³ / ₄	95.250	3.7500	95.230	3.7492	95.268	3.7507	95.253	3.7501	38T	15T	95.238	3.7495	95.216	3.7487	8T	3T
XLS4 ¹ / ₄	107.950	4.2500	107.935	4.2492	107.973	4.2507	107.953	4.2501			107.943	4.2495	107.916	4.2487		
XLS4 ¹ / ₂	114.300	4.5000	114.285	4.4992	114.323	4.5007	114.303	4.5001			114.293	4.4995	114.266	4.4987		
XLS4 ³ / ₄	120.650	4.7500	120.625	4.7490	120.671	4.7508	120.653	4.7501			120.636	4.7494	120.611	4.7485		
XLS5	127.000	5.0000	126.975	4.9990	127.021	5.0008	127.003	5.0001			126.986	4.9994	126.961	4.9985		
XLS5 ¹ / ₂	139.700	5.5000	139.675	5.4990	139.721	5.5008	139.703	5.5001	3T	1T	139.686	5.4994	139.661	5.4985	39L	15L
XLS6	152.400	6.0000	152.375	5.9990	152.421	6.0008	152.403	6.0001	46T	18T	152.386	5.9994	152.361	5.9985	11T	4T
XLS6 ¹ / ₄	158.750	6.2500	158.735	6.2490	158.781	6.2508	158.753	6.2501			158.746	6.2494	158.711	6.2485		
XLS6 ¹ / ₂	165.100	6.5000	165.075	6.4990	165.121	6.5008	165.103	6.5001			165.086	6.4994	165.061	6.4985		
XLS7	177.800	7.0000	177.775	6.9990	177.821	7.0008	177.803	7.0001			177.786	6.9994	177.761	6.9985		
XLS7 ¹ / ₄	184.150	7.2500	184.120	7.2488	184.174	7.2509	184.154	7.2502			184.135	7.2494	184.106	7.2483		
XLS7 ³ / ₈	196.850	7.7500	196.820	7.7488	196.874	7.7509	196.854	7.7502			196.835	7.7494	196.806	7.7483	44L	17L
XLS8	203.200	8.0000	203.170	7.9988	203.224	8.0009	203.204	8.0002	4T	2T	203.185	7.9994	203.156	7.9983	15T	6T
XLS8 ¹ / ₄	209.950	8.2500	209.920	8.2488	209.974	8.2509	209.954	8.2502	54T	21T	209.935	8.2494	209.906	8.2483		
XLS8 ¹ / ₂	215.900	8.5000	215.870	8.4988	215.924	8.5009	215.904	8.5002			215.885	8.4994	215.856	8.4983		
XLS9	228.600	9.0000	228.570	8.9988	228.624	9.0009	228.604	9.0002			228.585	8.9994	228.556	8.9983		
XLS10	254.000	10.0000	253.965	9.9986	254.027	10.0011	254.004	10.0002	4T	2T	253.983	9.9993	253.951	9.9981	49L	19L
									62T	25T					18T	7T

General Recommended Housing Bore Limits for Metric Bearings—ISO H6 and N6

Bearing Outside Diameter				Housing Stationary								Housing Rotating							
Max		Min		Housing Bore (H6)				Fit		Housing Bore (N6)				Fit					
mm		mm		Max		Min		.001	.0001	Max		Min		.001	.0001				
mm	in	mm	in	mm	in	mm	in	mm	in	mm	in	mm	in	mm	in				
16	16	0.6299	15.992	0.6296	16.011	0.6303	16	0.6299	19L 0	7L 0	15.993	0.6295	15.980	0.6291	2T 20T	1T 8T			
19	19	0.7480	18.991	0.7476	19.013	0.7485	19	0.7480			18.989	0.7476	18.976	0.7471					
21	21	0.8268	20.991	0.8264	21.013	0.8273	21	0.8268			20.989	0.8264	20.976	0.8259					
22	22	0.8661	21.991	0.8657	22.013	0.8666	22	0.8661			21.989	0.8657	21.976	0.8652					
24	24	0.9449	23.991	0.9445	24.013	0.9454	24	0.9449	22L 0	9L 0	23.989	0.9445	23.976	0.9440	2T	0 9T			
26	26	1.0236	25.991	1.0232	26.013	1.0241	26	1.0236			25.989	1.0232	25.976	1.0227	24T				
28	28	1.1024	27.991	1.1020	28.013	1.1029	28	1.1024			27.989	1.1020	27.976	1.1015					
30	30	1.1811	29.991	1.1807	30.013	1.1816	30	1.1811			29.989	1.1807	29.976	1.1802					
32	32	1.2598	31.989	1.2593	32.016	1.2604	32	1.2598			31.988	1.2593	31.972	1.2587					
35	35	1.3780	34.989	1.3775	35.016	1.3786	35	1.3780			34.988	1.3775	34.972	1.3769					
37	37	1.4567	36.989	1.4562	37.016	1.4573	37	1.4567	27L 0	11L 0	36.988	1.4562	36.972	1.4556	1T	0 11T			
40	40	1.5748	39.989	1.5743	40.016	1.5754	40	1.5748			39.988	1.5743	39.972	1.5737	28T				
42	42	1.6535	41.989	1.6530	42.016	1.6541	42	1.6535			41.988	1.6530	41.972	1.6524					
47	47	1.8504	46.989	1.8499	47.016	1.8510	47	1.8504			46.988	1.8499	46.972	1.8493					
52	52	2.0472	51.987	2.0467	52.019	2.0479	52	2.0472			51.986	2.0466	51.967	2.0459					
55	55	2.1654	54.987	2.1649	55.019	2.1661	55	2.1654			54.986	2.1648	54.967	2.1641					
58	58	2.2835	57.987	2.2830	58.019	2.2842	58	2.2835			57.986	2.2829	57.967	2.2822					
62	62	2.4409	61.987	2.4404	62.019	2.4416	62	2.4409			61.986	2.4403	61.967	2.4396	1T	1T			
65	65	2.5591	64.987	2.5586	65.019	2.5598	65	2.5591	32L 0	12L 0	64.986	2.5585	64.967	2.5578	33T	13T			
68	68	2.6772	67.987	2.6767	68.019	2.6779	68	2.6772			67.986	2.6766	67.967	2.6759					
70	70	2.7559	69.987	2.7554	70.019	2.7566	70	2.7559			69.986	2.7553	69.967	2.7546					
72	72	2.8346	71.987	2.8341	72.019	2.8353	72	2.8346			71.986	2.8340	71.967	2.8333					
75	75	2.9528	74.987	2.9523	75.019	2.9535	75	2.9528			74.986	2.9522	74.967	2.9515					
78	78	3.0709	77.987	3.0704	78.019	3.0716	78	3.0709			77.986	3.0703	77.967	3.0696					
80	80	3.1496	79.987	3.1491	80.019	3.1503	80	3.1496			79.986	3.1490	79.967	3.1483					
85	85	3.3465	84.985	3.3459	85.022	3.3474	85	3.3465			84.984	3.3459	84.962	3.3450					
90	90	3.5433	89.985	3.5427	90.022	3.5442	90	3.5433			89.984	3.5427	89.962	3.5418					
95	95	3.7402	94.985	3.7396	95.022	3.7411	95	3.7402			94.984	3.7396	94.962	3.7387					
100	100	3.9370	99.985	3.9364	100.022	3.9379	100	3.9370	37L 0	15L 0	99.984	3.9364	99.962	3.9355	1T	0 15T			
105	105	4.1339	104.985	4.1333	105.022	4.1348	105	4.1339			104.984	4.1333	104.962	4.1324	38T				
110	110	4.3307	109.985	4.3301	110.022	4.3316	110	4.3307			109.984	4.3301	109.962	4.3292					
115	115	4.5276	114.985	4.5270	115.022	4.5285	115	4.5276			114.984	4.5270	114.962	4.5261					
120	120	4.7244	119.985	4.7238	120.022	4.7253	120	4.7244			119.984	4.7238	119.962	4.7229					
125	125	4.9213	124.982	4.9206	125.025	4.9223	125	4.9213			124.980	4.9205	124.955	4.9195					
130	130	5.1181	129.982	5.1174	130.025	5.1191	130	5.1181			129.980	5.1173	129.955	5.1163					
135	135	5.3150	134.982	5.3143	135.025	5.3160	135	5.3150			134.980	5.3142	134.955	5.3132					
140	140	5.5118	139.982	5.5111	140.025	5.5128	140	5.5118	43L 0	17L 0	139.980	5.5110	139.955	5.5100	2T	1T 18T			
145	145	5.7087	144.982	5.7080	145.025	5.7097	145	5.7087			144.980	5.7079	144.955	5.7069	45T				
150	150	5.9055	149.982	5.9048	150.025	5.9065	150	5.9055			149.980	5.9047	149.955	5.9037					
160	160	6.2992	159.975	6.2982	160.025	6.3002	160	6.2992	50L 0	20L 0	159.980	6.2984	159.955	6.2973	5L	2L 19T			
165	165	6.4961	164.975	6.4951	165.025	6.4971	165	6.4961			164.980	6.4953	164.955	6.4942					
170	170	6.6929	169.975	6.6919	170.025	6.6939	170	6.6929			169.980	6.6921	169.955	6.6910					
175	175	6.8898	174.975	6.8888	175.025	6.8908	175	6.8898			174.980	6.8890	174.955	6.8879					
180	180	7.0866	179.975	7.0856	180.025	7.0876	180	7.0866			179.980	7.0858	179.955	7.0847					
190	190	7.4803	189.970	7.4791	190.029	7.4814	190	7.4803			189.978	7.4794	189.949	7.4793					
200	200	7.8740	199.970	7.8728	200.029	7.8751	200	7.8740			199.978	7.8731	199.949	7.8720					
205	205	8.0709	204.970	8.0697	205.029	8.0720	205	8.0709			204.978	8.0700	204.949	8.0689					
210	210	8.2677	209.970	8.2665	210.029	8.2688	210	8.2677			209.978	8.2668	209.949	8.2657					
215	215	8.4646	214.970	8.4634	215.029	8.4657	215	8.4646	59L 0	23L 0	214.978	8.4637	214.949	8.4626	8L	3L 20T			
220	220	8.6614	219.970	8.6602	220.029	8.6625	220	8.6614			219.978	8.6605	219.949	8.6594	51T				
225	225	8.8583	224.970	8.8571	225.029	8.8594	225	8.8583			224.978	8.8574	224.949	8.8563					
230	230	9.0551	229.970	9.0539	230.029	9.0562	230	9.0551			229.978	9.0542	229.949	9.0531					
235	235	9.2520	234.970	9.2508	235.029	9.2531	235	9.2520			234.978	9.2511	234.949	9.2500					
240	240	9.4488	239.970	9.4476	240.029	9.4499	240	9.4488			239.978	9.4479	239.949	9.4468					
250	250	9.8425	249.970	9.8413	250.029	9.8436	250	9.8425			249.978	9.8416	249.949	9.8405					
260	260	10.2362	259.965	10.2348	260.032	10.2375	260	10.2362			259.975	10.2352	259.943	10.2340					
265	265	10.4331	264.965	10.4317	265.032	10.4344	265	10.4331			264.975	10.4321	264.943	10.4309					
270	270	10.6299	269.965	10.6285	270.032	10.6312	270	10.6299			269.975	10.6289	269.943	10.6277					
280	280	11.0236	279.965	11.0222	280.032	11.0249	280	11.0236	67L 0	27L 0	279.975	11.0226	279.943	11.0214	10L	4L 22T			
290	290	11.4173	289.965	11.4159	290.032	11.4186	290	11.4173			289.975	11.4163	289.943	11.4151	57T				
300	300	11.8110	299.965	11.8096	300.032	11.8123	300	11.8110			299.975	11.8100	299.943	11.8088					
310	310	12.2047	309.965	12.2033	310.032	12.2060	310	12.2047			309.975	12.2037	309.943	12.2025					
320	320	12.5984	319.960	12.5968	320.036	12.5998	320	12.5984			319.974	12.5974	319.939	12.5960					
340	340	13.3858	339.960	13.3842	340.036	13.3872	340	13.3858			339.974	13.3848	339.939	13.3834					
350	350	13.7795	349.960	13.7779	350.036	13.7809	350	13.7795			349.974	13.7785	349.939	13.7771					
360	360	14.1732	359.960	14.1716	360.036	14.1746	360	14.1732	76L 0	30L 0	359.974	14.1722	359.939						

General Recommended Housing Bore Limits for Inch-Size Bearings— ISO H6 and N6

mm	Bearing Outside Diameter				Housing Stationary						Housing Rotating					
	Max		Min		Housing Bore (H6)				Fit		Housing Bore (N6)				Fit	
					Max		Min		.001 mm	.0001 in	Max		Min		.001 mm	.0001 in
	mm	in	mm	in	mm	in	mm	in			mm	in	mm	in		
R2	9.525	0.3750	9.517	0.3747	9.536	0.3754	9.525	0.3750			9.515	0.3746	9.505	0.3742		
R2A	12.700	0.5000	12.692	0.4997	12.711	0.5004	12.700	0.5000	19L	7L	12.690	0.4996	12.680	0.4992	2T	1T
R3	12.700	0.5000	12.692	0.4997	12.711	0.5004	12.700	0.5000	0	0	12.690	0.4996	12.680	0.4992	20T	8T
R4	15.875	0.6250	15.867	0.6247	15.886	0.6254	15.875	0.6250			15.865	0.6246	15.855	0.6242		
R4A	19.050	0.7500	19.041	0.7496	19.063	0.7505	19.050	0.7500	22L	9L	19.039	0.7496	19.026	0.7491	2T	0
R6	22.225	0.8750	22.216	0.8746	22.238	0.8755	22.225	0.8750	0	0	22.214	0.8746	22.201	0.8741	24T	9T
R8	28.575	1.1250	28.566	1.1246	28.588	1.1255	28.575	1.1250			28.564	1.1246	28.551	1.1241		
R10	34.925	1.3750	34.914	1.3745	34.941	1.3756	34.925	1.3750	27L	11L	34.913	1.3744	34.897	1.3739	1T	1T
R12	41.275	1.6250	41.264	1.6245	41.291	1.6256	41.275	1.6250	0	0	41.263	1.6244	41.247	1.6239	28T	11T
R14	47.625	1.8750	47.614	1.8745	47.641	1.8756	47.625	1.8750			47.613	1.8744	47.597	1.8739		
R16	50.800	2.0000	50.787	1.9995	50.819	2.0007	50.800	2.0000			50.786	1.9994	50.767	1.9987		
R18	53.975	2.1250	53.962	2.1245	53.994	2.1257	53.975	2.1250			53.961	2.1244	53.942	2.1237		
R20	57.150	2.2500	57.137	2.2495	57.169	2.2507	57.150	2.2500	32L	12L	57.136	2.2494	57.117	2.2487	1T	1T
R24	66.675	2.6250	66.662	2.6245	66.694	2.6257	66.675	2.6250	0	0	66.661	2.6244	66.642	2.6237	33T	13T
XLS1 ³ / ₈	65.088	2.5625	65.151	2.5620	65.183	2.5632	65.088	2.5625			65.150	2.5619	65.055	2.5612		
XLS1 ¹ / ₂	68.263	2.6875	68.250	2.6870	68.282	2.6882	68.263	2.6875			68.249	2.6869	68.230	2.6862		
XLS1 ³ / ₄	73.025	2.8750	73.012	2.8745	73.044	2.8757	73.025	2.8750			73.011	2.8744	72.992	2.8737		
XLS1 ⁷ / ₈	76.200	3.0000	76.187	2.9995	76.219	3.0007	76.200	3.0000			76.186	2.9994	76.167	2.9987		
XLS1 ¹ / ₈	80.963	3.1875	80.948	3.1869	80.985	3.1884	80.963	3.1875			80.947	3.1869	80.925	3.1860		
XLS2	84.138	3.3125	84.123	3.3119	84.160	3.3134	84.138	3.3125			84.122	3.3119	84.100	3.3110		
XLS2 ¹ / ₈	87.313	3.4375	87.298	3.4369	87.335	3.4384	87.313	3.4375	37L	15L	87.297	3.4369	87.275	3.4360	1T	0
XLS2 ¹ / ₄	90.488	3.5625	90.473	3.5619	90.510	3.5634	90.488	3.5625	0	0	90.472	3.5619	90.450	3.5610	38T	15T
XLS2 ¹ / ₂	98.425	3.8750	98.410	3.8744	98.447	3.8759	98.425	3.8750			98.409	3.8744	98.387	3.8735		
XLS2 ³ / ₈	104.775	4.1250	104.760	4.1244	104.797	4.1259	104.775	4.1250			104.759	4.1244	104.737	4.1235		
XLS2 ¹ / ₂	104.775	4.1250	104.760	4.1244	104.797	4.1259	104.775	4.1250			104.759	4.1244	104.737	4.1235		
XLS3	114.300	4.5000	114.285	4.4994	114.322	4.5009	114.300	4.5000			114.284	4.4994	114.262	4.4985		
XLS3 ¹ / ₄	120.650	4.7500	120.632	4.7493	120.675	4.7510	120.650	4.7500	43L	17L	120.630	4.7492	120.605	4.7482	2T	1T
XLS3 ¹ / ₂	127.000	5.0000	126.982	4.9993	126.995	5.0010	127.000	5.0000	0	0	126.980	4.9992	126.955	4.9982	45T	18T
XLS3 ³ / ₄	133.350	5.2500	133.332	5.2493	133.375	5.2510	133.350	5.2500			133.330	5.2492	133.305	5.2482		
XLS4 ¹ / ₄	152.400	6.0000	152.375	5.9990	152.425	6.0010	152.400	6.0000			152.380	5.9992	152.355	5.9981		
XLS4 ¹ / ₂	158.750	6.2500	158.725	6.2490	158.775	6.2510	158.750	6.2500	50L	20L	158.730	6.2492	158.705	6.2481	5L	2L
XLS4 ³ / ₄	165.100	6.5000	165.075	6.4990	165.125	6.5010	165.100	6.5000	0	0	165.080	6.4992	165.055	6.4981	45T	18T
XLS5	177.800	7.0000	177.775	6.9990	177.825	7.0010	177.800	7.0000			177.780	6.9992	177.755	6.9981		
XLS5 ¹ / ₂	190.500	7.5000	190.470	7.4988	190.529	7.5011	190.500	7.5000			190.478	7.4991	190.449	7.4980		
XLS6	203.200	8.0000	203.170	7.9988	203.229	8.0011	203.200	8.0000			203.178	7.9991	203.149	7.9980		
XLS6 ¹ / ₄	215.900	8.5000	215.870	8.4988	215.929	8.5011	215.900	8.5000	59L	23L	215.878	8.4991	215.849	8.4980	8L	3L
XLS6 ¹ / ₂	222.250	8.7500	222.220	8.7488	222.279	8.7511	222.250	8.7500	0	0	222.228	8.7491	222.199	8.7480	51T	20T
XLS7	241.300	9.5000	241.270	9.4988	241.329	9.5011	241.300	9.5000			241.278	9.4991	241.249	9.4980		
XLS7 ¹ / ₄	247.650	9.7500	247.620	9.7488	247.679	9.7511	247.650	9.7500			247.628	9.7491	247.599	9.7480		
XLS7 ³ / ₄	266.700	10.5000	266.665	10.4986	266.732	10.5013	266.700	10.5000			266.675	10.4990	266.643	10.4978		
XLS8	273.051	10.7500	273.016	10.7486	273.083	10.7513	273.051	10.7500	67L	27L	273.026	10.7490	272.994	10.7478	10L	4L
XLS8 ¹ / ₄	279.401	11.0000	279.366	10.9986	279.433	11.0013	279.401	11.0000	0	0	279.376	10.9990	279.344	10.9978	57T	22T
XLS8 ¹ / ₂	292.101	11.5000	292.066	11.4986	292.133	11.5013	292.101	11.5000			292.076	11.4990	292.044	11.4978		
XLS9	304.801	12.0000	304.766	11.9986	304.833	12.0013	304.801	12.0000			304.776	11.9990	304.744	11.9978		
XLS10	336.551	13.2500	336.514	13.2484	336.587	13.2514	336.551	13.2500	76L	30L	336.525	13.2490	336.489	13.2476	14L	6L
									0	0					62T	24T

For aluminum or other soft metal housings make bore limits same as bearing O.D. limits.

General Recommended Shaft Limits for Metric Bearings—ISO k5 and g6

Bearing Bore Diameter				Shaft Rotating						Shaft Stationary						
mm	Max		Min		Shaft Diameter (k5)				Fit		Shaft Diameter (g6)				Fit	
	mm	in	mm	in	Max		Min		.001 mm	.0001 in	Max		Min		.001 mm	.0001 in
					mm	in	mm	in			mm	in	mm	in		
4	4	0.1575	3.993	0.1572	4.006	0.1577	4.000	0.1575	0	0	3.996	0.1573	3.988	0.1570	12L	5L
5	5	0.1969	4.993	0.1966	5.006	0.1971	5.000	0.1969	13T	5T	4.996	0.1967	4.988	0.1964	3T	1T
6	6	0.2362	5.993	0.2359	6.006	0.2364	6.000	0.2362			5.996	0.2360	5.988	0.2357		
7	7	0.2756	6.993	0.2753	7.007	0.2759	7.000	0.2756			6.995	0.2754	6.986	0.2750		
8	8	0.3150	7.993	0.3147	8.007	0.3153	8.000	0.3150	0	0	7.995	0.3148	7.986	0.3144	14L	6L
9	9	0.3543	8.993	0.3540	9.007	0.3546	9.000	0.3543	14T	6T	8.995	0.3541	8.986	0.3537	2T	1T
10	10	0.3937	9.993	0.3934	10.007	0.3940	10.000	0.3937			9.995	0.3935	9.986	0.3931		
12	12	0.4724	11.993	0.4721	12.009	0.4728	12.000	0.4724	0	0	11.994	0.4722	11.983	0.4717	17L	7L
15	15	0.5906	14.993	0.5903	15.009	0.5910	15.000	0.5906	16T	7T	14.994	0.5904	14.983	0.5899	1T	1T
17	17	0.6693	16.993	0.6690	17.009	0.6697	17.000	0.6693			16.994	0.6691	16.983	0.6686		
20	20	0.7874	19.992	0.7871	20.011	0.7878	20.002	0.7875	2T	1T	19.993	0.7871	19.980	0.7866	20L	8L
25	25	0.9843	24.992	0.9840	25.011	0.9847	25.002	0.9844	19T	7T	24.993	0.9840	24.980	0.9835	1T	0
30	30	1.1811	29.992	1.1808	30.011	1.1815	30.002	1.1812			29.993	1.1808	29.980	1.1803		
35	35	1.3780	34.990	1.3776	35.013	1.3785	35.002	1.3781			34.991	1.3776	34.975	1.3770		
40	40	1.5748	39.990	1.5744	40.013	1.5753	40.002	1.5749	2T	1T	39.991	1.5744	39.975	1.5738	25L	10L
45	45	1.7717	44.990	1.7713	45.013	1.7722	45.002	1.7718	23T	9T	44.991	1.7713	44.975	1.7707	1T	0
50	50	1.9685	49.990	1.9681	50.013	1.9690	50.002	1.9686			49.991	1.9681	49.975	1.9675		
55	55	2.1654	54.988	2.1649	55.015	2.1660	55.002	2.1655			54.990	2.1650	54.971	2.1643		
60	60	2.3622	59.988	2.3617	60.015	2.3628	60.002	2.3623			59.990	2.3618	59.971	2.3611		
65	65	2.5591	64.988	2.5586	65.015	2.5597	65.002	2.5592	2T	1T	64.990	2.5587	64.971	2.5580	29L	11L
70	70	2.7559	69.988	2.7554	70.015	2.7565	70.002	2.7560	27T	11T	69.990	2.7555	69.971	2.7548	2T	1T
75	75	2.9528	74.988	2.9523	75.015	2.9534	75.002	2.9529			74.990	2.9524	74.971	2.9517		
80	80	3.1496	79.988	3.1491	80.015	3.1502	80.002	3.1497			79.990	3.1492	79.971	3.1485		
85	85	3.3465	84.985	3.3459	85.018	3.3472	85.003	3.3466			84.988	3.3460	84.966	3.3452		
90	90	3.5433	89.985	3.5427	90.018	3.5440	90.003	3.5434			89.988	3.5428	89.966	3.5420		
95	95	3.7402	94.985	3.7396	95.018	3.7409	95.003	3.7403	3T	1T	94.988	3.7397	94.966	3.7389	34L	13L
100	100	3.9370	99.985	3.9364	100.018	3.9377	100.003	3.9371	33T	13T	99.988	3.9365	99.966	3.9357	3T	1T
105	105	4.1339	104.985	4.1333	105.018	4.1346	105.003	4.1340			104.988	4.1334	104.966	4.1326		
110	110	4.3307	109.985	4.3301	110.018	4.3314	110.003	4.3308			109.988	4.3302	109.966	4.3294		
115	115	4.5276	114.985	4.5270	115.018	4.5283	115.003	4.5277			114.988	4.5271	114.966	4.5263		
120	120	4.7244	119.985	4.7238	120.018	4.7251	120.003	4.7245			119.988	4.7239	119.966	4.7231		
125	125	4.9213	124.982	4.9206	125.021	4.9221	125.003	4.9214			124.986	4.9207	124.961	4.9198		
130	130	5.1181	129.982	5.1174	130.021	5.1189	130.003	5.1182			129.986	5.1175	129.961	5.1166		
140	140	5.5118	139.982	5.5111	140.021	5.5126	140.003	5.5119	3T	1T	139.986	5.5112	139.961	5.5103	39L	15L
150	150	5.9055	149.982	5.9048	150.021	5.9063	150.003	5.9056	39T	15T	149.986	5.9049	149.961	5.9040	4T	1T
160	160	6.2992	159.982	6.2985	160.021	6.3000	160.003	6.2993			159.986	6.2986	159.961	6.2977		
170	170	6.6929	169.982	6.6922	170.021	6.6937	170.003	6.6930			169.986	6.6923	169.961	6.6914		
180	180	7.0866	179.982	7.0859	180.021	7.0874	180.003	7.0867			179.986	7.0860	179.961	7.0851		
190	190	7.4803	189.978	7.4794	190.024	7.4812	190.004	7.4805			189.985	7.4797	189.956	7.4786		
200	200	7.8740	199.978	7.8731	200.024	7.8749	200.004	7.8742			199.985	7.8734	199.956	7.8723		
210	210	8.2677	209.978	8.2668	210.024	8.2684	210.004	8.2679	4T	2T	209.985	8.2671	209.956	8.2660		
220	220	8.6614	219.978	8.6605	220.024	8.6623	220.004	8.6616			219.985	8.6608	219.956	8.6597	44L	17L
230	230	9.0551	229.978	9.0542	230.024	9.0560	230.004	9.0553	46T	18T	229.985	9.0545	229.956	9.0534	7T	3T
240	240	9.4488	239.978	9.4479	240.024	9.4497	240.004	9.4490			239.985	9.4482	239.956	9.4471		
250	250	9.8425	249.978	9.8416	250.024	9.8434	250.004	9.8427			249.985	9.8419	249.956	9.8408		
260	260	10.2362	259.975	10.2352	260.027	10.2373	260.004	10.2364	4T	2T	259.983	10.2355	259.951	10.2343	49L	19L
280	280	11.0236	279.975	11.0226	280.027	11.0247	280.004	11.0238	52T	21T	279.983	11.0229	279.951	11.0217	8T	3T
300	300	11.8110	299.975	11.8100	300.027	11.8121	300.004	11.8112			299.983	11.8103	299.951	11.8091		
320	320	12.5984	319.970	12.5972	320.029	12.5995	320.004	12.5986	4T 59T	2T 23T	319.982	12.5977	319.946	12.5963	54L 12T	21L 5T

General Recommended Shaft Limits for Inch-Size Bearings—ISO k5 and g6

mm	Bearing Bore Diameter				Shaft Rotating						Shaft Stationary					
	Max		Min		Shaft Diameter (k5)				Fit		Shaft Diameter (g6)				Fit	
					Max		Min		.001	.0001	Max		Min		.001	.0001
	mm	in	mm	in	mm	in	mm	in			mm	in	mm	in		
R2	3.175	0.1250	3.168	0.1247	3.181	0.1252	3.175	0.1250	0	0	3.171	0.1248	3.163	0.1245	12L	5L
R2A	3.175	0.1250	3.168	0.1247	3.181	0.1252	3.175	0.1250	13T	5T	3.171	0.1248	3.163	0.1245	3T	1T
R3	4.763	0.1875	4.756	0.1872	4.769	0.1877	4.768	0.1875			4.759	0.1873	4.751	0.1870		
R4	6.350	0.2500	6.343	0.2497	6.357	0.2503	6.350	0.2500	0	0	6.345	0.2498	6.336	0.2494	14L	6L
R4A	6.350	0.2500	6.343	0.2497	6.357	0.2503	6.350	0.2500	14T	6T	6.345	0.2498	6.336	0.2494	2T	1T
R6	9.525	0.3750	9.518	0.3747	9.532	0.3753	9.525	0.3750			9.520	0.3748	9.511	0.3744		
R8	12.700	0.5000	12.693	0.4997	12.709	0.5004	12.700	0.5000	0	0	12.694	0.4998	12.683	0.4993	17L	7L
R10	15.875	0.6250	15.868	0.6247	15.884	0.6254	15.875	0.6250	16T	7T	15.869	0.6248	15.858	0.6243	1T	1T
R12	19.050	0.7500	19.042	0.7497	19.061	0.7504	19.052	0.7501			19.043	0.7497	19.030	0.7492		
R14	22.225	0.8750	22.217	0.8747	22.236	0.8754	22.227	0.8751	2T	1T	22.218	0.8747	22.205	0.8742	20L	8L
R16	25.400	1.0000	25.392	0.9997	25.411	1.0004	25.402	1.0001	19T	7T	25.393	0.9997	25.380	0.9992	1T	0
R18	28.575	1.1250	28.567	1.1247	28.586	1.1254	28.577	1.1251			28.568	1.1247	28.555	1.1242		
R20	31.750	1.2500	31.740	1.2496	31.763	1.2505	31.752	1.2501			31.741	1.2496	31.725	1.2490		
R24	38.100	1.5000	38.090	1.4996	38.113	1.5005	38.102	1.5001			38.091	1.4996	38.075	1.4990		
XLS1 ³ / ₈	34.925	1.3750	34.915	1.3746	34.938	1.3755	34.927	1.3751	2T	1T	34.916	1.3746	34.900	1.3740	25L	10L
XLS1 ¹ / ₂	38.100	1.5000	38.090	1.4996	38.113	1.5005	38.102	1.5001	23T	9T	38.091	1.4996	38.075	1.4990	1T	0
XLS1 ¹ / ₄	41.275	1.6250	41.265	1.6246	41.288	1.6255	41.277	1.6251			41.266	1.6246	41.250	1.6240		
XLS1 ³ / ₄	44.450	1.7500	44.440	1.7496	44.463	1.7505	44.452	1.7501			44.441	1.7496	44.425	1.7490		
XLS1 ⁷ / ₈	47.625	1.8750	47.615	1.8746	47.638	1.8755	47.627	1.8751			47.616	1.8746	47.600	1.8740		
XLS2	50.800	2.0000	50.788	1.9995	50.815	2.0006	50.802	2.0001			50.790	1.9996	50.771	1.9989		
XLS2 ¹ / ₂	53.975	2.1250	53.963	2.1245	53.990	2.1256	53.977	2.1251			53.965	2.1246	53.946	2.1239		
XLS2 ³ / ₄	57.150	2.2500	57.138	2.2495	57.165	2.2506	57.152	2.2501	2T	1T	57.140	2.2496	57.121	2.2489	29L	11L
XLS2 ¹ / ₄	63.500	2.5000	63.488	2.4995	63.515	2.5006	63.502	2.5001	27T	11T	63.490	2.4996	63.471	2.4989	2T	1T
XLS2 ³ / ₈	66.675	2.6250	66.663	2.6245	66.690	2.6256	66.677	2.6251			66.665	2.6246	66.646	2.6239		
XLS2 ⁵ / ₈	69.850	2.7500	69.838	2.7495	69.865	2.7506	69.852	2.7501			69.840	2.7496	69.821	2.7489		
XLS3	76.200	3.0000	76.188	2.9995	76.215	3.0006	76.202	3.0001			76.190	2.9996	76.121	2.9989		
XLS3 ³ / ₄	82.550	3.2500	82.538	3.2494	82.568	3.2507	82.553	3.2501	3T	1T	82.538	3.2495	82.516	3.2487		
XLS3 ¹ / ₂	88.900	3.5000	88.885	3.4994	88.918	3.5007	88.903	3.5001	33T	13T	88.888	3.4995	88.866	3.4987	34L	13L
XLS3 ³ / ₈	95.250	3.7500	95.235	3.7494	95.268	3.7507	95.253	3.7501			95.238	3.7495	95.216	3.7487	3T	1T
XLS4 ¹ / ₄	107.950	4.2500	107.935	4.2494	107.968	4.2507	107.953	4.2501			107.938	4.2495	107.916	4.2487		
XLS4 ³ / ₈	114.300	4.5000	114.285	4.4994	114.318	4.5007	114.303	4.5001			114.288	4.4995	114.266	4.4987		
XLS4 ¹ / ₂	120.650	4.7500	120.632	4.7493	120.671	4.7508	120.653	4.7501			120.636	4.7494	120.611	4.7485		
XLS5	127.000	5.0000	126.982	4.9993	127.021	5.0008	127.003	5.0001			126.986	4.9994	126.961	4.9985		
XLS5 ¹ / ₂	139.700	5.5000	139.682	5.4993	139.721	5.5008	139.703	5.5001	3T	1T	139.686	5.4994	139.661	5.4985	39L	15L
XLS6	152.400	6.0000	152.382	5.9993	152.421	6.0008	152.403	6.0001	39T	15T	152.386	5.9994	152.361	5.9985	4T	1T
XLS6 ¹ / ₄	158.750	6.2500	158.732	6.2493	158.771	6.2508	158.753	6.2501			158.736	6.2494	158.711	6.2485		
XLS6 ³ / ₈	165.100	6.5000	165.082	6.4993	165.121	6.5008	165.103	6.5001			165.086	6.4994	165.061	6.4985		
XLS7	177.800	7.0000	177.782	6.9993	177.821	7.0008	177.803	7.0001			177.786	6.9994	177.761	6.9985		
XLS7 ¹ / ₄	184.150	7.2500	184.128	7.2491	184.174	7.2509	184.154	7.2502			184.135	7.2494	184.106	7.2483		
XLS7 ³ / ₈	196.850	7.7500	196.828	7.7491	196.874	7.7509	196.854	7.7502			196.835	7.7494	196.806	7.7483		
XLS8	203.200	8.0000	203.178	7.9991	203.224	8.0009	203.204	8.0002	4T	2T	203.185	7.9994	203.156	7.9983	44L	17L
XLS8 ¹ / ₄	209.950	8.2500	209.928	8.2491	209.974	8.2509	209.954	8.2502	46T	18T	209.935	8.2494	209.906	8.2483	7T	3T
XLS8 ³ / ₈	215.900	8.5000	215.878	8.4991	215.924	8.5009	215.904	8.5002			215.885	8.4994	215.856	8.4983		
XLS9	228.600	9.0000	228.578	8.9991	228.624	9.0009	228.604	9.0002			228.585	8.9994	228.556	8.9983		
XLS10	254.000	10.0000	253.975	9.9990	254.027	10.0011	254.004	10.0002	4T	2T	253.983	9.9993	253.951	9.9981	49L	19L
									52T	21T					8T	3T

General Recommended Housing Bore Limits for Metric Bearings—ISO H6 and N6

Bearing Outside Diameter				Housing Stationary								Housing Rotating							
Max		Min		Housing Bore (H6)				Fit		Housing Bore (N6)				Fit					
mm		mm		Max	Min			.001	.0001	Max	Min			.001	.0001				
mm	in	mm	in	mm	in	mm	in	mm	in	mm	in	mm	in	mm	in				
16	16	0.6299	15.993	0.6296	16.011	0.6303	16	0.6299	18L 0	7L 0	15.993	0.6295	15.980	0.6291	0 20T	1T 8T			
19	19	0.7480	18.992	0.7477	19.013	0.7485	19	0.7480			18.989	0.7476	18.976	0.7471					
21	21	0.8268	20.992	0.8265	21.013	0.8273	21	0.8268			20.989	0.8264	20.976	0.8259					
22	22	0.8661	21.992	0.8658	22.013	0.8666	22	0.8661			21.989	0.8657	21.976	0.8652					
24	24	0.9449	23.992	0.9446	24.013	0.9454	24	0.9449	21L 0	8L 0	23.989	0.9445	23.976	0.9440	3T	1T			
26	26	1.0236	25.992	1.0233	26.013	1.0241	26	1.0236			25.989	1.0232	25.976	1.0227	24T	9T			
28	28	1.1024	27.992	1.1021	28.013	1.1029	28	1.1024			27.989	1.1020	27.976	1.1015					
30	30	1.1811	29.992	1.1808	30.013	1.1816	30	1.1811			29.989	1.1807	29.976	1.1802					
32	32	1.2598	31.991	1.2594	32.016	1.2604	32	1.2598			31.988	1.2593	31.972	1.2587					
35	35	1.3780	34.991	1.3776	35.016	1.3786	35	1.3780			34.988	1.3775	34.972	1.3769					
37	37	1.4567	36.991	1.4563	37.016	1.4573	37	1.4567	25L 0	10L 0	36.988	1.4562	36.972	1.4556	3T	1T			
40	40	1.5748	39.991	1.5744	40.016	1.5754	40	1.5748			39.988	1.5743	39.972	1.5737	28T	11T			
42	42	1.6535	41.991	1.6531	42.016	1.6541	42	1.6535			41.988	1.6530	41.972	1.6524					
47	47	1.8504	46.991	1.8500	47.016	1.8510	47	1.8504			46.988	1.8499	46.972	1.8493					
52	52	2.0472	51.989	2.0468	52.019	2.0479	52	2.0472			51.986	2.0466	51.967	2.0459					
55	55	2.1654	54.989	2.1650	55.019	2.1661	55	2.1654			54.986	2.1648	54.967	2.1641					
58	58	2.2835	57.989	2.2831	58.019	2.2842	58	2.2835			57.986	2.2829	57.967	2.2822					
62	62	2.4409	61.989	2.4405	62.019	2.4416	62	2.4409			61.986	2.4403	61.967	2.4396					
65	65	2.5591	64.989	2.5587	65.019	2.5598	65	2.5591	30L 0	11L 0	64.986	2.5585	64.967	2.5578	3T	2T			
68	68	2.6772	67.989	2.6768	68.019	2.6779	68	2.6772			67.986	2.6766	67.967	2.6759	33T	13T			
70	70	2.7559	69.989	2.7555	70.019	2.7566	70	2.7559			69.986	2.7553	69.967	2.7546					
72	72	2.8346	71.989	2.8342	72.019	2.8353	72	2.8346			71.986	2.8340	71.967	2.8333					
75	75	2.9528	74.989	2.9524	75.019	2.9535	75	2.9528			74.986	2.9522	74.967	2.9515					
78	78	3.0709	77.989	3.0705	78.019	3.0716	78	3.0709			77.986	3.0703	77.967	3.0696					
80	80	3.1496	79.989	3.1492	80.019	3.1503	80	3.1496			79.986	3.1490	79.967	3.1483					
85	85	3.3465	84.987	3.3460	85.022	3.3474	85	3.3465			84.984	3.3459	84.962	3.3450					
90	90	3.5433	89.987	3.5428	90.022	3.5442	90	3.5433			89.984	3.5427	89.962	3.5418					
95	95	3.7402	94.987	3.7397	95.022	3.7411	95	3.7402			94.984	3.7396	94.962	3.7387					
100	100	3.9370	99.987	3.9365	100.022	3.9379	100	3.9370	35L 0	14L 0	99.984	3.9364	99.962	3.9355	3T	1T			
105	105	4.1339	104.987	4.1334	105.022	4.1348	105	4.1339			104.984	4.1333	104.962	4.1324	38T	15T			
110	110	4.3307	109.987	4.3302	110.022	4.3316	110	4.3307			109.984	4.3301	109.962	4.3292					
115	115	4.5276	114.987	4.5271	115.022	4.5285	115	4.5276			114.984	4.5270	114.962	4.5261					
120	120	4.7244	119.987	4.7239	120.022	4.7253	120	4.7244			119.984	4.7238	119.962	4.7229					
125	125	4.9213	124.985	4.9207	125.025	4.9223	125	4.9213			124.980	4.9205	124.955	4.9195					
130	130	5.1181	129.985	5.1175	130.025	5.1191	130	5.1181			129.980	5.1173	129.955	5.1163					
135	135	5.3150	134.985	5.3144	135.025	5.3160	135	5.3150	40L 0	16L 0	134.980	5.3142	134.955	5.3132	5T	2T			
140	140	5.5118	139.985	5.5112	140.025	5.5128	140	5.5118			139.980	5.5110	139.955	5.5100	45T	18T			
145	145	5.7087	144.985	5.7081	145.025	5.7097	145	5.7087			144.980	5.7079	144.955	5.7069					
150	150	5.9055	149.985	5.9049	150.025	5.9065	150	5.9055			149.980	5.9047	149.955	5.9037					
160	160	6.2992	159.982	6.2985	160.025	6.3002	160	6.2992			159.980	6.2984	159.955	6.2973					
165	165	6.4961	164.982	6.4954	165.025	6.4971	165	6.4961			164.980	6.4953	164.955	6.4942					
170	170	6.6929	169.982	6.6922	170.025	6.6939	170	6.6929	43L 0	17L 0	169.980	6.6921	169.955	6.6910	2T	1T			
175	175	6.8898	174.982	6.8891	175.025	6.8908	175	6.8898			174.980	6.8890	174.955	6.8879	45T	19T			
180	180	7.0866	179.982	7.0859	180.025	7.0876	180	7.0866			179.980	7.0858	179.955	7.0847					
190	190	7.4803	189.980	7.4795	190.029	7.4814	190	7.4803			189.978	7.4794	189.949	7.4783					
200	200	7.8740	199.980	7.8732	200.029	7.8751	200	7.8740			199.978	7.8731	199.949	7.8720					
205	205	8.0709	204.980	8.0701	205.029	8.0720	205	8.0709			204.978	8.0700	204.949	8.0689					
210	210	8.2677	209.980	8.2669	210.029	8.2688	210	8.2677			209.978	8.2668	209.949	8.2657					
215	215	8.4646	214.980	8.4638	215.029	8.4657	215	8.4646	49L 0	19L 0	214.978	8.4637	214.949	8.4626	2T	1T			
220	220	8.6614	219.980	8.6606	220.029	8.6625	220	8.6614			219.978	8.6605	219.949	8.6594	51T	20T			
225	225	8.8583	224.980	8.8575	225.029	8.8594	225	8.8583			224.978	8.8574	224.949	8.8563					
230	230	9.0551	229.980	9.0543	230.029	9.0562	230	9.0551			229.978	9.0542	229.949	9.0531					
235	235	9.2520	234.980	9.2512	235.029	9.2531	235	9.2520			234.978	9.2511	234.949	9.2500					
240	240	9.4488	239.980	9.4480	240.029	9.4499	240	9.4488			239.978	9.4479	239.949	9.4468					
250	250	9.8425	249.980	9.8417	250.029	9.8436	250	9.8425			249.978	9.8416	249.949	9.8405					
260	260	10.2362	259.975	10.2352	260.032	10.2375	260	10.2362			259.975	10.2352	259.943	10.2340					
265	265	10.4331	264.975	10.4321	265.032	10.4344	265	10.4331			264.975	10.4321	264.943	10.4309					
270	270	10.6299	269.975	10.6289	270.032	10.6312	270	10.6299			269.975	10.6289	269.943	10.6277					
280	280	11.0236	279.975	11.0226	280.032	11.0249	280	11.0236	57L 0	23L 0	279.975	11.0226	279.943	11.0214	0	0			
290	290	11.4173	289.975	11.4163	290.032	11.4186	290	11.4173			289.975	11.4163	289.943	11.4151	57T	22T			
300	300	11.8110	299.975	11.8100	300.032	11.8123	300	11.8110			299.975	11.8100	299.943	11.8088					
310	310	12.2047	309.975	12.2037	310.032	12.2060	310	12.2047			309.975	12.2037	309.943	12.2025					
320	320	12.5984	319.972	12.5973	320.036	12.5998	320	12.5984			319.974	12.5974	319.938	12.5958					
340	340	13.3858	339.972	13.3847	340.036	13.3872	340	13.3858			339.974	13.3848	339.938	13.3832					
350	350	13.7795	349.972	13.7784	350.036	13.7809	350	13.7809	64L	25L	349.974	13.7785	349.938	13.7769	2L	1L			
360	360	14.1732	359.972	14.1721	360.036	14.1746	360	14.1732			359.974	14.1722	359.938	14.1706					
370	370	14.5669	369.972	14.5658	370.036	14.5683	370	14.5669	0	0	369.974	14.5659	369.938	14.5643	62T	26T			
380	380	14.9606	379.972	14.9595	380.036	14.9620	380	14.9606			379.974	14.9596	379.938	14.9580					
390	390	15.3543	389.972	15.3532	390.036	15.3557	390	15.3543			389.974	15.3533	389.938	15.3517					
400	400	15.7480	399.972	15.7469	400.036	15.7494	400	15.7480			399.974	15.7470	399.938	15.7454					
410	410	16.1417	409.967	16.1404	410.040	16.1433	410	16.1417			409.973	16.1406	409.933	16.1391					
420	420	16.5354	419.967	16.5341	420.040	16.5370	420	16.5354			419.973	16.5343	419.933	16.5328					
430	430	16.9291	429.967	16.9278	430.040	16.9307	430	16.9291			429.973	16.9280	429.933	16.9265					
440	440	17.3228	439.967	17.321															

General Recommended Housing Bore Limits for Inch-Size Bearings—ISO H6 and N6

mm	Bearing Outside Diameter				Housing Stationary						Housing Rotating					
	Max		Min		Housing Bore (H6)				Fit		Housing Bore (N6)				Fit	
					Max		Min				Max		Min			
	mm	in	mm	in	mm	in	mm	in	.001 mm	.0001 in	mm	in	mm	in	.001 mm	.0001 in
R2	9.525	0.3750	9.518	0.3747	9.536	0.3754	9.525	0.3750			9.518	0.3746	9.505	0.3742		
R2A	12.700	0.5000	12.693	0.4997	12.711	0.5004	12.700	0.5000	18L	7L	12.693	0.4996	12.680	0.4992	0	1T
R3	12.700	0.5000	12.693	0.4997	12.711	0.5004	12.700	0.5000	0	0	12.693	0.4996	12.680	0.4992	20T	8T
R4	15.875	0.6250	15.868	0.6247	15.886	0.6254	15.875	0.6250			15.868	0.6246	15.855	0.6242		
R4A	19.050	0.7500	19.042	0.7497	19.063	0.7505	19.050	0.7500			19.039	0.7496	19.026	0.7491		
R6	22.225	0.8750	22.217	0.8747	22.238	0.8755	22.225	0.8750	21L	8L	22.214	0.8746	22.201	0.8741	3T	1T
R8	28.575	1.1250	28.567	1.1247	28.588	1.1255	28.575	1.1250	0	0	28.564	1.1246	28.551	1.1241	24T	9T
R10	34.925	1.3750	34.916	1.3746	34.941	1.3756	34.925	1.3750	25L	10L	34.913	1.3745	34.897	1.3739	3T	1T
R12	41.275	1.6250	41.266	1.6246	41.291	1.6256	41.275	1.6250	0	0	41.263	1.6245	41.247	1.6239	28T	11T
R14	47.625	1.8750	47.616	1.8746	47.641	1.8756	47.625	1.8750			47.613	1.8745	47.597	1.8739		
R16	50.800	2.0000	50.789	1.9996	50.819	2.0007	50.800	2.0000			50.786	1.9994	50.767	1.9987		
R18	53.975	2.1250	53.964	2.1246	53.994	2.1257	53.975	2.1250			53.961	2.1244	53.942	2.1237		
R20	57.150	2.2500	57.139	2.2496	57.169	2.2507	57.150	2.2500			57.136	2.2494	57.117	2.2487		
R24	66.675	2.6250	66.664	2.6246	66.694	2.6257	66.675	2.6250			66.661	2.6244	66.642	2.6237		
XLS1½	65.088	2.5625	65.077	2.5621	65.107	2.5632	65.088	2.5625	30L	11L	65.074	2.5619	65.055	2.5612	3T	2T
XLS1½	68.263	2.6875	68.252	2.6871	68.282	2.6882	68.263	2.6875	0	0	68.249	2.6869	68.230	2.6862		
XLS1½	73.025	2.8750	73.014	2.8746	73.044	2.8757	73.025	2.8750			73.011	2.8744	72.992	2.8737		
XLS1¾	76.200	3.0000	76.189	2.9996	76.219	3.0007	76.200	3.0000			76.186	2.9994	76.167	2.9987		
XLS1¾	80.963	3.1875	80.950	3.1870	80.985	3.1884	80.963	3.1875			80.947	3.1869	80.925	3.1860		
XLS2	84.138	3.3125	84.125	3.3120	84.160	3.3134	84.138	3.3125			84.122	3.3119	84.100	3.3110		
XLS2½	87.313	3.4375	87.300	3.4370	87.335	3.4384	87.313	3.4375	35L	14L	87.297	3.4369	87.275	3.4360	3T	1T
XLS2¼	90.488	3.5625	90.475	3.5620	90.510	3.5634	90.488	3.5625	0	0	90.472	3.5619	90.450	3.5610	38T	15T
XLS2½	98.425	3.8750	98.412	3.8745	98.447	3.8759	98.425	3.8750			98.409	3.8744	98.387	3.8735		
XLS2¾	104.775	4.1250	104.762	4.1245	104.997	4.1259	104.775	4.1250			104.759	4.1244	104.737	4.1235		
XLS2¾	104.775	4.1250	104.762	4.1245	104.997	4.1259	104.775	4.1250			104.759	4.1244	104.737	4.1235		
XLS3	114.300	4.5000	114.287	4.4995	114.322	4.5009	114.300	4.5000			114.284	4.4994	114.262	4.4985		
XLS3¼	120.650	4.7500	120.635	4.7494	120.675	4.7510	120.650	4.7500	40L	16L	120.630	4.7492	120.605	4.7482	5T	2T
XLS3½	127.000	5.0000	126.985	4.9994	127.025	5.0010	127.000	5.0000	0	0	126.980	4.9992	126.955	4.9982	45T	18T
XLS3¾	133.350	5.2500	133.335	5.2494	133.375	5.2510	133.350	5.2500			133.330	5.2492	133.305	5.2482		
XLS4¼	152.400	6.0000	152.382	5.9993	152.425	6.0010	152.400	6.0000			152.380	5.9992	152.355	5.9981		
XLS4½	158.750	6.2500	158.732	6.2493	158.775	6.2510	158.750	6.2500	43L	17L	158.730	6.2492	158.704	6.2481	2T	1T
XLS4¾	165.100	6.5000	165.082	6.4993	165.125	6.5010	165.100	6.5000	0	0	165.080	6.4992	165.055	6.4981	45T	19T
XLS5	177.800	7.0000	177.782	6.9993	177.825	7.0010	177.800	7.0000			177.780	6.9992	177.755	6.9981		
XLS5½	190.500	7.5000	190.480	7.4992	190.529	7.5011	190.500	7.5000			190.478	7.4991	190.449	7.4980		
XLS6	203.200	8.0000	203.180	7.9992	203.229	8.0011	203.200	8.0000			203.178	7.9991	203.149	7.9980		
XLS6¼	215.900	8.5000	215.880	8.4992	215.929	8.5011	215.900	8.5000	49L	19L	215.878	8.4991	215.849	8.4980	2T	1T
XLS6½	222.250	8.7500	222.230	8.7492	222.279	8.7511	222.250	8.7500	0	0	222.228	8.7491	222.199	8.7480	51T	20T
XLS7	241.300	9.5000	241.280	9.4992	241.329	9.5011	241.300	9.5000			241.278	9.4991	241.249	9.4980		
XLS7¼	247.650	9.7500	247.630	9.7492	247.679	9.7511	247.650	9.7500			247.628	9.7492	247.599	9.7480		
XLS7¾	266.700	10.5000	266.675	10.4990	266.732	10.5013	266.700	10.5000			266.675	10.4990	266.643	10.4978		
XLS8	273.051	10.7500	273.026	10.7490	273.083	10.7513	273.051	10.7500	57L	23L	273.026	10.7490	272.994	10.7478	0	0
XLS8¼	279.401	11.0000	279.376	10.9990	279.433	11.0013	279.401	11.0000	0	0	279.376	10.9990	279.334	10.9978	57T	22T
XLS8½	292.101	11.5000	292.076	11.4990	292.133	11.5013	292.101	11.5000			292.076	11.4990	292.044	11.4978		
XLS9	304.801	12.0000	304.776	11.9990	304.833	12.0013	304.801	12.0000			304.776	11.9990	304.744	11.9978		
XLS10	336.551	13.2500	336.523	13.2489	336.587	13.2514	336.551	13.2500	64L	25L	336.525	13.2490	336.489	13.2474	2L	1L
									0	0					62T	26T

For aluminum or other soft metal housings make bore limits same as bearing O.D. limits.

Bearing Bore Diameter				Shaft Rotating						
Max		Min		Shaft Diameter				Fit		
mm		mm		Max		Min		.001	.0001	
mm	in	mm	in	mm	in	mm	in	mm	in	
4	4	0.1575	3.995	0.1573	4.005	0.1577	4	0.1575	0	0
5	5	0.1969	4.995	0.1967	5.005	0.1971	5	0.1969	10T	4T
6	6	0.2362	5.995	0.2360	6.005	0.2364	6	0.2362		
7	7	0.2756	6.995	0.2754	7.005	0.2758	7	0.2756		
8	8	0.3150	7.995	0.3148	8.005	0.3152	8	0.3150	0	0
9	9	0.3543	8.995	0.3541	9.005	0.3545	9	0.3543	10T	4T
10	10	0.3937	9.995	0.3935	10.005	0.3939	10	0.3937		
12	12	0.4724	11.995	0.4722	12.005	0.4726	12	0.4724	0	0
15	15	0.5906	14.995	0.5904	15.005	0.5908	15	0.5906	10T	4T
17	17	0.6693	16.995	0.6691	17.005	0.6695	17	0.6693		
20	20	0.7874	19.994	0.7872	20.005	0.7876	20	0.7874	0	0
25	25	0.9843	24.994	0.9841	25.005	0.9845	25	0.9843	11T	4T
30	30	1.1811	29.994	1.1809	30.005	1.1813	30	1.1811		
35	35	1.3780	34.992	1.3777	35.005	1.3782	35	1.3780		
40	40	1.5748	39.992	1.5745	40.005	1.5750	40	1.5748	0	0
45	45	1.7717	44.992	1.7714	45.005	1.7719	45	1.7717	13T	5T
50	50	1.9685	49.992	1.9682	50.005	1.9687	50	1.9685		
55	55	2.1654	54.991	2.1650	55.008	2.1657	55	2.1654		
60	60	2.3622	59.991	2.3618	60.008	2.3625	60	2.3622		
65	65	2.5591	64.991	2.5587	65.008	2.5594	65	2.5591	0	0
70	70	2.7559	69.991	2.7555	70.008	2.7562	70	2.7559	17T	7T
75	75	2.9528	74.991	2.9524	75.008	2.9531	75	2.9528		
80	80	3.1496	79.991	3.1492	80.008	3.1499	80	3.1496		
85	85	3.3465	84.990	3.3461	85.008	3.3468	85	3.3465		
90	90	3.5433	89.990	3.5429	90.008	3.5436	90	3.5433		
95	95	3.7402	94.990	3.7398	95.008	3.7405	95	3.7402	0	0
100	100	3.9370	99.990	3.9366	100.008	3.9373	100	3.9370	18T	7T
105	105	4.1339	104.990	4.1335	105.008	4.1342	105	4.1339		
110	110	4.3307	109.990	4.3303	110.008	4.3310	110	4.3307		
115	115	4.5276	114.990	4.5272	115.008	4.5279	115	4.5276		
120	120	4.7244	119.990	4.7240	120.008	4.7247	120	4.7244		
125	125	4.9213	124.987	4.9208	125.010	4.9217	125	4.9213		
130	130	5.1181	129.987	5.1176	130.010	5.1185	130	5.1181		
140	140	5.5118	139.987	5.5113	140.010	5.5122	140	5.5118	0	0
150	150	5.9055	149.987	5.9050	150.010	5.9059	150	5.9055	23T	9T
160	160	6.2992	159.987	6.2987	160.010	6.2996	160	6.2992		
170	170	6.6929	169.987	6.6924	170.010	6.6933	170	6.6929		
180	180	7.0866	179.987	7.0861	180.010	7.0870	180	7.0866		
190	190	7.4803	189.985	7.4797	190.013	7.4808	190	7.4803		
200	200	7.8740	199.985	7.8734	200.013	7.8745	200	7.8740		
210	210	8.2677	209.985	8.2671	210.013	8.2682	210	8.2677	0	0
220	220	8.6614	219.985	8.6608	220.013	8.6619	220	8.6614	28T	11T
230	230	9.0551	229.985	9.0545	230.013	9.0556	230	9.0551		
240	240	9.4488	239.985	9.4482	240.013	9.4493	240	9.4488		
250	250	9.8425	249.985	9.8419	250.013	9.8430	250	9.8425		
260	260	10.2362	259.982	10.2355	260.013	10.2367	260	10.2362	0	0
280	280	11.0236	279.982	11.0229	280.013	11.0241	280	11.0236	31T	12T
300	300	11.8110	299.982	11.8103	300.013	11.8115	300	11.8110		
320	320	12.5984	319.977	12.5975	320.014	12.5990	320	12.5984	0	0
									37T	15T

Bearing Bore Diameter				Shaft Rotating						
Max		Min		Shaft Diameter				Fit		
mm		mm		Max		Min		.001	.0001	
mm	in	mm	in	mm	in	mm	in	mm	in	
R2	3.175	0.1250	3.170	0.1248	3.180	0.1252	3.175	0.1250		
R2A	3.175	0.1250	3.170	0.1248	3.180	0.1252	3.175	0.1250	0	0
R3	4.763	0.1875	4.758	0.1873	4.767	0.1877	4.763	0.1875	10T	4T
R4	6.350	0.2500	6.345	0.2498	6.355	0.2502	6.350	0.2500		
R4A	6.350	0.2500	6.345	0.2498	6.355	0.2502	6.350	0.2500		
R6	9.525	0.3750	9.520	0.3748	9.580	0.3752	9.525	0.3750		
R8	12.700	0.5000	12.695	0.4998	12.705	0.5002	12.700	0.5000	0	0
R10	15.875	0.6250	15.870	0.6248	15.880	0.6252	15.875	0.6250	10T	4T
R12	19.050	0.7500	19.044	0.7498	19.055	0.7502	19.050	0.7500		
R14	22.225	0.8750	22.219	0.8748	22.230	0.8752	22.225	0.8750	0	0
R16	25.400	1.0000	25.394	0.9998	25.405	1.0002	25.400	1.0000	11T	4T
R18	28.575	1.1250	28.569	1.1248	28.580	1.1252	28.575	1.1250		
R20	31.750	1.2500	31.742	1.2497	31.755	1.2502	31.750	1.2500		
R24	38.100	1.5000	38.092	1.4997	38.105	1.5002	38.100	1.5000		
XLS1¾	34.925	1.3750	34.917	1.3747	34.930	1.3752	34.925	1.3750	0	0
XLS1½	38.100	1.5000	38.092	1.4997	38.105	1.5002	38.100	1.5000	13T	5T
XLS1¼	41.275	1.6250	41.267	1.6247	41.280	1.6252	41.275	1.6250		
XLS1⅓	44.450	1.7500	44.442	1.7497	44.455	1.7502	44.450	1.7500		
XLS1⅒	47.625	1.8750	47.617	1.8747	47.630	1.8752	47.625	1.8750		
XLS2	50.800	2.0000	50.791	1.9996	50.808	2.0003	50.800	2.0000		
XLS2½	53.975	2.1250	53.966	2.1246	53.983	2.1253	53.975	2.1250		
XLS2¼	57.150	2.2500	57.141	2.2496	57.158	2.2503	57.150	2.2500	0	0
XLS2½	63.500	2.5000	63.491	2.4996	63.508	2.5003	63.500	2.5000	17T	7T
XLS2⅓	66.675	2.6250	66.666	2.6246	66.683	2.6253	66.675	2.6250		
XLS2⅒	69.850	2.7500	69.841	2.7496	69.858	2.7503	69.850	2.7500		
XLS3	76.200	3.0000	76.191	2.9996	76.208	3.0003	76.200	3.0000		
XLS3¼	82.550	3.2500	82.540	3.2496	82.558	3.2503	82.550	3.2500		
XLS3½	88.900	3.5000	88.890	3.4996	88.908	3.5003	88.900	3.5000	0	0
XLS3¾	95.250	3.7500	95.240	3.7496	95.258	3.7503	95.250	3.7500	18T	7T
XLS4¼	107.950	4.2500	107.940	4.2496	107.958	4.2503	107.950	4.2500		
XLS4½	114.300	4.5000	114.290	4.4996	114.808	4.5003	114.300	4.5000		
XLS4¾	120.650	4.7500	120.637	4.7495	120.660	4.7504	120.650	4.7500		
XLS5	127.000	5.0000	126.987	4.9995	127.010	5.0004	127.000	5.0000		
XLS5½	139.700	5.5000	139.687	5.4995	139.710	5.5004	139.700	5.5000	0	0
XLS6	152.400	6.0000	152.387	5.9995	152.410	6.0004	152.400	6.0000	23T	9T
XLS6¼	158.750	6.2500	158.737	6.2495	158.760	6.2504	158.750	6.2500		
XLS6½	165.100	6.5000	165.087	6.4995	165.110	6.5004	165.100	6.5000		
XLS7	177.800	7.0000	177.787	6.9995	177.810	7.0004	177.800	7.0000		
XLS7¼	184.150	7.2500	184.135	7.2494	184.163	7.2505	184.150	7.2500		
XLS7½	196.850	7.7500	196.835	7.7494	196.863	7.7505	196.850	7.7500		
XLS8	203.200	8.0000	203.185	7.9994	203.213	8.0005	203.200	8.0000	0	0
XLS8¼	209.950	8.2500	209.935	8.2494	209.963	8.2505	209.950	8.2500	28T	11T
XLS8½	215.900	8.5000	215.885	8.4994	215.913	8.5005	215.900	8.5000		
XLS9	228.600	9.0000	228.585	8.9994	228.613	9.0005	228.600	9.0000		
XLS10	254.000	10.0000	253.982	9.9993	254.013	10.0005	254.000	10.0000	0	0
									31T	12T

Bearing Outside Diameter				Housing Stationary							
mm		Max	Min	Housing Bore			Fit				
mm	in	mm	in	mm	in	mm	in	.001	.0001		
16	16	0.6299	15.995	0.6297	16.008	0.6302	16	0.6299	13L	5L	
19	19	0.7480	18.994	0.7478	19.008	0.7483	19	0.7480			
21	21	0.8268	20.994	0.8266	21.008	0.8271	21	0.8268			
22	22	0.8661	21.994	0.8659	22.008	0.8664	22	0.8661	14L	5L	
24	24	0.9449	23.994	0.9447	24.008	0.9452	24	0.9449	0	0	
26	26	1.0236	25.994	1.0234	26.008	1.0239	26	1.0236			
28	28	1.1024	27.994	1.1022	28.008	1.1027	28	1.1024			
30	30	1.1811	29.994	1.1809	30.008	1.1814	30	1.1811			
32	32	1.2598	31.993	1.2595	32.008	1.2601	32	1.2598			
35	35	1.3780	34.993	1.3777	35.008	1.3783	35	1.3780			
37	37	1.4567	36.993	1.4564	37.008	1.4570	37	1.4567	15L	6L	
40	40	1.5748	39.993	1.5745	40.008	1.5751	40	1.5748	0	0	
42	42	1.6535	41.993	1.6532	42.008	1.6538	42	1.6535			
47	47	1.8504	46.993	1.8501	47.008	1.8507	47	1.8504			
52	52	2.0472	51.991	2.0468	52.008	2.0475	52	2.0472			
55	55	2.1654	54.991	2.1650	55.008	2.1657	55	2.1654			
58	58	2.2835	57.991	2.2831	58.008	2.2838	58	2.2835			
62	62	2.4409	61.991	2.4405	62.008	2.4412	62	2.4409			
65	65	2.5591	64.991	2.5587	65.008	2.5594	65	2.5591	17L	7L	
68	68	2.6772	67.991	2.6768	68.008	2.6775	68	2.6772	0	0	
70	70	2.7559	69.991	2.7555	70.008	2.7562	70	2.7559			
72	72	2.8346	71.991	2.8342	72.008	2.8349	72	2.8346			
75	75	2.9528	74.991	2.9524	75.008	2.9531	75	2.9528			
78	78	3.0709	77.991	3.0705	78.008	3.0712	78	3.0709			
80	80	3.1496	79.991	3.1492	80.008	3.1499	80	3.1496			
85	85	3.3465	84.990	3.3461	85.010	3.3469	85	3.3465			
90	90	3.5433	89.990	3.5429	90.010	3.5437	90	3.5433			
95	95	3.7402	94.990	3.7398	95.010	3.7406	95	3.7402			
100	100	3.9370	99.990	3.9366	100.010	3.9374	100	3.9370	20L	8L	
105	105	4.1339	104.990	4.1335	105.010	4.1343	105	4.1339	0	0	
110	110	4.3307	109.990	4.3303	110.010	4.3311	110	4.3307			
115	115	4.5276	114.990	4.5272	115.010	4.5280	115	4.5276			
120	120	4.7244	119.990	4.7240	120.010	4.7248	120	4.7244			
125	125	4.9213	124.989	4.9209	125.013	4.9218	125	4.9213			
130	130	5.1181	129.989	5.1177	130.013	5.1186	130	5.1181			
135	135	5.3150	134.989	5.3146	135.013	5.3155	135	5.3150	24L	9L	
140	140	5.5118	139.989	5.5114	140.013	5.5123	140	5.5118	0	0	
145	145	5.7087	144.989	5.7083	145.013	5.7092	145	5.7087			
150	150	5.9055	149.989	5.9051	150.013	5.9060	150	5.9055			
160	160	6.2992	159.987	6.2987	160.013	6.2997	160	6.2992			
165	165	6.4961	164.987	6.4956	165.013	6.4966	165	6.4961	26L	10L	
170	170	6.6929	169.987	6.6924	170.013	6.6934	170	6.6929	0	0	
175	175	6.8898	174.987	6.8893	175.013	6.8903	175	6.8898			
180	180	7.0866	179.987	7.0861	180.013	7.0871	180	7.0866			
190	190	7.4803	189.985	7.4797	190.015	7.4809	190	7.4803			
200	200	7.8740	199.985	7.8734	200.015	7.8746	200	7.8740			
205	205	8.0709	204.985	8.0703	205.015	8.0715	205	8.0709			
210	210	8.2677	209.985	8.2671	210.015	8.2683	210	8.2677			
215	215	8.4646	214.985	8.4640	215.015	8.4652	215	8.4646	30L	12L	
220	220	8.6614	219.985	8.6608	220.015	8.6620	220	8.6614	0	0	
225	225	8.8583	224.985	8.8577	225.015	8.8589	225	8.8583			
230	230	9.0551	229.985	9.0545	230.015	9.0557	230	9.0551			
235	235	9.2520	234.985	9.2514	235.015	9.2526	235	9.2520			
240	240	9.4488	239.985	9.4482	240.015	9.4494	240	9.4488			
250	250	9.8425	249.985	9.8419	250.015	9.8431	250	9.8425			
260	260	10.2362	259.982	10.2355	260.015	10.2368	260	10.2362			
265	265	10.4331	264.982	10.4324	265.015	10.4337	265	10.4331			
270	270	10.6299	269.982	10.6292	270.015	10.6302	270	10.6299			
280	280	11.0236	279.982	11.0229	280.015	11.0242	280	11.0236	33L	13L	
290	290	11.4173	289.982	11.4166	290.015	11.4179	290	11.4173	0	0	
300	300	11.8110	299.982	11.8103	300.015	11.8116	300	11.8110			
310	310	12.2047	309.982	12.2040	310.015	12.2053	310	12.2047			
320	320	12.5984	319.980	12.5976	320.018	12.5991	320	12.5984			
340	340	13.3858	339.980	13.3850	340.018	13.3865	340	13.3858			
350	350	13.7795	349.980	13.7787	350.018	13.7802	350	13.7795			
360	360	14.1732	359.980	14.1724	360.018	14.1739	360	14.1732	38L	15L	
370	370	14.5669	369.980	14.5661	370.018	14.5676	370	14.5669	0	0	
380	380	14.9606	379.980	14.9598	380.018	14.9613	380	14.9606			
390	390	15.3543	389.980	15.3535	390.018	15.3550	390	15.3543			
400	400	15.7480	399.980	15.7472	400.018	15.7487	400	15.7480			
410	410	16.1417	409.977	16.1408	410.020	16.1425	410	16.1417			
420	420	16.5354	419.977	16.5345	420.020	16.5362	420	16.5354			
430	430	16.9291	429.977	16.9282	430.020	16.9299	430	16.9291	43L	17L	
440	440	17.3228	439.977	17.3219	440.020	17.3236	440	17.3228	0	0	
460	460	18.1102	459.977	18.1093	460.020	18.1110	460	18.1102			
480	480	18.8976	479.977	18.8967	480.020	18.8984	480	18.8976			
500	500	19.6850	499.977	19.6841	500.020	19.6858	500	19.6850			
520	520	20.4724	519.972	20.4713	520.025	20.4734	520	20.4724			
540	540	21.2598	539.972	21.2587	540.025	21.2608	540	21.2598			
560	560	22.0472	559.972	22.0461	560.025	22.0482	560	22.0472	53L	21L	
580	580	22.8346	579.972	22.8335	580.025	22.8356	580	22.8346	0	0	
600	600	23.6220	599.972	23.6209	600.025	23.6230	600	23.6220			
620	620	24.4094	619.972	24.4083	620.025	24.4104	620	24.4094			

Bearing Outside Diameter				Housing Stationary							
mm		Max	Min	Housing Bore			Fit				
mm	in	mm	in	mm	in	mm	in	.001	.0001		
R2	9.525	0.3750	9.520	0.3748	9.533	0.3753	9.525	0.3750			
R2A	12.700	0.5000	12.695	0.4998	12.708	0.5003	12.700	0.5000	13L	5L	
R3	12.708	0.5000	12.695	0.4998	12.700	0.5003	12.700	0.5000	0	0	
R4	15.875	0.6250	15.870	0.6248	15.883	0.6253	15.875	0.6250			
R4A	19.050	0.7500	19.044	0.7498	19.058	0.7503	19.050	0.7500	14L	5L	
R6	22.225	0.8750	22.219	0.8748	22.283	0.8753	22.225	0.8750	0	0	
R8	28.575	1.1250	28.569	1.1248	28.583	1.1253	28.575	1.1250			
R10	34.925	1.3750	34.918	1.3747	34.933	1.3753	34.925	1.3750	15L	6L	
R12	41.275	1.6250	41.268	1.6247	41.283	1.6253	41.275	1.6250	0	0	
R14	47.625	1.8750	47.618	1.8747	47.633	1.8753	47.625	1.8750			
R16	50.800	2.0000	50.791	1.9996	50.808	2.0003	50.800	2.0000			
R18	53.975	2.1250	53.966	2.1246	53.983	2.1253	53.975	2.1250			
R20	57.150	2.2500	57.141	2.2496	57.158	2.2503	57.150	2.2500	17L	7L	
R24	66.675	2.6250	66.666	2.6246	66.683	2.6253	66.675	2.6250	0	0	
XLS1%	65.088	2.5625	65.079	2.5621	65.096	2.5628	65.088	2.5625			
XLS1½	68.263	2.6875	68.254	2.6871	68.271	2.6878	68.263	2.6875			
XLS1¾	73.025	2.8750	73.016	2.8746	73.033	2.8753	73.025	2.8750			
XLS1¾	76.200	3.0000	76.191	2.9996	76.208	3.0003	76.200	3.0000			
XLS1¾	80.963	3.1875	80.953	3.1871	80.973	3.1879	80.963	3.1875			
XLS2	84.138	3.3125	84.128	3.3121	84.148	3.3129	84.138	3.3125			
XLS2½	87.313	3.4375	87.303	3.4371	87.323	3.4379	87.313	3.4375			
XLS2¾	90.488	3.5625	90.478	3.5621	90.498	3.5629	90.488	3.5625	20L	8L	
XLS2¾	98.425	3.8750	98.415	3.8746	98.435	3.8754	98.425	3.8750	0	0	
XLS2¾	104.775	4.1250	104.765	4.1246	104.785	4.1254	104.775	4.1250			
XLS3	104.775	4.1250	104.765	4.1246	104.785	4.1254	104.775	4.1250			
XLS3	114.300	4.5000	114.290	4.4996	114.310	4.5004	114.300	4.5000			
XLS3¼	120.650	4.7500	120.639	4.7496	120.663	4.7505	120.650	4.7500	24L	9L	

Bearing Bore Diameter				Shaft Rotating						
Max		Min		Shaft Diameter				Fit		
mm		mm		Max		Min		.001	.0001	
mm	in	mm	in	mm	in	mm	in	mm	in	
4	4	0.1575	3.996	0.15735	4.005	0.1577	4	0.1575	0	
5	5	0.1969	4.996	0.19675	5.005	0.1971	5	0.1969	9T	
6	6	0.2362	5.996	0.23605	6.005	0.2364	6	0.2362	3.5T	
7	7	0.2756	6.996	0.27545	7.005	0.2758	7	0.2756	0	
8	8	0.3150	7.996	0.31485	8.005	0.3152	8	0.3150	0	
9	9	0.3543	8.996	0.35415	9.005	0.3545	9	0.3543	9T	
10	10	0.3937	9.996	0.39355	10.005	0.3939	10	0.3937	3.5T	
12	12	0.4724	11.996	0.47225	12.005	0.4726	12	0.4724	0	
15	15	0.5906	14.996	0.59045	15.005	0.5908	15	0.5906	9T	
17	17	0.6693	16.996	0.66915	17.005	0.6695	17	0.6693	3.5T	
20	20	0.7874	19.995	0.7872	20.005	0.7876	20	0.7874	0	
25	25	0.9843	24.995	0.9841	25.005	0.9845	25	0.9843	10T	
30	30	1.1811	29.995	1.1809	30.005	1.1813	30	1.1811	4T	
35	35	1.3780	34.994	1.37775	35.005	1.3782	35	1.3780	0	
40	40	1.5748	39.994	1.57455	40.005	1.5750	40	1.5748	0	
45	45	1.7717	44.994	1.77145	45.005	1.7719	45	1.7717	11T	
50	50	1.9685	49.994	1.96825	50.005	1.9687	50	1.9685	4.5T	
55	55	2.1654	54.993	2.1651	55.008	2.1657	55	2.1654	0	
60	60	2.3622	59.993	2.3619	60.008	2.3625	60	2.3622	0	
65	65	2.5591	64.993	2.5588	65.008	2.5594	65	2.5591	0	
70	70	2.7559	69.993	2.7556	70.008	2.7562	70	2.7559	15T	
75	75	2.9528	74.993	2.9525	75.008	2.9531	75	2.9528	6T	
80	80	3.1496	79.993	3.1493	80.008	3.1499	80	3.1496	0	
85	85	3.3465	84.992	3.3462	85.008	3.3468	85	3.3465	0	
90	90	3.5433	89.992	3.5430	90.008	3.5436	90	3.5433	0	
95	95	3.7402	94.992	3.7399	95.008	3.7405	95	3.7402	0	
100	100	3.9370	99.992	3.9367	100.008	3.9373	100	3.9370	16T	
105	105	4.1339	104.992	4.1336	105.008	4.1342	105	4.1339	6T	
110	110	4.3307	109.992	4.3304	110.008	4.3310	110	4.3307	0	
115	115	4.5276	114.992	4.5273	115.008	4.5279	115	4.5276	0	
120	120	4.7244	119.992	4.7241	120.008	4.7247	120	4.7244	0	
125	125	4.9213	124.990	4.9209	125.010	4.9217	125	4.9213	0	
130	130	5.1181	129.990	5.1177	130.010	5.1185	130	5.1181	0	
140	140	5.5118	139.990	5.5114	140.010	5.5122	140	5.5118	0	
150	150	5.9055	149.990	5.9051	150.010	5.9059	150	5.9055	20T	
160	160	6.2992	159.990	6.2988	160.010	6.2996	160	6.2992	8T	
170	170	6.6929	169.990	6.6925	170.010	6.6933	170	6.6929	0	
180	180	7.0866	179.990	7.0862	180.010	7.0870	180	7.0866	0	
190	190	7.4803	189.988	7.47985	190.013	7.4808	190	7.4803	0	
200	200	7.8740	199.988	7.87355	200.013	7.8745	200	7.8740	0	
210	210	8.2677	209.988	8.26725	210.013	8.2682	210	8.2677	0	
220	220	8.6614	219.988	8.66095	220.018	8.6619	220	8.6614	25T	
230	230	9.0551	229.988	9.05465	230.013	9.0556	230	9.0551	9.5T	
240	240	9.4488	239.988	9.44835	240.013	9.4493	240	9.4488	0	
250	250	9.8425	249.988	9.84205	250.013	9.8430	250	9.8425	0	
260	260	10.2362	259.987	10.2357	260.013	10.2367	260	10.2362	0	
280	280	11.0236	279.987	11.0231	280.013	11.0241	280	11.0236	26T	
300	300	11.8110	299.987	11.8105	300.013	11.8115	300	11.8110	10T	

Bearing Bore Diameter				Shaft Rotating						
Max		Min		Shaft Diameter				Fit		
mm		mm		Max		Min		.001	.0001	
mm	in	mm	in	mm	in	mm	in	mm	in	
R2	3.175	0.1250	3.171	0.12485	3.180	0.1252	3.175	0.1250	0	
R2A	3.175	0.1250	3.171	0.12485	3.180	0.1252	3.175	0.1250	0	
R3	4.763	0.1875	4.759	0.18735	4.767	0.1877	4.763	0.1875	9T	
R4	6.350	0.2500	6.346	0.24985	6.355	0.2502	6.350	0.2500	3.5T	
RAA	6.350	0.2500	6.346	0.24985	6.355	0.2502	6.350	0.2500	0	
R6	9.525	0.3750	9.521	0.37485	9.530	0.3752	9.525	0.3750	0	
R8	12.700	0.5000	12.696	0.49985	12.705	0.5002	12.700	0.5000	9T	
R10	15.875	0.6250	15.871	0.62485	15.880	0.6252	15.875	0.6250	3.5T	
R12	19.050	0.7500	19.045	0.7498	19.055	0.7502	19.050	0.7500	0	
R14	22.225	0.8750	22.220	0.8748	22.230	0.8752	22.225	0.8750	0	
R16	25.400	1.0000	25.395	0.9998	25.405	1.0002	25.400	1.0000	10T	
R18	28.575	1.1250	28.570	1.1248	28.580	1.1252	28.575	1.1250	4T	
R20	31.750	1.2500	31.744	1.24975	31.755	1.2502	31.750	1.2500	0	
R24	38.100	1.5000	38.094	1.49975	38.105	1.5002	38.100	1.5000	0	
XLS1¾	34.925	1.3750	34.919	1.37475	34.930	1.3752	34.925	1.3750	0	
XLS1½	38.100	1.5000	38.094	1.49975	38.105	1.5002	38.100	1.5000	11T	
XLS1¼	41.275	1.6250	41.269	1.62475	41.280	1.6252	41.275	1.6250	4.5T	
XLS1⅓	44.450	1.7500	44.444	1.74975	44.455	1.7502	44.450	1.7500	0	
XLS1⅒	47.625	1.8750	47.619	1.87475	47.630	1.8752	47.625	1.8750	0	
XLS2	50.800	2.0000	50.793	1.9997	50.808	2.0003	50.800	2.0000	0	
XLS2¾	53.975	2.1250	53.968	2.1247	53.983	2.1253	53.975	2.1250	0	
XLS2½	57.150	2.2500	57.143	2.2497	57.158	2.2503	57.150	2.2500	0	
XLS2¼	60.325	2.3750	60.318	2.3747	60.333	2.3753	60.325	2.3750	0	
XLS2⅓	63.500	2.5000	63.493	2.4997	63.508	2.5003	63.500	2.5000	15T	
XLS2⅒	66.675	2.6250	66.668	2.6247	66.683	2.6253	66.675	2.6250	6T	
XLS2⅑	69.850	2.7500	69.843	2.7497	69.858	2.7503	69.850	2.7500	0	
XLS3	76.200	3.0000	76.193	2.9997	76.208	3.0003	76.200	3.0000	0	
XLS3¾	82.550	3.2500	82.542	3.2497	82.558	3.2503	82.550	3.2500	0	
XLS3½	88.900	3.5000	88.892	3.4997	88.908	3.5003	88.900	3.5000	0	
XLS3¼	95.250	3.7500	95.242	3.7497	95.258	3.7503	95.250	3.7500	16T	
XLS3⅓	101.600	4.0000	101.592	3.9997	101.608	4.0003	101.600	4.0000	6T	
XLS3⅒	107.950	4.2500	107.942	4.2497	107.958	4.2503	107.950	4.2500	0	
XLS3⅑	114.300	4.5000	114.292	4.4997	114.308	4.5003	114.300	4.5000	0	
XLS4¾	120.650	4.7500	120.640	4.7496	120.660	4.7504	120.650	4.7500	0	
XLS5	127.000	5.0000	126.990	4.9996	127.010	5.0004	127.000	5.0000	0	
XLS5½	139.700	5.5000	139.690	5.4996	139.710	5.5004	139.700	5.5000	0	
XLS5¼	152.400	6.0000	152.390	5.9996	152.410	6.0004	152.400	6.0000	20T	
XLS6	158.750	6.2500	158.740	6.2496	158.760	6.2504	158.750	6.2500	8T	
XLS6½	165.100	6.5000	165.090	6.4996	165.110	6.5004	165.100	6.5000	0	
XLS6¼	171.450	6.7500	171.440	6.7496	171.460	6.7504	171.450	6.7500	0	
XLS7	177.800	7.0000	177.790	6.9996	177.810	7.0004	177.800	7.0000	0	
XLS7¾	184.150	7.2500	184.138	7.24955	184.163	7.2505	184.150	7.2500	0	
XLS7½	196.850	7.7500	196.738	7.74955	196.863	7.7505	196.850	7.7500	0	
XLS7¼	203.200	8.0000	203.088	7.99955	203.213	8.0005	203.200	8.0000	25T	
XLS8	209.950	8.2500	209.938	8.24955	209.963	8.2505	209.950	8.2500	9.5T	
XLS8½	215.900	8.5000	215.888	8.49955	215.913	8.5005	215.900	8.5000	0	
XLS8¼	228.600	9.0000	228.588	8.99955	228.613	9.0005	228.600	9.0000	0	
XLS9	254.000	10.0000	253.987	9.9995	254.013	10.0005	254.000	10.0000	0	
XLS10	280.000	11.0000	279.987	10.9995	280.013	11.0005	280.000	11.0000	26T	
XLS11	306.000	12.0000	305.987	11.9995	306.013	12.0005	306.000	12.0000	10T	

Bearing Outside Diameter					Housing Stationary					
Max		Min			Housing Bore				Fit	
mm		mm			Max		Min		.001	.0001
mm	in	mm	in	mm	in	mm	in	mm	in	
16	16	0.6299	15.996	0.62975	16.008	0.6302	16	0.6299	12L	4.5L
19	19	0.7480	18.995	0.7478	19.008	0.7483	19	0.7480		
21	21	0.8268	20.995	0.8266	21.008	0.8271	21	0.8268		
22	22	0.8661	21.995	0.8659	22.008	0.8664	22	0.8661		
24	24	0.9449	23.995	0.9447	24.008	0.9432	24	0.9449	13L	5L
26	26	1.0236	25.995	1.0234	26.008	1.0239	26	1.0236	0	0
28	28	1.1024	27.995	1.1022	28.008	1.1027	28	1.1024		
30	30	1.1811	29.995	1.1809	30.008	1.1814	30	1.1811		
32	32	1.2598	31.994	1.25955	32.008	1.2601	32	1.2598		
35	35	1.3780	34.994	1.37775	35.008	1.3783	35	1.3780		
37	37	1.4567	36.994	1.45645	37.008	1.4570	37	1.4567	14L	5.5L
40	40	1.5748	39.994	1.57455	40.008	1.5751	40	1.5748	0	0
42	42	1.6535	41.994	1.65325	42.008	1.6538	42	1.6535		
47	47	1.8504	46.994	1.85015	47.008	1.8507	47	1.8504		
52	52	2.0472	51.993	2.0469	52.008	2.0475	52	2.0472		
55	55	2.1654	54.993	2.1651	55.008	2.1657	55	2.1654		
58	58	2.2835	57.993	2.2832	58.008	2.2838	58	2.2835		
62	62	2.4409	61.993	2.4406	62.008	2.4412	62	2.4409		
65	65	2.5591	64.993	2.5588	65.008	2.5594	65	2.5591	15L	6L
66	66	2.5772	67.993	2.5769	68.008	2.5775	68	2.5772	0	0
70	70	2.7559	69.993	2.7556	70.008	2.7562	70	2.7559		
72	72	2.8346	71.993	2.8343	72.008	2.8349	72	2.8346		
75	75	2.9528	74.993	2.9525	75.008	2.9531	75	2.9528		
78	78	3.0709	77.993	3.0706	78.008	3.0712	78	3.0709		
80	80	3.1496	79.993	3.1493	80.008	3.1499	80	3.1496		
85	85	3.3465	84.992	3.3462	85.010	3.3469	85	3.3465		
90	90	3.5433	89.992	3.5430	90.010	3.5437	90	3.5433		
95	95	3.7402	94.992	3.7399	95.010	3.7406	95	3.7402		
100	100	3.9370	99.992	3.9367	100.010	3.9374	100	3.9370	18L	7L
105	105	4.1339	104.992	4.1336	105.010	4.1343	105	4.1339	0	0
110	110	4.3307	109.992	4.3304	110.010	4.3311	110	4.3307		
115	115	4.5276	114.992	4.5273	115.010	4.5280	115	4.5276		
120	120	4.7244	119.992	4.7241	120.010	4.7248	120	4.7244		
125	125	4.9213	124.991	4.92095	125.013	4.9218	125	4.9213		
130	130	5.1181	129.991	5.11775	130.013	5.1186	130	5.1181		
135	135	5.3150	134.991	5.31465	135.013	5.3155	135	5.3150	22L	8.5L
140	140	5.5118	139.991	5.51145	140.013	5.5123	140	5.5118	0	0
145	145	5.7087	144.991	5.70835	145.013	5.7092	145	5.7087		
150	150	5.9055	149.991	5.90515	150.013	5.9060	150	5.9055		
160	160	6.2992	159.990	6.2988	160.013	6.2997	160	6.2992		
165	165	6.4961	164.990	6.4957	165.013	6.4966	165	6.4961		
170	170	6.6929	169.990	6.6925	170.013	6.6934	170	6.6929	23L	9L
175	175	6.8898	174.990	6.8894	175.013	6.8903	175	6.8898	0	0
180	180	7.0866	179.990	7.0862	180.013	7.0871	180	7.0866		
190	190	7.4803	189.989	7.47985	190.015	7.4809	190	7.4803		
200	200	7.8740	199.989	7.87355	200.015	7.8746	200	7.8740		
205	205	8.0709	204.989	8.07045	205.015	8.0715	205	8.0709		
210	210	8.2677	209.989	8.26725	210.015	8.2683	210	8.2677		
215	215	8.4646	214.989	8.46415	215.015	8.4652	215	8.4646	26L	10.5L
220	220	8.6614	219.989	8.66095	220.015	8.6620	220	8.6614	0	0
225	225	8.8583	224.989	8.85785	225.015	8.8589	225	8.8583		
230	230	9.0551	229.989	9.05465	230.015	9.0557	230	9.0551		
235	235	9.2520	234.989	9.25155	235.015	9.2526	235	9.2520		
240	240	9.4488	239.989	9.44835	240.015	9.4494	240	9.4488		
250	250	9.8425	249.989	9.84205	250.015	9.8431	250	9.8425		
260	260	10.2362	259.987	10.2357	260.015	10.2368	260	10.2362		
265	265	10.4331	264.987	10.4326	265.015	10.4337	265	10.4331		
270	270	10.6299	269.987	10.6294	270.015	10.6305	270	10.6299		
280	280	11.0236	279.987	11.0231	280.015	11.0242	280	11.0236	28L	11L
290	290	11.4173	289.987	11.4168	290.015	11.4179	290	11.4173	0	0
300	300	11.8110	299.987	11.8105	300.015	11.8116	300	11.8110		
310	310	12.2047	309.987	12.2042	310.015	12.2053	310	12.2047		
320	320	12.5984	319.985	12.5978	320.018	12.5991	320	12.5984		
340	340	13.3858	339.985	13.3852	340.018	13.3865	340	13.3858		
350	350	13.7795	349.985	13.7789	350.018	13.7802	350	13.7795		
360	360	14.1732	359.985	14.1726	360.018	14.1739	360	14.1732	33L	13L
370	370	14.5669	369.985	14.5663	370.018	14.5676	370	14.5669	0	0
380	380	14.9606	379.985	14.9600	380.018	14.9613	380	14.9606		
390	390	15.3543	389.985	15.3537	390.018	15.3550	390	15.3543		
400	400	15.7480	399.985	15.7474	400.018	15.7487	400	15.7480		

For aluminum or other soft metal housings, make bore limits same as O.D. limits of bearing.

Bearing Outside Diameter					Housing Stationary					
Max		Min			Housing Bore				Fit	
mm		mm			Max		Min		.001	.0001
mm	in	mm	in	mm	in	mm	in	mm	in	
R2	9.525	0.3750	9.521	0.37485	9.533	0.3753	9.525	0.3750	12L	4.5L
R2A	12.700	0.5000	12.696	0.49985	12.708	0.5003	12.700	0.5000	0	0
R3	12.700	0.5000	12.696	0.49985	12.708	0.5003	12.700	0.5000	0	0
R4	15.875	0.6250	15.871	0.62485	15.883	0.6253	15.875	0.6250		
R4A	19.050	0.7500	19.045	0.7498	19.058	0.7503	19.050	0.7500		
R6	22.225	0.8750	22.220	0.8748	22.233	0.8753	22.225	0.8750	13L	5L
R8	28.575	1.1250	28.570	1.1248	28.583	1.1253	28.575	1.1250	0	0
R10	34.925	1.3750	34.919	1.37475	34.933	1.3753	34.925	1.3750	14L	5.5L
R12	41.275	1.6250	41.269	1.62475	41.283	1.6253	41.275	1.6250	0	0
R14	47.625	1.8750	47.619	1.87475	47.633	1.8753	47.625	1.8750		
R16	50.800	2.0000	50.793	1.9997	50.808	2.0003	50.800	2.0000		
R18	53.975	2.1250	53.968	2.1247	53.983	2.1253	53.975	2.1250		
R20	57.150	2.2500	57.143	2.2497	57.158	2.2503	57.150	2.2500	15L	6L
R24	66.675	2.6250	66.668	2.6247	66.683	2.6253	66.675	2.6250	0	0
XLS1% ₆	65.088	2.5625	65.081	2.5622	65.096	2.5628	65.088	2.5625		
XLS1% ₂	68.263	2.6875	68.256	2.6872	68.271	2.6878	68.263	2.6875		
XLS1% ₁	73.025	2.8750	73.018	2.8747	73.033	2.8753	73.025	2.8750		
XLS1% ₄	76.200	3.0000	76.193	2.9997	76.203	3.0003	76.200	3.0000		
XLS17% ₆	80.963	3.1875	80.955	3.1872	80.973	3.1879	80.963	3.1875		
XLS2% ₂	84.138	3.3125	84.130	3.3122	84.138	3.3129	84.138	3.3125		
XLS2% ₁	87.313	3.4375	87.305	3.4372	87.323	3.4379	87.313	3.4375		
XLS2% ₄	90.488	3.5625	90.480	3.5622	90.498	3.5629	90.488	3.5625	18L	7L
XLS2% ₂	98.425	3.8750	98.417	3.8747	98.435	3.8754	98.425	3.8750	0	0
XLS2% ₁	104.775	4.1250	104.767	4.1247	104.785	4.1254	104.775	4.1250		
XLS2% ₄	104.775	4.1250	104.767	4.1247	104.785	4.1254	104.775	4.1250		
XLS3% ₃	114.300	4.5000	114.292	4.4997	114.310	4.5004	114.300	4.5000		
XLS3% ₄	120.650	4.7500	120.641	4.74965	120.663	4.7505	120.650	4.7500	22L	8.5L
XLS3% ₂	127.000	5.0000	126.991	4.99965	127.013	5.0005	127.000	5.0000	0	0
XLS3% ₁	133.350	5.2500	133.341	5.24965	133.365	5.2505	133.350	5.2500		
XLS4% ₄	152.400	6.0000	152.390	5.9996	152.413	6.0005	152.400	6.0000		
XLS4% ₂	158.750	6.2500	158.740	6.2496	158.763	6.2505	158.750	6.2500	23L	9L
XLS4% ₁	165.100	6.5000	165.090	6.4996	165.113	6.5005	165.100	6.5000	0	0
XLS5% ₅	177.800	7.0000	177.790	6.9996	177.813	7.0005	177.800	7.0000		
XLS5% ₂	190.500	7.5000	190.489	7.49955	190.515	7.5006	190.500	7.5000		
XLS6% ₆	203.200	8.0000	203.189	7.99955	203.215	8.0006	203.200	8.0000		
XLS6% ₄	215.900	8.5000	215.889	8.49955	215.915	8.5006	215.900	8.5000	26L	10.5L
XLS6% ₂	222.250	8.7500	222.239	8.74955	222.265	8.75				

Listed below are bearing types that require special shaft and housing diameters and resulting fits. The shaft and housing diameters corresponding to the ISO

designations are shown in the tables on pages 266 to 267. The description of each bearing type may be found on the page listed.

MRC Bearing Type	ISO Housing Diameter	ISO Shaft Diameter	Page
PumPac 8000 Series	H6	k5	180
Duplex, flush ground, free running no end play (DU)	H6	h5	237
Duplex with end play (DE)	H6	k5	237
Duplex with preload (DS)	H6	h5	237
1800S thin section	H6 Housing Stationary	j5 Shaft Rotating	46
	J6 Housing Rotating	h5 Shaft Stationary	
Electric Motor Quality (EMQ)	See special housing diameters on page 222.	j5	209
Adapter Type (SX), Tapered Bore	H6 Housing Stationary	See mounting instructions on page 172.	202
	N6 Housing Revolving		
Self-Aligning Double Row	H6 Housing Stationary	See mounting instructions on page 172.	157
	N6 Housing Revolving		

The ISO Shaft Tolerances listed are shown in the tables on pages 266 & 267.

Radial Bearings With Cylindrical Bore

Conditions	Examples	Shaft Diameter, MM			Tolerance
		Ball Bearings	Cylindrical, Needle, Metric Tapered Roller	Spherical Roller Bearings	
Inner Ring Rotation or Direction of Load Indeterminate*					
Light and variable loads ($P \leq 0.06C$)	Conveyors, light loaded gearbox bearings	(18) to 100 (100) to 140	≤ 40 (40) to 100	—	j6 k6
Normal and heavy loads ($P > 0.06C$)	General bearing applications, electric motors, turbines, pumps, internal combustion engines, gearing, woodworking machines	≤ 18 (18) to 100 (100) to 140 (140) to 200 (200) to 280 — — —	— ≤ 40 (40) to 100 (100) to 140 (140) to 200 (200) to 400 — — —	— ≤ 40 (40) to 65 (65) to 100 (100) to 140 (140) to 280 (280) to 500 > 500	j5 k5(k6) ¹⁾ m5(m6) ¹⁾ m6 n6 p6 r6 ²⁾ r7 ²⁾
Very heavy loads and shock loads with difficult working conditions ($P > 0.12C$)	Axleboxes for heavy railway vehicles, traction motors, rolling mills	— — —	(50) to 140 (140) to 200 > 200	(50) to 100 (100) to 140 > 140	n6 ²⁾ p6 ²⁾ r6 ²⁾
High demands on running accuracy with light loads ($P \leq 0.06C$)	Machine tools	≤ 18 (18) to 100 (100) to 200 —	— ≤ 40 (40) to 140 (140) to 200	— — — —	h5 ³⁾ j5 ³⁾ k5 ³⁾ m5 ³⁾

Outer Ring Rotation

Easy axial displacement of inner ring on shaft desirable	Wheels on non-rotating axles				g6
Easy axial displacement of inner ring on shaft unnecessary	Tension pulleys, rope sheaves				h6

Axial Loads Only

Bearing Applications of all Kinds					j6
-----------------------------------	--	--	--	--	----

*Variable external loads, shock loads, and vibratory and unbalanced loads in high-speed machinery cannot be accurately described and are classified as "direction of load indeterminate."

¹⁾ The tolerances in brackets are generally used for metric tapered roller bearings and single-row angular contact ball bearings. May also be used for other bearing types where speeds are moderate and the effect on internal clearance variation is not significant.

²⁾ Bearings with radial internal clearance greater than normal may be necessary

³⁾ Not applicable to high precision bearings

Thrust Bearings

Conditions	Shaft Diameter, mm	Tolerance
Axial Loads Only		
Thrust ball bearings		h6
Cylindrical roller thrust bearings		h6
Radial and axial loads on spherical roller thrust bearings		
Stationary load on shaft washer	≤ 250	j6
Rotating load on shaft washer or direction of load indeterminate	≤ 200 (200) to 400 > 400	k6 m6 n6

Shaft Bearing-Seat Diameters (Values in Inches)

Bearing Bore Diameter			g6			h6			h5			j5			j6			k5		
			Shaft Dia.		Fit in 0.0001"	Shaft Dia.		Fit in 0.0001"	Shaft Dia.		Fit in 0.0001"	Shaft Dia.		Fit in 0.0001"	Shaft Dia.		Fit in 0.0001"	Shaft Dia.		Fit in 0.0001"
mm	Inches		Max.	Min.		Max.	Min.		Max.	Min.		Max.	Min.		Max.	Min.		Max.	Min.	
	4	0.1575	0.1572	0.1573	0.1570		0.1575	0.1572		0.1575	0.1573		0.1576	0.1574		0.1577	0.1574		0.1577	0.1575
5	0.1969	0.1966	0.1967	0.1964	5L	0.1969	0.1966	3L	0.1969	0.1967	2L	0.1970	0.1968	1L	0.1971	0.1968	5L	0.1971	0.1969	
6	0.2362	0.2359	0.2360	0.2357	1T	0.2362	0.2359	3T	0.2362	0.2360	3T	0.2363	0.2361	4T	0.2364	0.2361	1T	0.2364	0.2362	
7	0.2756	0.2753	0.2754	0.2750		0.2756	0.2752		0.2756	0.2754		0.2758	0.2755		0.2759	0.2755		0.2759	0.2756	
8	0.3150	0.3147	0.3148	0.3144	6L	0.3150	0.3146	4L	0.3150	0.3148	2L	0.3152	0.3149	1T	0.3153	0.3149	6T	0.3153	0.3150	
9	0.3543	0.3540	0.3541	0.3537	1T	0.3543	0.3539	3T	0.3543	0.3541	3T	0.3545	0.3542	5T	0.3546	0.3542	1T	0.3546	0.3543	
10	0.3937	0.3934	0.3935	0.3931		0.3937	0.3933		0.3937	0.3935		0.3939	0.3936		0.3940	0.3936		0.3940	0.3937	
12	0.4724	0.4721	0.4722	0.4717		0.4724	0.4720		0.4724	0.4721		0.4726	0.4723		0.4727	0.4723		0.4728	0.4724	
15	0.5906	0.5903	0.5904	0.5899	7L	0.5906	0.5902	4L	0.5906	0.5903	3L	0.5908	0.5905	1L	0.5909	0.5905	1L	0.5910	0.5906	
17	0.6693	0.6690	0.6691	0.6686	1T	0.6693	0.6689	3T	0.6693	0.6690	3T	0.6695	0.6692	5T	0.6696	0.6692	6T	0.6697	0.6693	
20	0.7874	0.7870	0.7871	0.7866		0.7874	0.7869		0.7874	0.7870		0.7876	0.7872		0.7878	0.7872		0.7878	0.7875	
25	0.9843	0.9839	0.9840	0.9835	8L	0.9843	0.9838	5L	0.9843	0.9839	4L	0.9845	0.9841	2L	0.9847	0.9841	2L	0.9847	0.9844	
30	1.1811	1.1807	1.1808	1.1803	1T	1.1811	1.1806	4T	1.1811	1.1807	4T	1.1813	1.1809	6T	1.1815	1.1809	8T	1.1815	1.1812	
35	1.3780	1.3775	1.3776	1.3770		1.3780	1.3774		1.3780	1.3776		1.3782	1.3778		1.3784	1.3778		1.3785	1.3781	
40	1.5748	1.5743	1.5744	1.5738	10L	1.5748	1.5742	6L	1.5748	1.5744	4L	1.5750	1.5746	2L	1.5752	1.5746	2L	1.5753	1.5749	
45	1.7717	1.7712	1.7713	1.7707	1T	1.7717	1.7711	5T	1.7717	1.7713	5T	1.7719	1.7715	7T	1.7721	1.7715	9T	1.7722	1.7718	
50	1.9685	1.9680	1.9681	1.9675		1.9685	1.9679		1.9685	1.9681		1.9687	1.9683		1.9689	1.9683		1.9690	1.9686	
55	2.1654	2.1648	2.1650	2.1643		2.1654	2.1647		2.1654	2.1649		2.1656	2.1651		2.1659	2.1651		2.1660	2.1655	
60	2.3622	2.3616	2.3618	2.3611		2.3622	2.3615		2.3622	2.3617		2.3624	2.3619		2.3627	2.3619		2.3628	2.3623	
65	2.5591	2.5585	2.5587	2.5580	11L	2.5591	2.5584	7L	2.5591	2.5586	5L	2.5593	2.5588	3L	2.5596	2.5588	3L	2.5597	2.5592	
70	2.7559	2.7553	2.7555	2.7548	2T	2.7559	2.7552	6T	2.7559	2.7554	6T	2.7561	2.7556	8T	2.7564	2.7556	11T	2.7565	2.7560	
75	2.9528	2.9522	2.9524	2.9517		2.9528	2.9521		2.9528	2.9523		2.9530	2.9525		2.9533	2.9525		2.9534	2.9529	
80	3.1496	3.1490	3.1492	3.1485		3.1496	3.1489		3.1496	3.1491		3.1498	3.1493		3.1501	3.1493		3.1502	3.1497	
85	3.3465	3.3457	3.3460	3.3452		3.3465	3.3456		3.3465	3.3459		3.3467	3.3461		3.3470	3.3461		3.3472	3.3466	
90	3.5433	3.5425	3.5428	3.5420		3.5433	3.5424		3.5433	3.5427		3.5435	3.5429		3.5438	3.5429		3.5440	3.5434	
95	3.7402	3.7394	3.7397	3.7389		3.7402	3.7393		3.7402	3.7396		3.7404	3.7398		3.7407	3.7398		3.7409	3.7403	
100	3.9370	3.9362	3.9365	3.9357	13L	3.9370	3.9361	9L	3.9370	3.9364	6L	3.9372	3.9366	4L	3.9375	3.9366	4L	3.9377	3.9371	
105	4.1339	4.1331	4.1334	4.1326	3T	4.1339	4.1330	8T	4.1339	4.1333	8T	4.1341	4.1335	10T	4.1344	4.1335	13T	4.1346	4.1340	
110	4.3307	4.3299	4.3302	4.3294		4.3307	4.3298		4.3307	4.3301		4.3309	4.3303		4.3312	4.3303		4.3314	4.3308	
115	4.5276	4.5268	4.5271	4.5263		4.5276	4.5267		4.5276	4.5270		4.5278	4.5272		4.5281	4.5272		4.5283	4.5277	
120	4.7244	4.7236	4.7239	4.7231		4.7244	4.7235		4.7244	4.7238		4.7246	4.7240		4.7249	4.7240		4.7251	4.7245	
125	4.9213	4.9203	4.9207	4.9198		4.9213	4.9203		4.9213	4.9206		4.9216	4.9209		4.9219	4.9209		4.9221	4.9214	
130	5.1181	5.1171	5.1175	5.1166		5.1181	5.1171		5.1181	5.1174		5.1184	5.1177		5.1187	5.1177		5.1189	5.1182	
140	5.5118	5.5108	5.5112	5.5103		5.5118	5.5108		5.5118	5.5111		5.5121	5.5114		5.5124	5.5114		5.5126	5.5119	
150	5.9055	5.9045	5.9049	5.9040	15L	5.9055	5.9045	10L	5.9055	5.9048	7L	5.9058	5.9051	4L	5.9061	5.9051	4L	5.9063	5.9056	
160	6.2992	6.2982	6.2986	6.2977	4T	6.2992	6.2982	10T	6.2992	6.2985	10T	6.2995	6.2988	13T	6.2998	6.2988	16T	6.3000	6.2993	
170	6.6929	6.6919	6.6923	6.6914		6.6929	6.6919		6.6929	6.6922		6.6932	6.6925		6.6935	6.6925		6.6937	6.6930	
180	7.0866	7.0856	7.0860	7.0851		7.0866	7.0856		7.0866	7.0859		7.0869	7.0862		7.0872	7.0862		7.0874	7.0867	
190	7.4803	7.4791	7.4797	7.4786		7.4803	7.4792		7.4803	7.4795		7.4806	7.4798		7.4809	7.4798		7.4812	7.4805	
200	7.8740	7.8728	7.8734	7.8723	17L	7.8740	7.8729	11L	7.8740	7.8732	8L	7.8743	7.8735	5L	7.8746	7.8735	5L	7.8749	7.8742	
220	8.6614	8.6602	8.6608	8.6597	6T	8.6614	8.6603	12T	8.6614	8.6606	12T	8.6617	8.6609	15T	8.6620	8.6609	18T	8.6623	8.6616	
240	9.4488	9.4476	9.4482	9.4471		9.4488	9.4477		9.4488	9.4480		9.4491	9.4483		9.4494	9.4483		9.4497	9.4490	
250	9.8425	9.8413	9.8419	9.8408		9.8425	9.8414		9.8425	9.8417		9.8428	9.8420		9.8431	9.8420		9.8434	9.8427	
260	10.2362	10.2348	10.2355	10.2343		10.2362	10.2349		10.2362	10.2353		10.2365	10.2356		10.2368	10.2356		10.2373	10.2364	
280	11.0236	11.0222	11.0229	11.0217	19L	11.0236	11.0223	13L	11.0236	11.0225	9L	11.0239	11.0230	6L	11.0242	11.0230	6L	11.0247	11.0238	
300	11.8110	11.8096	11.8103	11.8091	7T	11.8110	11.8097	14T	11.8110	11.8101	14T	11.8113	11.8104	17T	11.8116	11.8104	20T	11.8121	11.8112	
310	12.2047	12.2033	12.2040	12.2028		12.2047	12.2034		12.2047	12.2038		12.2050	12.2041		12.2053	12.2041		12.2058	12.2049	
320	12.5984	12.5968	12.5977	12.5963		12.5984	12.5970		12.5984	12.5974		12.5987	12.5977		12.5991	12.5977		12.5995	12.5986	
340	13.3858	13.3842	13.3851	13.3837		13.3858	13.3844		13.3858	13.3848		13.3861	13.3851		13.3865	13.3851		13.3869	13.3860	
350	13.7795	13.7779	13.7788	13.7771	21L	13.7795	13.7781	14L	13.7795	13.7785	10L	13.7798	13.7788	7L	13.7802	13.7788	7L	13.7806	13.7797	
360	14.1732	14.1716	14.1725	14.1711	9T	14.1732	14.1718	16T	14.1732	14.1722	16T	14.1735	14.1725	19T	14.1739	14.1725	23T	14.1743	14.1734	
380	14.9606	14.9590	14.9599	14.9585		14.9606	14.9592		14.9606	14.9596		14.9609	14.9599		14.9613	14.9599		14.9617	14.9608	
400	15.7480	15.7464	15.7473	15.7459		15.7480	15.7466		15.7480	15.7470		15.7483	15.7473		15.7487	15.7473		15.7491	15.7482	
420	16.5354	16.5336	16.5346	16.5330		16.5354	16.5338		16.5354	16.5343		16.5357	16.5346		16.5362	16.5346		16.5367	16.5356	
440	17.322																			

Shaft Bearing-Seat Diameters (Values in Inches)

Brg. Bore Dia. mm	k6			m5			m6			n6			p6			r6			r7		
	Shaft Dia.		Fit in 0.0001"	Shaft Dia.		Fit in 0.0001"	Shaft Dia.		Fit in 0.0001"	Shaft Dia.		Fit in 0.0001"	Shaft Dia.		Fit in 0.0001"	Shaft Dia.		Fit in 0.0001"	Shaft Dia.		Fit in 0.0001"
	Max.	Min.		Max.	Min.		Max.	Min.		Max.	Min.		Max.	Min.		Max.	Min.		Max.	Min.	
4	0.1579	0.1575		0.1579	0.1577		0.1580	0.1577		0.1581	0.1578										
5	0.1973	0.1969	0T	0.1973	0.1971	2T	0.1974	0.1971	2T	0.1975	0.1972	3T									
6	0.2366	0.2362	7T	0.2366	0.2364	7T	0.2367	0.2364	8T	0.2368	0.2365	9T									
7	0.2760	0.2756		0.2761	0.2758		0.2762	0.2758		0.2764	0.2760										
8	0.3154	0.3150	0T	0.3155	0.3152	2T	0.3156	0.3152	2T	0.3158	0.3154	4T									
9	0.3547	0.3543	7T	0.3548	0.3545	8T	0.3549	0.3545	9T	0.3551	0.3547	11T									
10	0.3941	0.3937		0.3942	0.3939		0.3943	0.3939		0.3945	0.3941										
12	0.4729	0.4724		0.4730	0.4727		0.4731	0.4727		0.4733	0.4729										
15	0.5911	0.5906	0T	0.5912	0.5909	3T	0.5913	0.5909	3T	0.5915	0.5911	5T									
17	0.6698	0.6693	8T	0.6699	0.6696	9T	0.6700	0.6696	10T	0.6702	0.6698	12T									
20	0.7880	0.7875		0.7881	0.7877		0.7882	0.7877		0.7885	0.7880										
25	0.9849	0.9844	1T	0.9850	0.9846	3T	0.9851	0.9846	3T	0.9854	0.9849	6T									
30	1.1817	1.1812	10T	1.1818	1.1814	11T	1.1819	1.1814	12T	1.1822	1.1817	15T									
35	1.3787	1.3781		1.3788	1.3784		1.3790	1.3784		1.3793	1.3787										
40	1.5755	1.5749	1T	1.5756	1.5752	4T	1.5758	1.5752	4T	1.5761	1.5655	7T									
45	1.7724	1.7718	12T	1.7725	1.7721	13T	1.7727	1.7721	15T	1.7730	1.7724	18T									
50	1.9692	1.9686		1.9693	1.9689		1.9695	1.9689		1.9698	1.9692										
55	2.1662	2.1655		2.1663	2.1658		2.1666	2.1658		2.1669	2.1662										
60	2.3630	2.3623		2.3631	2.3626		2.3634	2.3626		2.3637	2.3630										
65	2.5599	2.5592	1T	2.5600	2.5595	4T	2.5603	2.5595	4T	2.5606	2.5599	8T									
70	2.7567	2.7560	14T	2.7568	2.7563	15T	2.7571	2.7563	18T	2.7574	2.7567	21T									
75	2.9536	2.9529		2.9537	2.9532		2.9540	2.9532		2.9543	2.9536										
80	3.1504	3.1497		3.1505	3.1500		3.1508	3.1500		3.1511	3.1504										
85	3.3475	3.3466		3.3476	3.3470		3.3479	3.3470		3.3483	3.3474										
90	3.5443	3.5434		3.5444	3.5438		3.5447	3.5438		3.5451	3.5442										
95	3.7412	3.7403		3.7413	3.7407		3.7416	3.7407		3.7420	3.7411										
100	3.9380	3.9371	1T	3.9381	3.9375	5T	3.9384	3.9375	5T	3.9388	3.9379	9T									
105	4.1349	4.1340	18T	4.1350	4.1344	19T	4.1353	4.1344	22T	4.1357	4.1348	26T									
110	4.3317	4.3308		4.3318	4.3312		4.3321	4.3312		4.3325	4.3316										
115	4.5286	4.5277		4.5287	4.5281		4.5290	4.5281		4.5294	4.5285										
120	4.7254	4.7245		4.7255	4.7249		4.7258	4.7249		4.7262	4.7253										
125	4.9224	4.9214		4.9225	4.9219		4.9229	4.9219		4.9233	4.9224										
130	5.1192	5.1182		5.1193	5.1187		5.1197	5.1187		5.1201	5.1192										
140	5.5129	5.5119		5.5131	5.5124		5.5134	5.5124		5.5138	5.5129										
150	5.9066	5.9056	1T	5.9068	5.9061	6T	5.9071	5.9061	6T	5.9075	5.9066	11T									
160	6.3003	6.2993	21T	6.3005	6.2998	23T	6.3008	6.2998	26T	6.3012	6.3003	30T									
170	6.6940	6.6930		6.6942	6.6935		6.6945	6.6935		6.6949	6.6940										
180	7.0877	7.0867		7.0879	7.0872		7.0882	7.0872		7.0886	7.0877										
190	7.4816	7.4805		7.4818	7.4810		7.4821	7.4810		7.4827	7.4815										
200	7.8753	7.8742	2T	7.8755	7.8747	7T	7.8758	7.8747	7T	7.8764	7.8752	12T									
220	8.6627	8.6616	25T	8.6629	8.6621	27T	8.6632	8.6621	30T	8.6638	8.6626	36T									
240	9.4501	9.4490		9.4503	9.4495		9.4506	9.4495		9.4512	9.4500										
250	9.8438	9.8427		9.8440	9.8432		9.8443	9.8432		9.8449	9.8437										
260	10.2376	10.2364		10.2379	10.2370		10.2382	10.2370		10.2388	10.2375										
280	11.0250	11.0238	2T	11.0253	11.0244	8T	11.0256	11.0244	8T	11.0262	11.0249	13T									
300	11.8124	11.8112	28T	11.8127	11.8118	31T	11.8130	11.8118	34T	11.8136	11.8123	40T									
310	12.2061	12.2049		12.2064	12.2055		12.2067	12.2055		12.2073	12.2060										
320	12.5997	12.5986		12.6002	12.5992		12.6006	12.5992		12.6013	12.5999										
340	13.3873	13.3860		13.3876	13.3866		13.3880	13.3866		13.3887	13.3873										
350	13.7810	13.7797	2T	13.7813	13.7803	8T	13.7817	13.7803	8T	13.7824	13.7810	15T									
360	14.1747	14.1734	31T	14.1750	14.1740	34T	14.1754	14.1740	38T	14.1761	14.1747	45T									
380	14.9621	14.9608		14.9624	14.9614		14.9628	14.9614		14.9635	14.9621										
400	15.7495	15.7482		15.7498	15.7488		15.7502	15.7488		15.7509	15.7495										
420	16.5371	16.5356		16.5374	16.5363		16.5379	16.5363		16.5385	16.5370										
440	17.3245	17.3230	2T	17.3248	17.3237	9T	17.3253	17.3237	9T	17.3259	17.3244	16T									
460	18.1119	18.1104	35T	18.1122	18.1111	38T	18.1127	18.1111	43T	18.1133	18.1118	49T									
480	18.8993	18.8978		18.8996	18.8985		18.9001	18.8985		18.9007	18.8992										
500	19.6867	19.6852		19.6870	19.6859		19.6875	19.6859		19.6881	19.6866										
530	20.8678	20.8661		20.8683	20.8671		20.8689	20.8671		20.8695	20.8678										
560	22.0489	22.0472	0T	22.0494	22.0482	10T	22.0500	22.0489	17T	22.0506	22.0489	54T									
600	23.6237	23.6220	37T	23.6242	23.6230	42T	23.6254	23.6230	54T	23.6268	23.6251	68T									
630	24.8048	24.8031		24.8053	24.8041		24.8065	24.8041		24.8079	24.8062										
660	25.9862	25.9843		25.9869	25.9855		25.9878	25.9855		25.9897	25.9878										
670	26.3799	26.3780		26.3806	26.3792		26.3819	26.3792		26.3834	26.3815										
710	27.9547	27.9528	0T	27.9554	27.9540	12T	27.9567	27.9540	20T	27.9582	27.9563	25T									
750	29.5295	29.5276	49T	29.5302	29.5288	56T	29.5315	29.5296	69T	29.5330	29.5311	84T									
780	30.7106	30.7087		30.7113	30.7099		30.7126	30.7107		30.7141	30.7122										
800	31.4980	31.4961		31.4987	31.4973		31.5000	31.4981		31.5015	31.4996										
850	33.4668	33.4646		33.4675	33.4659		33.4690	33.4668		33.4707	33.4685										
900	35.4353	35.4331	0T	35.4360	35.4344	13T	35.4375	35.4353	22T	35.4392	35.4370	39T									
950	37.4038	37.4016	61T	37.4045	37.4029	68T	37.4060	37.4038	83T	37.4077	37.4055	100T									
1000	39.3723	39.3701		39.3730	39.3714		39.3745	39.3723		39.3762	39.3740										
1060	41.7349	41.7323		41.7357	41.7339		41.7375	41.7349		41.7394	41.7370										

The ISO Housing Tolerances listed are shown in the tables on pages 269 to 271.

Radial Bearings

Conditions	Examples	Tolerance	Displacement of Outer Ring
Inner Ring Rotation			
Loads of all kinds	General bearing applications, railway axleboxes	H6 ¹⁾	Can be displaced
Light and normal loads ($P \leq 0.12C$) with simple working conditions	General bearing applications	H8	Can be displaced
Heat conduction through shaft	Drying cylinders, large electrical machines with spherical roller bearings	G7 ²⁾	Can be displaced
Direction of Load Indeterminate*			
Light and normal loads ($P \leq 0.12C$) axial displacement of outer ring desirable	Medium-size electrical machines, pumps, crankshaft bearings	J7	Can usually be displaced
Heavy shock loads	Electric traction motors	M7	Cannot be displaced
Normal and heavy loads ($P > 0.06C$). Axial displacement of outer ring unnecessary	Electrical motors, pumps, crankshaft bearings	K7	Cannot usually be displaced
Outer Ring Rotation			
Heavy loads on bearings in thin-walled housings, heavy shock loads	Roller bearing wheel hubs, big end bearings	P7	Cannot be displaced
Normal and heavy loads ($P > 0.06C$)	Ball bearing wheel hubs, big end bearings, crane travelling wheels	N7	Cannot be displaced
Light and variable loads ($P \leq 0.06C$)	Conveyor rollers, rope sheaves, belt tension pulleys	M7	Cannot be displaced
Accurate or Silent Running³⁾			
Light Loads	Small Electric Motors	J6 ²⁾	Can be displaced

*Variable external loads, shock loads, and vibratory and unbalanced loads in high-speed machinery cannot be accurately described and are classified as "direction of load indeterminate."

¹⁾ For large bearings ($D > 250$ mm) and temperature difference between outer ring and housing $> 10^\circ\text{C}$, use G7.

²⁾ For large bearings ($D > 250$ mm) and temperature difference between outer ring and housing $> 10^\circ\text{C}$, use F7.

³⁾ Not applicable to high precision bearings

Thrust Bearings

Conditions	Tolerance	Remarks
Axial Loads Only		
Thrust ball bearings	H8	For less accurate bearing arrangements radial looseness can be up to 0.001D
Cylindrical Roller Thrust Bearings	H7	
Spherical Roller Thrust Bearings with another bearing use for radial location	—	Housing washer fitted with radial clearance of up to 0.0001D
Radial and axial loads on spherical roller thrust bearings		
Stationary load on housing washer	H7	
Rotating load on housing washer	M7	

Housing Bearing-Seat Diameters (Values in Inches)

mm	Bearing Outside Diameter		F7				G7				H8				H7				H6			
	Inches		Housing Bore		Fit in 0.0001*	Housing Bore		Fit in 0.0001*	Housing Bore		Fit in 0.0001*	Housing Bore		Fit in 0.0001*	Housing Bore		Fit in 0.0001*	Housing Bore		Fit in 0.0001*		
	Max	Min.	Max.	Min.		Max.	Min.		Max.	Min.		Max.	Min.		Max.	Min.		Max.	Min.		Max.	Min.
16	0.6299	0.6296	0.6305	0.6312	16L 6L	0.6301	0.6308	12L 2L	0.6299	0.6310	14L 0	0.6299	0.6306	10L 0	0.6299	0.6303	7L 0					
19	0.7480	0.7476	0.7488	0.7496		0.7483	0.7491		0.7480	0.7493		0.7480	0.7488		0.7480	0.7485						
21	0.8268	0.8264	0.8276	0.8284		0.8271	0.8279		0.8268	0.8281		0.8268	0.8276		0.8268	0.8273						
22	0.8661	0.8657	0.8669	0.8677		0.8664	0.8672		0.8661	0.8674		0.8661	0.8669		0.8661	0.8666						
24	0.9449	0.9445	0.9457	0.9465	20L	0.9452	0.9460	15L	0.9449	0.9462	17L	0.9449	0.9457	12L	0.9449	0.9454	9L					
26	1.0236	1.0232	1.0244	1.0252	8L	1.0239	1.0247	3L	1.0236	1.0249	0	1.0236	1.0244	0	1.0236	1.0241	0					
28	1.1024	1.1020	1.1032	1.1040		1.1027	1.1035		1.1024	1.1037		1.1024	1.1032		1.1024	1.1029						
30	1.1811	1.1807	1.1819	1.1827		1.1814	1.1822		1.1811	1.1824		1.1811	1.1819		1.1811	1.1816						
32	1.2598	1.2594	1.2606	1.2614		1.2602	1.2610		1.2598	1.2613		1.2598	1.2606		1.2598	1.2604						
35	1.3780	1.3776	1.3790	1.4000		1.3784	1.3793		1.3780	1.3795		1.3780	1.3790		1.3780	1.3786						
37	1.4567	1.4563	1.4577	1.4587	24L	1.4571	1.4580	17L	1.4567	1.4582	19L	1.4567	1.4577	14L	1.4567	1.4573	10L					
40	1.5748	1.5744	1.5758	1.5768	10L	1.5752	1.5761	4L	1.5748	1.5763	0	1.5748	1.5758	0	1.5748	1.5754	0					
42	1.6535	1.6531	1.6545	1.6555		1.6539	1.6548		1.6535	1.6550		1.6535	1.6545		1.6535	1.6541						
47	1.8504	1.8500	1.8514	1.8524		1.8508	1.8517		1.8504	1.8519		1.8504	1.8514		1.8504	1.8510						
52	2.0472	2.0467	2.0484	2.0496		2.0476	2.0488		2.0472	2.0490		2.0472	2.0484		2.0472	2.0479						
55	2.1654	2.1649	2.1666	2.1678		2.1658	2.1670		2.1654	2.1672		2.1654	2.1666		2.1654	2.1661						
58	2.2835	2.2830	2.2847	2.2859		2.2839	2.2851		2.2835	2.2853		2.2835	2.2847		2.2835	2.2842						
62	2.4409	2.4404	2.4421	2.4433	29L	2.4413	2.4425	21L	2.4409	2.4427	23L	2.4409	2.4421	17L	2.4409	2.4416	12L					
65	2.5591	2.5586	2.5603	2.5615	12L	2.5595	2.5607	4L	2.5591	2.5609	0	2.5591	2.5603	0	2.5591	2.5598	0					
70	2.7559	2.7554	2.7571	2.7583		2.7563	2.7575		2.7559	2.7577		2.7559	2.7571		2.7559	2.7566						
72	2.8346	2.8341	2.8358	2.8370		2.8350	2.8362		2.8346	2.8364		2.8346	2.8358		2.8346	2.8353						
78	3.0709	3.0704	3.0721	3.0733		3.0713	3.0725		3.0709	3.0727		3.0709	3.0721		3.0709	3.0716						
80	3.1496	3.1491	3.1508	3.1520		3.1500	3.1512		3.1496	3.1514		3.1496	3.1508		3.1496	3.1503						
85	3.3465	3.3459	3.3479	3.3493		3.3470	3.3484		3.3465	3.3486		3.3465	3.3479		3.3465	3.3474						
90	3.5433	3.5427	3.5447	3.5461		3.5438	3.5452		3.5433	3.5454		3.5433	3.5447		3.5433	3.5442						
100	3.9370	3.9364	3.9384	3.9398	34L	3.9375	3.9389	25L	3.9370	3.9391	27L	3.9370	3.9384	20L	3.9370	3.9379	15L					
110	4.3307	4.3301	4.3321	4.3335	14L	4.3312	4.3326	5L	4.3307	4.3328	0	4.3307	4.3321	0	4.3307	4.3316	0					
115	4.5276	4.5270	4.5290	4.5304		4.5281	4.5295		4.5276	4.5297		4.5276	4.5290		4.5276	4.5285						
120	4.7244	4.7238	4.7258	4.7272		4.7249	4.7263		4.7244	4.7265		4.7244	4.7258		4.7244	4.7253						
125	4.9213	4.9206	4.9230	4.9246		4.9219	4.9234		4.9213	4.9238		4.9213	4.9229		4.9213	4.9223						
130	5.1181	5.1174	5.1198	5.1214		5.1187	5.1202		5.1181	5.1206		5.1181	5.1197		5.1181	5.1191						
135	5.3150	5.3143	5.3167	5.3183	40L	5.3156	5.3171	28L	5.3150	5.3175	32L	5.3150	5.3166	23L	5.3150	5.3160	17L					
140	5.5118	5.5111	5.5135	5.5151	17L	5.5124	5.5139	6L	5.5118	5.5143	0	5.5118	5.5134	0	5.5118	5.5128	0					
145	5.7087	5.7080	5.7104	5.7120		5.7093	5.7108		5.7087	5.7112		5.7087	5.7103		5.7087	5.7097						
150	5.9055	5.9048	5.9072	5.9088		5.9061	5.9076		5.9055	5.9080		5.9055	5.9071		5.9055	5.9065						
160	6.2992	6.2982	6.3009	6.3025		6.2998	6.3013		6.2992	6.3017		6.2992	6.3008		6.2992	6.3002						
170	6.6929	6.6919	6.6946	6.6962	43L	6.6935	6.6950	31L	6.6929	6.6954	35L	6.6929	6.6945	26L	6.6929	6.6939	20L					
180	7.0866	7.0856	7.0883	7.0899	17L	7.0872	7.0887	6L	7.0866	7.0891	0	7.0866	7.0882	0	7.0866	7.0876	0					
190	7.4803	7.4791	7.4823	7.4841		7.4809	7.4827		7.4803	7.4831		7.4803	7.4821		7.4803	7.4814						
200	7.8740	7.8728	7.8760	7.8778		7.8746	7.8764		7.8740	7.8768		7.8740	7.8758		7.8740	7.8751						
210	8.2677	8.2665	8.2697	8.2715		8.2683	8.2701		8.2677	8.2705		8.2677	8.2695		8.2677	8.2688						
215	8.4646	8.4634	8.4666	8.4684	50L	8.4652	8.4670	36L	8.4646	8.4674	40L	8.4646	8.4664	30L	8.4646	8.4657	23L					
225	8.8583	8.8571	8.8603	8.8621	20L	8.8589	8.8607	6L	8.8583	8.8611	0	8.8583	8.8601	0	8.8583	8.8594	0					
240	9.4488	9.4476	9.4508	9.4526		9.4494	9.4512		9.4488	9.4516		9.4488	9.4506		9.4488	9.4499						
250	9.8425	9.8413	9.8445	9.8463		9.8431	9.8449		9.8425	9.8453		9.8425	9.8443		9.8425	9.8436						
260	10.2362	10.2348	10.2384	10.2405		10.2369	10.2389		10.2362	10.2394		10.2362	10.2382		10.2362	10.2375						
270	10.6299	10.6285	10.6321	10.6342		10.6306	10.6326		10.6299	10.6331		10.6299	10.6319		10.6299	10.6312						
280	11.0236	11.0222	11.0258	11.0279	57L	11.0243	11.0263	41L	11.0236	11.0268	46L	11.0236	11.0256	34L	11.0236	11.0249	27L					
300	11.8110	11.8096	11.8132	11.8153	22L	11.8117	11.8137	7L	11.8110	11.8142	0	11.8110	11.8130	0	11.8110	11.8123	0					
310	12.2047	12.2033	12.2069	12.2090		12.2054	12.2074		12.2047	12.2079		12.2047	12.2067		12.2047	12.2060						
320	12.5984	12.5968	12.6008	12.6031		12.5991	12.6014		12.5984	12.6019		12.5984	12.6006		12.5984	12.5998						
340	13.3858	13.3842	13.3882	13.3905		13.3865	13.3888		13.3858	13.3893		13.3858	13.3880		13.3858	13.3872						
350	13.7795	13.7779	13.7819	13.7842	63L	13.7802	13.7825	46L	13.7795	13.7830	51L	13.7795	13.7817	38L	13.7795	13.7809	30L					
360	14.1732	14.1716	14.1756	14.1779	24L	14.1739	14.1762	7L	14.1732	14.1767	0	14.1732	14.1754	0	14.1732	14.1746	0					
380	14.9606	14.9590	14.9630	14.9653		14.9613	14.9636		14.9606	14.9641		14.9606	14.9628		14.9606	14.9620						
400	15.7480	15.7464	15.7504	15.7527		15.7487	15.7510		15.7480	15.7515		15.7480	15.7502		15.7480	15.7494						
420	16.5354	16.5336	16.5381	16.5406	70L	16.5362	16.5387	51L	16.5354	16.5392	56L	16.5354	16.5379	43L	16.5354	16.5370	34L					
440	17.3228	17.3210	17.3255	17.3280	27L	17.3236	17.3261	8L	17.3228	17.3266	0	17.3228	17.3253	0	17.3228	17.3244	0					
460	18.1102	18.1084	18.1129	18.1154		18.1110	18.1135		18.1102	18.1140		18.1102	18.1127		18.1102	18.1118						
480	18.8976	18.8958	18.9003	18.9028		18.8984	18.9009		18.8976	18.9014		18.8976	18.9001		18.8976	18.8992						
500	19.6850	19.6832	19.6877	19.6902		19.6858	19.6883		19.6850	19.6888		19.6850	19.6875		19.6850							

Housing Bearing-Seat Diameters (Values in Inches)

mm	Bearing Outside Diameter		J6				J7				K6				K7				M6			
	Inches		Housing Bore		Fit in 0.0001*	Housing Bore		Fit in 0.0001*	Housing Bore		Fit in 0.0001*	Housing Bore		Fit in 0.0001*	Housing Bore		Fit in 0.0001*	Housing Bore		Fit in 0.0001*		
	Max	Min.	Max.	Min.		Max.	Min.		Max.	Min.		Max.	Min.		Max.	Min.		Max.	Min.		Max.	Min.
16	0.6299	0.6296	0.6297	0.6301	5L 2T	0.6296	0.6303	7L 3T	0.6295	0.6300	4L 4T	0.6294	0.6301	5L 5T	0.6293	0.6297	1L 6T					
19	0.7480	0.7476	0.7478	0.7483	7L 2T	0.7476	0.7485	9L 4T	0.7476	0.7481	4L 4T	0.7474	0.7482	5L 5T	0.7473	0.7478	6L 6T	0.7473	0.7478	7L 7T		
21	0.8268	0.8264	0.8266	0.8271		0.8264	0.8273		0.8264	0.8269		0.8262	0.8270		0.8262	0.8270		0.8261	0.8266			
22	0.8661	0.8657	0.8659	0.8664		0.8657	0.8666		0.8657	0.8662		0.8655	0.8663		0.8655	0.8663		0.8654	0.8659			
24	0.9449	0.9445	0.9447	0.9452		0.9445	0.9454		0.9445	0.9450		0.9443	0.9451		0.9443	0.9451		0.9442	0.9447			
26	1.0236	1.0232	1.0234	1.0239		1.0232	1.0241		1.0232	1.0237		1.0230	1.0238		1.0230	1.0238		1.0229	1.0234			
28	1.1024	1.1020	1.1022	1.1027	1.1020	1.1029	1.1020	1.1025	1.1018	1.1026	1.1018	1.1026	1.1017	1.1022								
30	1.1811	1.1807	1.1809	1.1814	1.1807	1.1816	1.1807	1.1812	1.1805	1.1813	1.1805	1.1813	1.1804	1.1809								
32	1.2598	1.2594	1.2596	1.2602	8L 2T	1.2594	1.2604	10L 4T	1.2593	1.2599	5L 5T	1.2591	1.2601	7L 7T	1.2590	1.2600	8L 8T	1.2590	1.2600	9L 9T		
35	1.3780	1.3776	1.3778	1.3784		1.3776	1.3786		1.3776	1.3781		1.3773	1.3783		1.3773	1.3783		1.3772	1.3778			
37	1.4567	1.4563	1.4565	1.4571		1.4563	1.4573		1.4563	1.4568		1.4560	1.4570		1.4560	1.4570		1.4559	1.4565			
40	1.5748	1.5744	1.5746	1.5752		1.5744	1.5754		1.5744	1.5749		1.5741	1.5751		1.5741	1.5751		1.5740	1.5746			
42	1.6535	1.6531	1.6533	1.6539		1.6531	1.6541		1.6530	1.6536		1.6528	1.6538		1.6528	1.6538		1.6527	1.6533			
44	1.8504	1.8500	1.8502	1.8508	1.8500	1.8510	1.8500	1.8505	1.8497	1.8507	1.8497	1.8507	1.8496	1.8502								
52	2.0472	2.0467	2.0470	2.0477	10L 2T	2.0467	2.0479	12L 5T	2.0466	2.0474	6L 6T	2.0464	2.0476	8L 8T	2.0463	2.0470	9L 9T	2.0463	2.0470	10L 10T		
55	2.1654	2.1649	2.1652	2.1659		2.1649	2.1661		2.1649	2.1656		2.1646	2.1658		2.1646	2.1658		2.1645	2.1652			
58	2.2835	2.2830	2.2833	2.2840		2.2830	2.2842		2.2829	2.2837		2.2827	2.2839		2.2827	2.2839		2.2826	2.2833			
62	2.4409	2.4404	2.4407	2.4414		2.4404	2.4416		2.4403	2.4411		2.4401	2.4413		2.4401	2.4413		2.4400	2.4407			
65	2.5591	2.5586	2.5589	2.5596		2.5586	2.5598		2.5585	2.5593		2.5575	2.5595		2.5575	2.5595		2.5582	2.5589			
70	2.7559	2.7554	2.7557	2.7564	2.7554	2.7566	2.7553	2.7561	2.7551	2.7563	2.7551	2.7563	2.7550	2.7557								
72	2.8346	2.8341	2.8344	2.8351	2.8344	2.8353	2.8340	2.8348	2.8338	2.8350	2.8338	2.8350	2.8337	2.8344								
78	3.0709	3.0704	3.0707	3.0714	3.0704	3.0716	3.0703	3.0711	3.0701	3.0713	3.0701	3.0713	3.0700	3.0707								
80	3.1496	3.1491	3.1494	3.1501	3.1491	3.1503	3.1490	3.1498	3.1488	3.1500	3.1488	3.1500	3.1487	3.1494								
85	3.3465	3.3459	3.3463	3.3471	12L 2T	3.3460	3.3474	15L 5T	3.3458	3.3467	8L 7T	3.3455	3.3469	10L 10T	3.3454	3.3463	11L 11T	3.3454	3.3463	12L 12T		
90	3.5433	3.5427	3.5431	3.5439		3.5428	3.5442		3.5426	3.5435		3.5423	3.5437		3.5423	3.5437		3.5422	3.5431			
100	3.9370	3.9364	3.9368	3.9376		3.9365	3.9379		3.9363	3.9372		3.9360	3.9374		3.9360	3.9374		3.9359	3.9368			
110	4.3307	4.3301	4.3305	4.3313		4.3302	4.3316		4.3300	4.3309		4.3297	4.3311		4.3297	4.3311		4.3296	4.3305			
115	4.5276	4.5270	4.5274	4.5282		4.5271	4.5285		4.5269	4.5278		4.5266	4.5280		4.5266	4.5280		4.5265	4.5274			
120	4.7244	4.7238	4.7242	4.7250	4.7239	4.7253	4.7237	4.7246	4.7234	4.7248	4.7234	4.7248	4.7233	4.7242								
125	4.9213	4.9206	4.9210	4.9220	14L 3T	4.9207	4.9223	17L 6T	4.9205	4.9215	9L 8T	4.9202	4.9218	12L 11T	4.9200	4.9210	13L 13T	4.9200	4.9210	14L 14T		
130	5.1181	5.1174	5.1178	5.1188		5.1175	5.1191		5.1173	5.1183		5.1170	5.1186		5.1170	5.1186		5.1168	5.1178			
135	5.3150	5.3143	5.3147	5.3157		5.3144	5.3160		5.3142	5.3152		5.3139	5.3155		5.3139	5.3155		5.3137	5.3147			
140	5.5118	5.5111	5.5115	5.5125		5.5112	5.5128		5.5110	5.5120		5.5107	5.5123		5.5107	5.5123		5.5105	5.5115			
145	5.7087	5.7080	5.7084	5.7094		5.7081	5.7097		5.7079	5.7089		5.7076	5.7092		5.7076	5.7092		5.7074	5.7084			
150	5.9055	5.9048	5.9052	5.9062	5.9049	5.9065	5.9047	5.9057	5.9044	5.9060	5.9044	5.9060	5.9042	5.9052								
160	6.2992	6.2986	6.2989	6.2999	17L 3T	6.2986	6.3002	20L 6T	6.2984	6.2994	12L 8T	6.2981	6.2997	15L 11T	6.2979	6.2989	16L 13T	6.2979	6.2989	17L 14T		
170	6.6929	6.6919	6.6926	6.6936		6.6923	6.6939		6.6921	6.6931		6.6918	6.6934		6.6918	6.6934		6.6916	6.6926			
180	7.0866	7.0856	7.0863	7.0873		7.0860	7.0876		7.0858	7.0868		7.0855	7.0871		7.0855	7.0871		7.0853	7.0863			
190	7.4803	7.4791	7.4800	7.4812		7.4797	7.4815		7.4794	7.4805		7.4790	7.4808		7.4790	7.4808		7.4788	7.4800			
200	7.8740	7.8728	7.8737	7.8749		7.8734	7.8752		7.8731	7.8742		7.8727	7.8745		7.8727	7.8745		7.8725	7.8737			
210	8.2677	8.2665	8.2674	8.2686	8.2671	8.2689	8.2668	8.2679	8.2664	8.2682	8.2664	8.2682	8.2662	8.2674								
215	8.4646	8.4634	8.4643	8.4655	8.4640	8.4658	8.4637	8.4648	8.4633	8.4651	8.4633	8.4651	8.4631	8.4643								
225	8.8583	8.8571	8.8580	8.8592	8.8577	8.8595	8.8574	8.8585	8.8570	8.8588	8.8570	8.8588	8.8568	8.8580								
240	9.4488	9.4476	9.4485	9.4497	9.4482	9.4500	9.4479	9.4490	9.4475	9.4493	9.4475	9.4493	9.4473	9.4485								
250	9.8425	9.8413	9.8422	9.8434	9.8419	9.8437	9.8416	9.8427	9.8412	9.8430	9.8412	9.8430	9.8410	9.8422								
260	10.2362	10.2348	10.2356	10.2372	24L 3T	10.2356	10.2376	28L 6T	10.2351	10.2364	16L 11T	10.2348	10.2368	20L 14T	10.2346	10.2358	24L 17T	10.2346	10.2358	25L 18T		
270	10.6299	10.6285	10.6296	10.6309		10.6293	10.6313		10.6288	10.6301		10.6285	10.6305		10.6285	10.6305		10.6283	10.6295			
280	11.0236	11.0222	11.0233	11.0246		11.0230	11.0250		11.0225	11.0238		11.0222	11.0242		11.0222	11.0242		11.0220	11.0232			
300	11.8110	11.8096	11.8107	11.8120		11.8104	11.8124		11.8099	11.8112		11.8096	11.8116		11.8096	11.8116		11.8094	11.8106			
310	12.2047	12.2033	12.2044	12.2057		12.2041	12.2061		12.2036	12.2049		12.2033	12.2053		12.2033	12.2053		12.2031	12.2043			
320	12.5984	12.5968	12.5981	12.5995	27L 3T	12.5977	12.5999	31L 7T	12.5973	12.5987	19L 11T	12.5968	12.5991	23L 16T	12.5966	12.5980	27L 18T	12.5966	12.5980	28L 19T		
340	13.3858	13.3842	13.3855	13.3869		13.3851	13.3873		13.3847	13.3861		13.3842	13.3865		13.3842	13.3865		13.3840	13.3854			
350	13.7795	13.7779	13.7792	13.7806		13.7788	13.7810		13.7784	13.7798		13.7779	13.7802		13.7779	13.7802		13.7777	13.7791			
360	14.1732	14.1716	14.1729	14.1743		14.1725	14.1747		14.1721	14.1735		14.1716	14.1739		14.1716	14.1739		14.1714	14.1728			
380	14.9606	14.9590	14.9603	14.9617		14.9599	14.9621		14.9595	14.9609		14.9590	14.9613		14.9590	14.9613		14.9588	14.9602			
400	15.7480	15.7464	15.7477	15.7491	15.7473	15.7495	15.7469	15.7483	15.7464	15.7487	15.7464	15.7487	15.7462	15.7476								
420	16.5354	16.5336	16.5351	16.5367	31L 3T	16.5346	16.5371	35L 8T	16.5341	16.5357	21L 13T	16.5336	16.5361	25L 18T	16.5334	16.5350	29L 20T	16.5334	16.5350	30L 21T		
440	17.3228	17.3210	17.3225	17.3241		17.3220	17.3245		17.3215	17.3231		17.3210	17.3235		17.3210	17.3235		17.3208	17.3224			
460	18.1102	18.1084	18.1099	18.1115																		

Shaft Bearing-Seat Diameters (Values in Inches)

Bearing Outside Diameter	M7			N6			N7			P6			P7							
	Housing Bore		Fit in 0.0000*	Housing Bore		Fit in 0.0000*	Housing Bore		Fit in 0.0000*	Housing Bore		Fit in 0.0000*	Housing Bore		Fit in 0.0000*					
	Max.	Min.		Max.	Min.		Max.	Min.		Max.	Min.		Max.	Min.						
16	0.6292	0.6299	3L 7T	0.6291	0.6295	1T 8T	0.6290	0.6297	1L 9T	0.6289	0.6293	3T 10T	0.6288	0.6295	1T 11T					
19	0.7472	0.7480	4L 8T	0.7471	0.7476	0 9T	0.7469	0.7477	1L 11T	0.7468	0.7473	3T 12T	0.7466	0.7474	2T 14T					
21	0.8260	0.8268		0.8259	0.8264		0.8258	0.8265		0.8261	0.8256		0.8262							
22	0.8653	0.8661		0.8652	0.8657		0.8650	0.8658		0.8649	0.8654		0.8647	0.8655						
24	0.9441	0.9449		0.9440	0.9445		0.9438	0.9446		0.9437	0.9442		0.9435	0.9443						
26	1.0228	1.0236		1.0227	1.0232		1.0225	1.0233		1.0224	1.0229		1.0232	1.0230						
28	1.1016	1.1024	1.1015	1.1020	1.1013	1.1021	1.1012	1.1017	1.1010	1.1018										
30	1.1803	1.1811	1.1802	1.1807	1.1800	1.1808	1.1799	1.1804	1.1797	1.1805										
32	1.2588	1.2598	4L 10T	1.2587	1.2593	1T 11T	1.2585	1.2595	1L 13T	1.2583	1.2590	4T 15T	1.2581	1.2591	3T 17T					
35	1.3770	1.3780		1.3769	1.3775		1.3767	1.3777		1.3765	1.3772		1.3763	1.3773						
37	1.4557	1.4567		1.4556	1.4562		1.4548	1.4564		1.4552	1.4559		1.4550	1.4560						
40	1.5738	1.5748		1.5737	1.5743		1.5735	1.5745		1.5733	1.5740		1.5731	1.5741						
42	1.6525	1.6535		1.6524	1.6530		1.6522	1.6532		1.6520	1.6527		1.6518	1.6528						
44	1.7312	1.7322		1.7311	1.7317		1.7303	1.7319		1.7301	1.7308		1.7300	1.7310						
47	1.8494	1.8504		1.8493	1.8499		1.8489	1.8501		1.8489	1.8496		1.8487	1.8497						
52	2.0460	2.0472	5L 12T	2.0459	2.0466	1T 13T	2.0457	2.0468	1L 15T	2.0454	2.0462	5T 18T	2.0452	2.0464	3T 20T					
55	2.1642	2.1654		2.1641	2.1648		2.1639	2.1650		2.1636	2.1644		2.1634	2.1646						
58	2.2823	2.2835		2.2822	2.2829		2.2820	2.2831		2.2817	2.2825		2.2815	2.2827						
62	2.4397	2.4409		2.4396	2.4403		2.4394	2.4405		2.4391	2.4399		2.4389	2.4401						
65	2.5579	2.5591		2.5578	2.5585		2.5576	2.5587		2.5573	2.5581		2.5571	2.5583						
70	2.7547	2.7559		2.7546	2.7553		2.7544	2.7555		2.7541	2.7549		2.7539	2.7551						
72	2.8334	2.8346		2.8333	2.8340		2.8331	2.8342		2.8328	2.8336		2.8326	2.8338						
78	3.0697	3.0709		3.0696	3.0703		3.0694	3.0705		3.0691	3.0699		3.0689	3.0701						
80	3.1484	3.1496		3.1483	3.1490		3.1481	3.1492		3.1478	3.1486		3.1476	3.1488						
85	3.3451	3.3465		6L 14T	3.3450		3.3459	0 15T		3.3447	3.3461		2L 18T	3.3445		3.3453	6T 20T	3.3442	3.3456	3T 23T
90	3.5419	3.5433	3.5418		3.5427	3.5415	3.5429		3.5413	3.5421	3.5410	3.5424								
100	3.9356	3.9370	3.9355		3.9364	3.9352	3.9366		3.9350	3.9358	3.9347	3.9361								
110	4.3293	4.3307	4.3292		4.3301	4.3289	4.3303		4.3287	4.3295	4.3284	4.3298								
115	4.5262	4.5276	4.5261		4.5270	4.5258	4.5272		4.5256	4.5264	4.5253	4.5267								
120	4.7230	4.7244	4.7229		4.7238	4.7226	4.7240		4.7224	4.7232	4.7221	4.7235								
125	4.9197	4.9213	7L 16T	4.9195	4.9205	1T 18T	4.9193	4.9208	2L 20T	4.9189	4.9199	7T 24T	4.9186	4.9202	4T 27T					
130	5.1165	5.1181		5.1163	5.1173		5.1161	5.1176		5.1157	5.1167		5.1154	5.1170						
135	5.3134	5.3150		5.3132	5.3142		5.3130	5.3145		5.3126	5.3136		5.3123	5.3139						
140	5.5102	5.5118		5.5100	5.5110		5.5098	5.5113		5.5094	5.5104		5.5091	5.5107						
145	5.7071	5.7087		5.7069	5.7079		5.7067	5.7082		5.7063	5.7073		5.7060	5.7076						
150	5.9039	5.9055		5.9037	5.9047		5.9035	5.9050		5.9031	5.9041		5.9028	5.9044						
160	6.2976	6.2992		10L 16T	6.2974		6.2984	2L 18T		6.2972	6.2987		5L 20T	6.2968		6.2978	4T 24T	6.2965	6.2981	1T 27T
170	6.6913	6.6929	6.6911		6.6921	6.6909	6.6924		6.6905	6.6915	6.6902	6.6918								
180	7.0850	7.0866	7.0848		7.0858	7.0846	7.0861		7.0842	7.0852	7.0839	7.0855								
190	7.4785	7.4803	12L 18T	7.4783	7.4794	3L 20T	7.4779	7.4797	6L 24T	7.4775	7.4787	4T 28T	7.4772	7.4789	1T 31T					
200	7.8722	7.8740		7.8720	7.8731		7.8716	7.8734		7.8712	7.8724		7.8709	7.8727						
210	8.2659	8.2677		8.2657	8.2668		8.2653	8.2671		8.2649	8.2661		8.2646	8.2664						
215	8.4628	8.4646		8.4626	8.4637		8.4622	8.4640		8.4618	8.4630		8.4615	8.4633						
225	8.8565	8.8583		8.8563	8.8574		8.8559	8.8577		8.8555	8.8567		8.8552	8.8570						
240	9.4470	9.4488		9.4468	9.4479		9.4464	9.4482		9.4460	9.4472		9.4457	9.4475						
250	9.8407	9.8425		9.8405	9.8416		9.8401	9.8419		9.8397	9.8409		9.8394	9.8412						
260	10.2342	10.2362		14L 20T	10.2340		10.2352	4L 22T		10.2336	10.2356		8L 26T	10.2331		10.2343	5T 31T	10.2327	10.2348	0 35T
270	10.6279	10.6299			10.6277		10.6289			10.6273	10.6293			10.6268		10.6280		10.6264	10.6285	
280	11.0216	11.0236			11.0214		11.0226			11.0210	11.0230			11.0205		11.0220		11.0201	11.0222	
300	11.8090	11.8110	11.8088		11.8100	11.8084	11.8104		11.8079	11.8091	11.8075	11.8096								
310	12.2027	12.2047	12.2025		12.2037	12.2021	12.2041		12.2016	12.2028	12.2012	12.2033								
320	12.5962	12.5984	16L 22T		12.5960	12.5974	6L 24T		12.5955	12.5978	10L 29T	12.5950		12.5964	4T 34T	12.5945		12.5968	0 39T	
340	12.3836	12.3858		12.3834	12.3848	12.3829		12.3852	12.3824	12.3838		12.3819	12.3842							
350	13.7773	13.7795		13.7771	13.7785	13.7766		13.7789	13.7761	13.7775		13.7756	13.7779							
360	14.1710	14.1732		14.1708	14.1722	14.1703		14.1726	14.1698	14.1712		14.1693	14.1716							
380	14.9584	14.9606		14.9582	14.9596	14.9577		14.9600	14.9572	14.9586		14.9567	14.9590							
400	15.7458	15.7480		15.7456	15.7470	15.7451		15.7474	15.7446	15.7460		15.7441	15.7464							
420	16.5329	16.5354		18L 25T	16.5328	16.5343		7L 26T	16.5323	16.5347		11L 31T	16.5317	16.5332		4T 37T	16.5311	16.5336		0 43T
440	17.3203	17.3228	17.3202		17.3217	17.3197	17.3221		17.3191	17.3206	17.3185		17.3210							
460	18.1077	18.1102	18.1076		18.1091	18.1071	18.1095		18.1065	18.1080	18.1059		18.1084							
480	18.8951	18.8976	18.8950		18.8965	18.8945	18.8969		18.8939	18.8954	18.8933		18.8958							
500	19.6825	19.6850	19.6824		19.6839	19.6819	19.6843		19.6813	19.6828	19.6807		19.6832							
520	20.4686	20.4714	10L 38T	20.4689	20.4707	3L 35T	20.4679	20.4707	4L 45T	20.4676	20.4693	11T 48T	20.4666	20.4693	11T 58T					
540	21.2560	21.2588		21.2563	21.2581		21.2553	21.2581		21.2550	21.2567		21.2540	21.2567						
560	22.0434	22.0462		22.0437	22.0455		22.0427	22.0455		22.0424	22.0441		22.0414	22.0441						
580	22.8308	22.8336		22.8311	22.8329		22.8301	22.8329		22.8298	22.8315		22.8288	22.8315						
600	23.6182	23.6210		23.6185	23.6203		23.6175	23.6203		23.6172	23.6189		23.6162	23.6189						
620	24.4056	24.4084		24.4059	24.4077		24.4049	24.4077		24.4046	24.4063		24.4036	24.4063						
650	25.5863	25.5894		18L 43T	25.5867		25.5886	10L 39T		25.5855	25.5886		10L 51T	25.5852		25.5871	5T 54T	25.5840	25.5871	5T 66T
670	26.3737	26.3768	26.3741		26.3760	26.3729	26.3760		26.3726	26.3745	26.3714	26.3745								
680	26.7674	26.7705	26.7678		26.7697	26.7666	26.7697		26.7663	26.7682	26.7651	26.7682								
700	27.5548	27.5579	27.5552		27.5571	27.5540	27.5571		27.5537	27.5556	27.5525	27.5556								
720	28.3422	28.3453	28.3426		28.3445	28.3414	28.3445		28.3411	28.3430	28.3399	28.3430								
750	29.5233	29.5264	29.5237		29.5256	29.5225	29.5256		29.5222	29.5241	29.5210	29.5241								
780	30.7044	30.7075	30.7048		30.7067	30.7036	30.7067		30.7033	30.7052	30.7021	30.7052								
790	31.0981	31.1012	31.0985		31.1004	31.0973	31.1004		31.0970	31.0989	31.0958	31.0989								
820	32.2786	32.2822	26L 49T		32.2791	32.2813	17L 44T		32.2778	32.2813	17L 57T	32.2774		32.2796	0 61T	32.2760		32.2796	0 7	

Internal Radial Clearance Tolerances for Single-Row Ball Bearings

MRC Bearing Services

ABMA tolerances are listed up to and including 200 mm.

MRC tolerances are listed from 200 mm up to and including 500 mm.

Tolerance limits are listed in ten thousandths inches (.0001") and micrometers (µm).

Axial and radial clearance for double row bearings is shown on page 145

Bore Over mm		Including mm		Bearing Series		ABMA C2		C0		C3		C4	
				Inch Sizes R, XLS	Metric Sizes 30, 100K, 200, 300, 400, 1900	MRC TI in	(µm)	ST in	(µm)	LO in	(µm)	XL in	(µm)
2.5	—	10	—	—	34-39	0-3	0-8	1-5	3-13	3-9	8-23	6-12*	15-30*
2.5	.0984	10	.3937	R2-R6	00	0-3	0-8	1-5	3-13	3-9	8-23	6-12*	15-30*
10	.3937	18	.7087	R8-R10	01-03	0-3.5	0-9	1-7	3-18	4-10	10-25	7-13	18-33
18	.7087	24	.9449	R12-R14	04	0-4	0-10	2-8	5-20	5-11	13-28	8-14	20-36
24	.9449	30	1.1811	R16-R18	05-06	0-4.5	0-11	2-8	5-20	5-11	13-28	9-16	23-41
30	1.1811	40	1.5748	R20	07-08	0-4.5	0-11	2-8	5-20	6-13	15-33	11-18	28-46
—	1.1811	—	1.5748	1 ⁵ / ₈ -1 ¹ / ₂	—	0-4.5	0-11	2-8	5-20	6-13	15-33	11-18	28-46
40	1.5748	50	1.9665	1 ⁵ / ₈ -1 ⁷ / ₈	09-10	0-4.5	0-11	2-9	5-23	7-14	18-36	12-20	30-51
50	1.9685	65	2.5591	2-2 ¹ / ₂	11-13	0-6	0-15	3-11	8-28	9-17	23-43	15-24	38-61
65	2.5591	80	3.1496	2 ⁵ / ₈ -3 ¹ / ₈	14-16	0-6	0-15	4-12	10-30	10-20	25-51	18-28	45-71
80	3.1496	100	3.9370	3 ¹ / ₄ -3 ³ / ₈	17-20	0-7	0-18	5-14	13-36	12-23	30-58	21-33	53-64
100	3.9370	120	4.7244	4-4 ⁵ / ₈	21-24	0-8	0-20	6-16	15-41	14-26	36-66	24-38	61-97
120	4.7244	140	5.5118	4 ³ / ₄ -5 ¹ / ₂	26-28	0-9	0-23	7-19	18-48	16-32	41-81	28-45	71-114
140	5.5118	160	6.2992	5 ³ / ₈ -6 ¹ / ₄	30-32	0-9	0-23	7-21	18-53	18-36	46-91	32-51	81-130
160	6.2992	180	7.0866	6 ¹ / ₂ -7	34-36	0-10	0-25	8-24	20-61	21-40	53-102	36-58	91-147
180	7.0866	200	7.8740	7 ¹ / ₄ -7 ³ / ₄	38-40	0-12	0-30	10-28	25-71	25-46	64-117	42-64	107-163
200	7.8740	220	8.6614	8-8 ¹ / ₂	42-44	0-12	0-30	12-30	30-76	29-50	74-127	47-69	119-175
220	8.6614	240	9.4488	8 ³ / ₄ -9	46-48	1-13	3-33	15-33	38-84	35-56	89-142	55-77	140-196
240	9.4485	260	10.2362	9 ¹ / ₂ -10	50-52	2-14	5-36	18-36	45-91	42-63	107-160	64-86	163-218
260	10.2352	280	11.0236	10 ¹ / ₂ -11	56	2-14	5-36	21-39	53-99	49-70	124-178	74-96	188-244
280	11.0236	300	11.8110	11 ¹ / ₂	60	3-15	8-38	25-43	64-109	57-78	145-198	85-107	216-272
300	11.8110	320	12.5984	12	64	4-16	10-41	29-47	74-119	67-88	107-223	98-120	249-304
320	12.5984	340	13.3858	—	—	4-16	10-41	33-51	84-130	78-99	198-251	113-135	287-343
340	13.3858	360	14.1732	—	—	5-17	13-43	38-56	96-142	91-112	231-284	129-151	327-384
360	14.1732	380	14.9606	—	—	6-18	15-46	43-61	109-155	106-127	269-323	149-171	378-434
380	14.9606	400	15.7480	—	—	7-19	18-48	48-66	122-168	126-147	320-373	169-191	429-485
400	15.7480	420	16.5354	—	—	7-19	18-48	54-72	137-183	148-169	376-429	193-215	490-546
420	16.5354	440	17.3223	—	—	8-20	20-51	60-78	152-198	173-194	439-493	220-242	559-615
440	17.3223	460	18.1102	—	—	9-21	23-53	67-85	170-216	202-223	513-566	251-273	638-693
460	18.1106	480	18.8976	—	—	10-22	25-56	74-92	188-234	234-255	594-648	285-307	724-780
480	18.8976	500	19.6850	—	—	12-24	30-61	82-100	208-254	269-290	683-737	326-348	828-884

*Not ABMA Value

Definition of Dynamic and Static Radial Load Ratings

The size of a bearing to be used for an application is initially selected on the basis of its load carrying capacity in relation to the loads to be carried and the requirements regarding life and reliability. Numerical values of basic load ratings are used in calculations to express load carrying capacity. The basic dynamic load rating C and the basic static load rating C_0 are quoted in the bearing tables. All values expressed are radial ratings.

Dynamic Radial Load Rating

The basic dynamic load rating C is used for calculations involving the selection of bearings which rotate under load. It expresses the bearing radial load which will give a basic rating life of one million revolutions. The actual calculated life depends on the magnitude of the imposed load. The imposed load produces rolling element and raceway deformation as illustrated in figure 1, resulting in tensile (t) and compressive (c) stresses as each rolling element passes through the loaded zone. As these stress cycles are repeated, as determined by the number of revolutions of calculated life, sub-surface metal fatigue cracks occur which eventually propagate to the raceway surface causing metal flaking, or spalling, at which time the bearing has achieved its useful life.

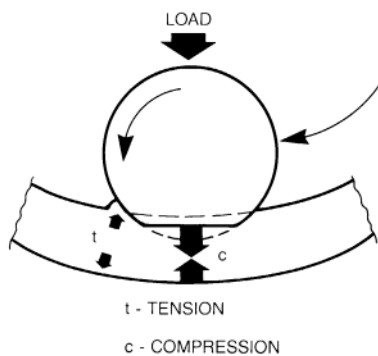

Figure 1

The basic dynamic radial load ratings of MRC Bearings have been determined in accordance with the latest ISO and ABMA standards and are based on the material and manufacturing techniques used for MRC standard production. They apply to radial loads acting on radial and angular contact bearings which are constant in magnitude and direction. For single row angular contact bearings, the radial load rating refers to the radial component of that load which causes a purely radial displacement of the bearing rings in relation to each other.

Static Radial Load Rating

The basic static radial load rating C_0 is used when bearings rotate at very slow speeds, are subjected to very slow oscillations, or stationary under load. It also must be considered when heavy shock loads of short duration act on a rotating bearing.

The basic static radial load rating is defined in accordance with ISO and ABMA standards as the static radial load which corresponds to a calculated contact stress at the center of the most heavily loaded rolling element/raceway contact of 609000 PSI for all radial and angular contact ball bearings. For this contact stress, a total permanent deformation of rolling element and raceway occurs which is approximately 0.0001 of the rolling element diameter as shown in figure 2.

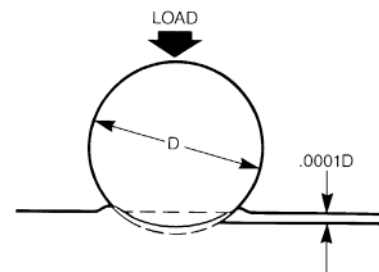

Figure 2

Definition of Bearing Life

The life of a rolling bearing is defined as the number of revolutions or the number of hours at a given speed which the bearing is capable of enduring before the first sign of fatigue failure occurs on one of its rings or rolling elements.

The fatigue failure usually takes the form of surface spalling or flaking which progresses to the point where the bearing become inoperative. The load ratings shown in this catalog are based on the useful life of a bearing as limited by this type of failure.

When a group of identical bearings are run under a set condition of speed and load, there will be considerable variation in the fatigue lives in the group. As a result, life must be treated statistically.

The life which 90% of a group of bearings will exceed is known as the "minimum life" or "rating life". A commonly used term as used in this catalog is "L10". The life which 50% of a group of bearings will exceed is the "median life" (L50) and is approximately five times the "minimum life".

The actual life of a specific bearing is referred to as "service life" and unlike "minimum" or "rating" life, is not generated by fatigue. It is the result of contamination, corrosion, misalignment, etc., significantly reducing life.

Life Adjustment Factor for Reliability, a_1

To determine bearing life in accordance with reliability greater than 90%, the L10 life must be multiplied by the factor a_1 as shown in the table below.

Life Adjustment Factor for Reliability, a_1		
Reliability %	L_{ma}	a_1
90	L_{10}	1
95	L_5	0.62
96	L_4	0.53
97	L_3	0.44
98	L_2	0.33
99	L_1	0.21

When bearings are stationary, rotate or oscillate very slowly or subjected to heavy shock loads, the basic static load rating (C_0) must not be exceeded. As specified in ABMA and ISO standards, the static load rating is that load which produces a total permanent deformation of the rolling element or raceway which is approximately 0.0001 of the rolling element diameter. Deformation greater than this amount may result in noisy operation and premature failure.

Determination of Bearing Life

Bearing "rating life" can be calculated by referring to the procedure and examples located at the back of each bearing section. Both Dynamic (C) and static (C_0) load ratings are listed on the preceding pages. The load ratings and life calculation method agree with ABMA and ISO standards, with the exception of Mast Guide and PumPac bearings. The rating of these bearings has been modified to reflect raceway curvatures less than a total of 54 percent.

The speed factors shown in the table below are used to convert the basic dynamic radial load rating (C) to speeds other than 33 1/3 RPM, by multiplying C by the speed factor. The values of C are listed in the bearing dimension tables.

For speed factors at speeds not shown, use the following formula:

$$\text{Speed Factor} = 3.218 \left(\frac{1}{n}\right)^{1/3}$$

where n = operating RPM

Example:

Find dynamic radial load rating of 309S bearing at 2000 RPM

Basic dynamic radial loading rating (C) = 11900 Lbs.

Speed factor at 2000 RPM = .255

Rating at 2000 RPM = 11900 × .255 = 3035

RPM	Factor	RPM	Factor	RPM	Factor	RPM	Factor	RPM	Factor	RPM	Factor	RPM	Factor
35	.9838	420	.4297	870	.3371	1 640	.2729	2 600	.2340	6 100	.1761	16 000	.1277
40	.9409	430	.4263	880	.3358	1 660	.2718	2 650	.2325	6 200	.1752	17 000	.1252
45	.9047	440	.4231	890	.3345	1 680	.2707	2 700	.2311	6 300	.1742	18 000	.1228
50	.8735	450	.4199	900	.3333	1 700	.2696	2 750	.2297	6 400	.1733	19 000	.1206
55	.8462	460	.4169	910	.3321	1 720	.2686	2 800	.2283	6 500	.1724	20 000	.1186
60	.8220	470	.4139	920	.3309	1 740	.2675	2 850	.2270	6 600	.1716	21 000	.1166
65	.8004	480	.4110	930	.3297	1 760	.2665	2 900	.2257	6 700	.1707	22 000	.1148
70	.7808	490	.4082	940	.3285	1 780	.2655	2 950	.2244	6 800	.1699	23 000	.1132
75	.7631	500	.4054	950	.3273	1 800	.2645	3 000	.2231	6 900	.1690	24 000	.1116
80	.7468	510	.4028	960	.3262	1 820	.2636	3 050	.2219	7 000	.1682	25 000	.1101
85	.7319	520	.4002	970	.3251	1 840	.2626	3 100	.2207	7 100	.1674	26 000	.1086
90	.7181	530	.3976	980	.3240	1 860	.2617	3 150	.2195	7 200	.1667	27 000	.1073
95	.7053	540	.3952	990	.3229	1 880	.2607	3 200	.2184	7 300	.1659	28 000	.1060
100	.6933	550	.3928	1 000	.3218	1 900	.2598	3 250	.2172	7 400	.1651	29 000	.1047
110	.6716	560	.3904	1 020	.3197	1 920	.2589	3 300	.2161	7 500	.1644	30 000	.1036
120	.6524	570	.3881	1 040	.3176	1 940	.2580	3 350	.2151	7 600	.1637	31 000	.1024
130	.6352	580	.3859	1 060	.3156	1 960	.2571	3 400	.2140	7 700	.1630	32 000	.1014
140	.6197	590	.3837	1 080	.3136	1 980	.2563	3 450	.2130	7 800	.1623	33 000	.1003
150	.6057	600	.3815	1 100	.3117	2 000	.2554	3 500	.2119	7 900	.1616	34 000	.0993
160	.5928	610	.3794	1 120	.3098	2 020	.2546	3 550	.2109	8 000	.1609	35 000	.0984
170	.5809	620	.3774	1 140	.3080	2 040	.2537	3 600	.2100	8 100	.1602	40 000	.0941
180	.5699	630	.3754	1 160	.3063	2 060	.2529	3 700	.2081	8 200	.1596	45 000	.0905
190	.5598	640	.3734	1 180	.3045	2 080	.2521	3 800	.2062	8 300	.1589	50 000	.0873
200	.5503	650	.3715	1 200	.3028	2 100	.2513	3 900	.2044	8 400	.1583	55 000	.0846
210	.5414	660	.3696	1 220	.3012	2 120	.2505	4 000	.2027	8 500	.1577	60 000	.0822
220	.5331	670	.3678	1 240	.2995	2 140	.2497	4 100	.2011	8 600	.1571	70 000	.0781
230	.5252	680	.3659	1 260	.2979	2 160	.2489	4 200	.1995	8 700	.1565	80 000	.0747
240	.5178	690	.3642	1 280	.2964	2 180	.2482	4 300	.1979	8 800	.1559	90 000	.0718
250	.5108	700	.3624	1 300	.2949	2 200	.2474	4 400	.1964	8 900	.1552	100 000	.0693
260	.5042	710	.3607	1 320	.2934	2 220	.2467	4 500	.1949	9 000	.1547		
270	.4979	720	.3590	1 340	.2919	2 240	.2459	4 600	.1935	9 100	.1541		
280	.4919	730	.3574	1 360	.2905	2 260	.2452	4 700	.1921	9 200	.1536		
290	.4862	740	.3558	1 380	.2890	2 280	.2445	4 800	.1908	9 300	.1530		
300	.4807	750	.3542	1 400	.2877	2 300	.2438	4 900	.1895	9 400	.1525		
310	.4755	760	.3526	1 420	.2863	2 320	.2431	5 000	.1882	9 500	.1519		
320	.4705	770	.3511	1 440	.2850	2 340	.2424	5 100	.1870	9 600	.1514		
330	.4657	780	.3496	1 460	.2837	2 360	.2417	5 200	.1857	9 700	.1509		
340	.4611	790	.3481	1 480	.2824	2 380	.2410	5 300	.1846	9 800	.1504		
350	.4566	800	.3466	1 500	.2811	2 400	.2404	5 400	.1834	9 900	.1499		
360	.4524	810	.3452	1 520	.2799	2 420	.2397	5 500	.1823	10 000	.1494		
370	.4482	820	.3438	1 540	.2787	2 440	.2390	5 600	.1812	11 000	.1447		
380	.4443	830	.3424	1 560	.2775	2 460	.2384	5 700	.1801	12 000	.1406		
390	.4405	840	.3411	1 580	.2763	2 480	.2377	5 800	.1791	13 000	.1369		
400	.4367	850	.3397	1 600	.2751	2 500	.2371	5 900	.1781	14 000	.1335		
410	.4332	860	.3384	1 620	.2740	2 550	.2355	6 000	.1771	15 000	.1305		

There is a limit to the speed at which rolling bearings can be operated. Generally it is the operating temperature which can be permitted, with respect to the lubricant being used or to the material of the bearing components, that sets the limit. The speed at which this bearing temperature is reached depends on the frictional heat generated in the bearing (including any externally applied heat) and the amount of heat which can be transported away from the bearing. Bearing type and size, internal design, load, lubrication and cooling conditions as well as cage design, accuracy and internal clearance all play a part in determining the permissible speed.

Speed ratings

Speed ratings for grease and oil lubrication are quoted in the bearing tables. The speed rating for a given bearing represents the speed at which, under normal loading conditions there is a balance between the heat which can be removed from the bearing via the shaft and housing and sometimes via the lubricant and the heat generated in the bearing by friction at acceptable temperature interval above ambient.

The speed ratings apply to bearings where the inner ring rotates. Some reduction may be necessary where bearings are to operate with rotating outer ring. More detailed information will be supplied on request.

When heavier loads are applied to the bearing, the friction in the bearing will be increased so that the bearing cannot be operated at such high speeds as the speed rating would indicate unless higher temperatures can be permitted. However, the influence of heavier loads on the permissible speed is generally only of importance for large bearings ($\geq 100\text{mm}$).

Speeds above the speed rating

It is possible to operate bearings at speeds above the speed ratings given in the bearing tables if the bearing friction can be reduced by lubrication considerations or when heat can be removed from the bearing by circulating oil lubrication with cooling of the oil, by cooling ribs on the housing or by directed cold air streams. Any increase in speed above the speed rating without taking any of these precautions would only cause the temperature to rise excessively. An increase of bearing temperature means that lubricant viscosity is reduced and lubricant film formation is made more difficult, thus leading to higher friction and further temperature increases. If, at the same time, the operational clearance in the bearing is reduced

because of increased inner ring temperature, the final consequence would be bearing seizure. Any increase in speed above the speed rating generally means that the temperature difference between inner and outer ring is greater than normal. Usually, therefore, an internal clearance greater than Normal (C3) is required, and it may be necessary to look more closely at the temperature distribution in the bearing.

The speed limit as defined by the speed rating is the first limit to be reached with almost all bearing types. Above this limit, other criteria have a stronger influence, depending on bearing type. These criteria include the form stability or strength of the cage, lubrication of cage guiding surfaces, centrifugal and gyratory forces acting on the rolling elements and other speed-limiting factors.

Another limit is set with grease lubrication by the grease used. The base oil viscosity and thickener determine the shear strength of the lubricant, which in turn determines the permissible operating speed for the particular bearing.

For high speed bearing arrangements, all components, particularly those which rotate, must have a higher accuracy than normal to take account of the vibrating behaviour. Special cage designs may also be required and it is therefore advisable to contact MRC Bearing Services.

For satisfactory bearing operation, especially at high speeds, a minimum load must be applied. Refer to pages 278 & 279 in the engineering section for methods used to determine minimum loads.

The speed ratings listed in the tables may be modified due to grade and cage variants. The multiplying factors shown in the footnotes are based on historical application and experience.

Satisfactory operation of angular contact ball bearings requires sufficient traction forces between the balls and races to minimize damage caused by sliding or skidding. This is particularly important at high speeds where the inertia forces of the balls and cage and the viscous drag in the lubricant can have a detrimental influence on the rolling conditions.

The minimum required thrust load can be determined from the following formula.

$$F_A = A \left(\frac{n}{1000} \right)^2 \text{ Newtons}$$

OR

$$F_A = 0.2248 A \left(\frac{n}{1000} \right)^2 \text{ Pounds}$$

Where, F_A = Minimum thrust load
 A = Bearing design factor
 listed in the following tables
 n = Speed in RPM

Note: For Duplex Bearings mounted in tandem, multiply the single-bearing thrust value by the number of bearings in tandem.

Minimum Thrust Load A Factor

Size	A	Size	A	Size	A	Size	A	Size	A	Size	A
7100KR	0.06	7120	63.09	7200	0.07	7300	0.11	7200P	0.23	7300P	0.41
7101KR	0.08	7122	94.78	7201	0.11	7301	0.15	7201P	0.29	7301P	0.59
7102KR	0.11	7124	131.20	7202	0.19	7302	0.29	7202P	0.42	7302P	0.85
7103KR	0.20	7126	150.30	7203	0.30	7303	0.63	7203P	0.74	7303P	1.53
7104KR	0.37	7128	200.70	7204	0.42	7304	1.19	7204P	1.32	7304P	1.91
7105KR	0.52	7130	264.00	7205	0.94	7305	1.85	7205P	1.90	7305P	3.85
7106KR	0.95	7132	342.50	7206	1.41	7306	3.45	7206P	3.45	7306P	7.39
7107KR	1.50	7134	435.90	7207	2.82	7307	5.77	7207P	6.73	7307P	11.66
7108KR	1.83	7136	547.00	7208	4.95	7308	9.31	7208P	9.28	7308P	17.31
7109KR	2.88	7138	794.20	7209	5.46	7309	14.26	7209P	13.13	7309P	29.08
7110KR	3.37	7140	977.30	7210	6.87	7310	26.44	7210P	15.48	7310P	36.26
7111KR	6.14	7142	1289.00	7211	13.36	7311	36.89	7211P	23.88	7311P	57.36
7112KR	7.02	7144	1408.00	7212	17.51	7312	50.17	7212P	35.31	7312P	77.30
7113KR	7.97	7146	1686.00	7213	25.86	7313	64.73	7213P	44.55	7313P	111.40
7114KR	11.45	7148	2003.00	7214	27.74	7314	73.28	7214P	53.74	7314P	144.60
7115KR	12.79	7152	2769.00	7215	40.59	7315	110.90	7215P	61.15	7315P	182.70
7116KR	20.43	7156	3679.00	7216	41.61	7316	131.40	7216P	84.07	7316P	215.80
7117KR	22.59	7164	5481.00	7217	61.05	7317	178.20	7217P	112.90	7317P	269.40
7118KR	32.62			7218	95.12	7318	205.60	7218P	148.50	7318P	332.30
7119KR	44.04			7219	108.60	7319	252.80	7219P	191.90	7319P	405.70
7120KR	39.28			7220	141.50	7320	314.00	7220P	224.10	7320P	629.40
7121KR	54.28			7221	169.80	7321	378.20	7221P	282.70	7321P	673.40
7122KR	72.46			7222	212.20	7322	516.40	7222P	352.10	7322P	904.70
7124KR	82.13			7224	271.90	7324	713.30	7224P	450.50	7324P	1227.00
7126KR	147.60			7226	369.40	7326	961.80	7226P	604.70	7326P	1631.00
7128KR	157.90			7228	466.10	7328	1270.00	7228P	761.60	7328P	2128.00
7130KR	211.10			7230	664.90	7330	1628.00	7230P	1074.00	7330P	2731.00
7132KR	276.80			7232	921.10	7332	2089.00	7232P	1314.00	7332P	3198.00
7134KR	410.40			7234	1182.00	7334	2442.00	7234P	1777.00	7334P	3717.00
7136KR	546.70			7236	1316.00	7336	3061.00	7236P	1981.00	7336P	5006.00
7138KR	600.00			7238	1662.00	7338	3791.00	7238P	2499.00	7338P	5739.00
7140KR	831.20			7240	1965.00	7340	4644.00	7240P	3081.00	7340P	7048.00
7144KR	1485.00			7242	2538.00	7342	5634.00				
7148KR	1685.00			7244	3048.00	7344	6774.00				
7152KR	2784.00			7246	3822.00	7348	8517.00				
7156KR	3121.00			7248	4734.00	7352	11310.00				
7160KR	4790.00			7250	5799.00	7356	15430.00				
7164KR	5325.00			7252	7034.00						
				7256	7940.00						
				7260	9950.00						
				7264	12310.00						

Minimum Thrust Load For Angular Contact Ball Bearings

MRC Bearing Services

Satisfactory operation of angular contact ball bearings requires sufficient traction forces between the balls and races to minimize damage caused by sliding or skidding. This is particularly important at high speeds where the inertia forces of the balls and cage and the viscous drag in the lubricant can have a detrimental influence on the rolling conditions.

The minimum required thrust load can be determined from the following formula.

$$F_A = A \left(\frac{n}{1000} \right)^2 \text{ Newtons}$$

OR

$$F_A = 0.2248 A \left(\frac{n}{1000} \right)^2 \text{ Pounds}$$

Where, F_A = Minimum thrust load
 A = Bearing design factor
 listed in the following tables
 n = Speed in RPM

Note: For Duplex Bearings mounted in tandem, multiply the single-bearing thrust value by the number of bearings in tandem.

Minimum Thrust Load A Factor

Size	A	Size	A	Size	A	Size	A	Size	A
7405P	10.80	7205PJ	1.71	9100UK	0.06	9202U	0.19	9202UP	0.42
7406P	16.17	7206PJ	4.07	9101UK	0.08	9203U	0.30	9203UP	0.74
7407P	27.54	7207PJ	7.29	9102UK	0.11	9204U	0.42	9204UP	1.32
7408P	38.49	7208PJ	10.92	9103UK	0.20	9205U	0.94	9205UP	1.90
7409P	58.46	7209PJ	12.80	9104UK	0.37	9206U	1.41	9206UP	3.45
7410P	78.46	7210PJ	15.04	9105UK	0.52	9207U	2.82	9207UP	6.73
7411P	111.70	7211PJ	23.48	9106UK	0.95	9208U	4.95	9208UP	9.28
7412P	143.60	7212PJ	34.61	9107UK	1.50	9209U	5.46	9209UP	13.13
7413P	181.90	7213PJ	47.73	9108UK	1.83	9210U	6.87	9210UP	15.48
7414P	309.20	7214PJ	56.67	9109UK	2.88	9211U	13.36	9211UP	23.88
7415P	376.40	7215PJ	63.52	9110UK	3.37	9212U	17.51	9212UP	35.31
7416P	452.40	7216PJ	84.96	9111UK	6.14	9213U	25.86	9213UP	44.55
7417P	542.30	7217PJ	113.70	9112UK	7.02	9214U	27.74	9214UP	53.74
7418P	724.60	7218PJ	148.60	9113UK	7.97	9215U	40.59	9215UP	61.15
7419P	1083.00			9114UK	11.45	9216U	41.61	9216UP	84.07
7420P	1387.00	7304PJ	2.07	9115UK	12.79	9217U	61.05	9217UP	112.90
7421P	1546.00	7305PJ	4.30	9116UK	20.43	9218U	95.12	9218UP	148.50
		7306PJ	8.13	9117UK	22.59	9219U	108.60	9219UP	191.90
8218	148.50	7307PJ	11.10	9118UK	32.62	9220U	141.50	9220UP	224.10
8219	191.90	7308PJ	18.88	9119UK	44.04	9221U	169.80	9221UP	282.70
8220	224.10	7309PJ	29.19	9120UK	39.28	9222U	212.20	9222UP	352.10
8222	352.10	7310PJ	45.54	9121UK	54.28				
8224	450.50	7311PJ	62.57	9122UK	72.46	9302U	0.29	9302UP	0.85
8238	2499.00	7312PJ	84.44			9303U	0.63	9303UP	1.53
8308	17.31	7313PJ	111.50			9304U	1.19	9304UP	1.91
8309	29.08	7314PJ	144.60			9305U	1.85	9305UP	3.85
8310	36.26	7315PJ	184.90			9306U	3.45	9306UP	7.39
8311	57.36	7316PJ	233.80			9307U	5.77	9307UP	11.66
8312	77.30	7317PJ	291.90			9308U	9.31	9308UP	17.31
8313	114.40	7318PJ	360.00			9309U	14.26	9309UP	29.08
8314	144.60	7319PJ	439.50			9310U	26.44	9310UP	36.26
8315	182.70					9311U	36.89	9311UP	57.36
8316	215.80					9312U	50.17	9312UP	77.30
8317	269.40					9313U	64.73	9313UP	111.40
8318	332.30					9314U	73.28	9314UP	144.60
8319	405.70					9315U	110.90	9315UP	182.70
8320	629.40					9316U	131.40	9316UP	215.80
8322	904.70					9317U	178.20	9317UP	269.40
8326	1631.00					9318U	205.60	9318UP	332.30
8330	2731.00					9319U	252.80	9319UP	405.70
8336	5006.00					9320U	314.00	9320UP	629.40
						9321U	378.20	9321UP	673.40
						9322U	516.40	9322UP	904.70

To insure satisfactory operation of double row, angular contact ball bearings, they must be subjected to a minimum radial load, which is especially true at high speeds where inertia forces of the balls and cage, and the friction in the lubricant, can cause skidding to occur between the balls and raceway.

The required minimum radial load can be estimated from:

$$F_{r,m} = K_r \left(\frac{v n}{1000} \right)^{2/3} \left(\frac{d_m}{100} \right)^2$$

$F_{r,m}$ = Minimum radial load (N)

K_r = Minimum load factor

Series	Kr
5200SB&C	60
5200M	90
5300SB&C	70
5300M	110
5400C	70

v = Oil viscosity at operating temperature (cSt)

n = Speed in RPM

d_m = Mean bearing diameter = $\left(\frac{D + d}{2} \right)$, (mm)

D = Bearing outside diameter (mm)

d = Bearing inside diameter (mm)

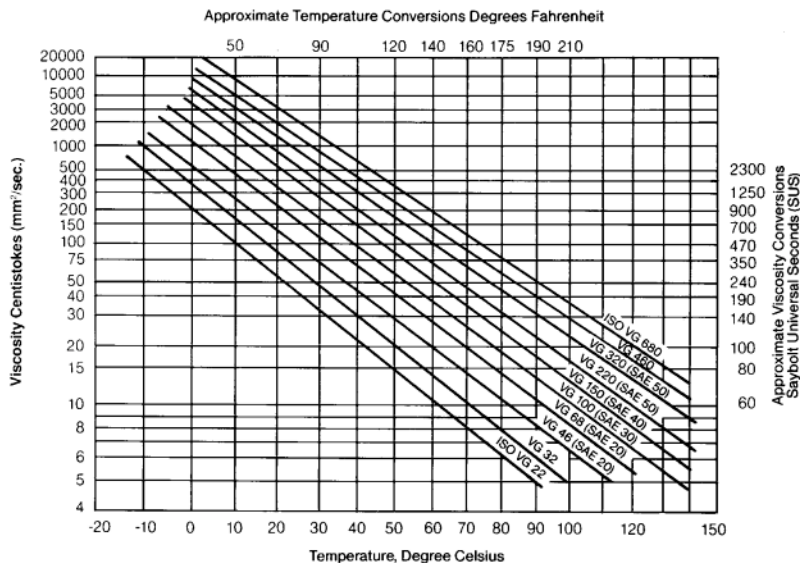
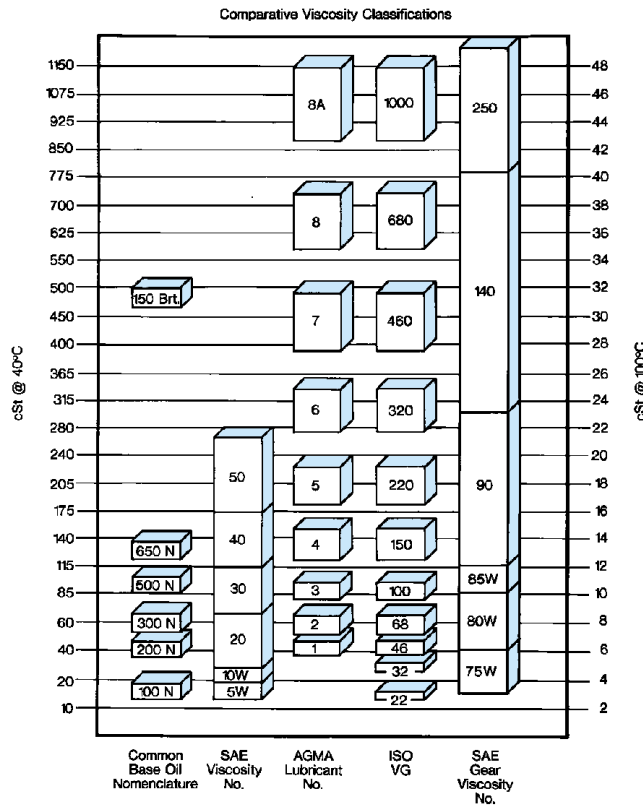

NOTE: Viscosity classification numbers are according to International Standard ISO 3448-1975 for oils having a viscosity index of 95. Approximate equivalent SAE viscosity grades are shown in parentheses.

NOTES

Materials for Rolling Bearings

The performance and reliability of rolling bearings are determined to a large degree by the materials from which the bearing components are made.

Steels for Bearing Rings and Rolling Elements

Steels used for bearing rings and rolling elements must be capable of high fatigue strength and wear resistance. The structural and dimensional stability of the bearing components must be satisfactory at the operating temperatures which can be expected. In most cases the choice of a particular steel is dictated by the application requirements.

Through-Hardening Steels

The most common through-hardening steel used for rolling bearings is a carbon chromium steel containing approximately 1% carbon and 1.5% chromium. For bearing components having large cross sections steels alloyed with manganese and molybdenum are used because of their superior through-hardening properties.

Much development has been accomplished in the area of through hardened steels. Particular attention has been paid to cleanliness and modern bearing steels have such small contents of inclusions that it is now recognized that under ideal conditions bearings should no longer fail from fatigue.

Case-Hardening Steels

Chromium-nickel and manganese-chromium alloyed steels with a carbon content of approximately 0.15% are those case-hardening steels most commonly used for rolling bearings.

Steels for MRC Rolling Bearings

In the majority of applications there is virtually no difference in behavior between bearings made of through-hardened or case-hardened steels. This fact has been acknowledged by ISO in that no distinction is made between steel types in the life calculation. In fact, steel cleanliness and proper manufacturing methods as well as bearing design are the decisive factors. However, there are applications where a particular type of steel has certain advantages.

Because MRC has both the competence and the facilities for through hardening, case hardening and induction hardening, attention is paid to the main application fields for each particular bearing and the steel and method of heat treatment are chosen to give the best performance in these applications.

Steels for Temperature-Resistant Bearings

MRC rolling bearings can generally be used at operating temperatures up to 250°F (121°C). If the operating temperatures are higher than this, the

bearings must be subjected to a special heat treatment (stabilization) so that inadmissible changes in dimensions do not occur as a result of microstructural changes. However, the bearings should not be stabilized for a higher temperature than the expected operating temperature.

For bearings which are required to operate at temperatures in excess of 450°F (232°C) special steels with high hot hardness are required. In such cases it is advisable to contact MRC Bearing Services Engineering.

Steels for Corrosion-Resistant Bearings

For bearings which come into contact with corrosive media during operation chromium or chromium/molybdenum stainless steels are used. Because of the reduced hardness of these steels, the bearings do not have the same high load carrying capacity as bearings made of conventional steels. The corrosion resistance is only available when the whole surface is perfectly polished and if it is not roughened or damaged during mounting. It is recommended to seek advice from MRC regarding the selection and application of stainless steel bearings.

Hybrid Bearings with Ceramic Balls

MRC hybrid bearings use steel inner and outer rings with ceramic balls. This combination provides a bearing that has greater stiffness, is able to handle higher speeds and higher temperatures.

The lower density of the silicon nitride ceramic balls creates less centrifugal force than steel balls. Lower density combined with the reduced friction due to the ball's smooth surface, allows the bearing to run at much higher speeds. The low thermal expansion of the ceramic balls makes them less sensitive to differences in temperature between the inner and outer rings. The higher modulus of elasticity makes the bearings much stiffer.

Materials for Cages

The main purpose of the cage is to keep the rolling elements at an appropriate distance from each other and to prevent immediate contact between two neighboring rolling elements in order to keep friction and thus heat generation in the bearing at a minimum.

In grease lubricated bearings some of the grease inside the bearing will adhere to the cage forming a lubricant reservoir and ensuring good lubrication of the operating surfaces of the bearing.

The cage is guided either on the rolling elements or on one of the bearing rings and is thus radially centered. Pressed steel or brass cages are generally guided on the rolling elements. Inner or outer ring land guided machined cages generally permit operation at higher speeds and are necessary when movements additional

to the pure rotational are superimposed, particularly when conditions of high acceleration prevail. Suitable steps must be taken (e.g. oil lubrication) to ensure that there is a sufficient supply of lubricant to the guiding surfaces of the cage and to the inside of the bearing.

Rolling bearing cages are mechanically stressed by frictional, strain and inertia forces. They may also be subjected to the chemical action of certain lubricants, lubricant additives or products of their aging, organic solvents, coolants (halogenated hydrocarbons, ammonia) etc. Thus the design and choice of material are of paramount importance for the performance of the cage as well as for the operational reliability of the bearing as a whole.

Standard Cages

As rolling bearings have been developed various cage types and designs for the different bearing types and sizes have emerged; the cages differ as to form, material, manufacturing methods, cost of production and operational limits.

In the text preceding each section, information is provided regarding the standard cages with which the bearings are fitted and also the possible alternatives. The standard cage is always well proven in service and is the design considered most suitable for the majority of applications. With reference to the viability of production, the costs and the different application areas of the bearings, the standard cage for the larger bearings may be different from that for the smaller bearings in one and the same series. If a bearing with a non-standard cage is required it is always advisable to check availability before ordering.

Molded Polyamide Cages

For some bearing types, e.g. double row deep groove ball bearings, and angular contact ball bearings, the small and medium-sized bearings are available with molded cages of heat stabilized, glass fiber reinforced polyamide 6,6. Heat stabilized, unfilled polyamide cages are available for a limited number of sizes. This material is characterized by a favorable combination of strength and elasticity. The good sliding properties of polyamide on lubricated steel surfaces and the smoothness of the cage surfaces in contact with the rolling elements mean that little friction is generated by the cage so that heat generation and wear in the bearing are at a minimum. The low density of the material means that the inertia of the cage is small. All these factors plus inherently superior dynamic balance result in smoother and quieter running bearings.

The injection molding process used to produce the cages allows functionally suitable designs to be made. The excellent running properties of polyamide cages

under lubricant starvation conditions permit continued operation of the bearing for a time reducing the risk of seizure and secondary damage.

When using bearings with polyamide cages the permissible operating temperatures for the material and its resistance to the lubricant used must be observed. At operating temperatures up to the values given in the adjacent table for the various oils and greases which are used as bearing lubricants, cage properties are unaffected. If the permissible temperature is exceeded, the cage material will age, this process being accelerated the longer the cage is exposed to the excessive temperature. Brief periods at up to 70°F (21°C) above the recommended maximum temperatures can be tolerated provided they are interspersed with longer periods at operating temperatures below the recommended values, and provided the maximum operating temperature for the lubricant is not exceeded. When operating temperatures are constantly above 250°F (121°C) bearings fitted with metallic cages are recommended. Molded polyamide cages are also unsuitable for operating temperatures below -40°F (-40°C) as they lose their elasticity.

The organic solvents normally used to clean rolling bearings such as white mineral spirits or trichloroethane do not affect cage properties, nor do dilute alkaline cleaners (e.g. soda) if they are at room temperature and the period during which they are in contact is short. The chlorofluorocarbons or ammonia used in refrigeration do not attack polyamide. In vacuum, polyamide cages become brittle because they become dehydrated.

Permissible operating temperatures for cages of glass fibre reinforced polyamide 6,6 with various bearing lubricants		
Lubricant	Permissible operating temperature ¹⁾	
	°C	°F
Mineral oils		
Oils without EP additives e.g. machine oils, hydraulic oils	120	248
EP oils e.g. industrial and automotive gearbox oils	110	230
EP oils e.g. rear axle and differential gear oils (automotive), hypoid gear oils	100	212
Synthetic oils		
Polyglycols, poly- α -olefins	120	248
Diesters, silicones	110	230
Phosphate esters	80	176
Greases		
Lithium base, ²⁾ polyurea, bentonite, calcium complex	120	248

¹⁾Measured on the outside surface of the outer ring.
²⁾For sodium and calcium base greases and other bearing greases with a maximum operating temperature below 120°C, the maximum temperature for the polyamide cage is the same as the maximum temperature for the grease, otherwise the permissible operating temperature is 120°C.

Steel Cages

Pressed cages of steel sheet are standard for many deep groove ball bearings. These cages have relatively

high strength and weigh little. To reduce friction and wear they may be hardened and surface treated. High strength, machined steel cages, often silver plated are also available for critical and extra heavy duty applications.

Machined Bronze

Machined bronze cages are used for heavy duty applications and larger size bearings. Machined bronze cages can be used at operating temperatures up to 450°F (232°C). They are not affected by the mineral or synthetic oil based lubricants normally used for rolling bearings nor by the organic solvents used to clean bearings. They are very resistant to corrosive attack.

Brass Cages

Pressed brass cages are used for some small and medium-sized bearings, but most brass cages are

machined from cast or wrought material. Brass cages should not be used at temperatures in excess of 450°F (232°C). They are unaffected by most of the commonly used bearing lubricants, including synthetic oils and greases, and can be cleaned using normal organic solvents. The use of alkaline cleaning agents is not recommended. Ammonia (e.g. in refrigeration) causes embrittlement in brass so that brass cages are unsuitable and other alternatives should be considered.

Phenolic (Bakelite) Cages

Phenolic cages are used primarily for angular contact ball bearings. These cages are composed of machined, cotton fabric impregnated with phenolic resin. The light weight construction of the phenolic cage makes it ideal for high speed applications. Phenolic cages should not be used in temperatures in excess of 225°F (107°C).

Bearing Component	Material	Description	Dynamic Operating Temperature Limits
Race Way Rings and Balls	SAE 52100 (AISI E-52100)	Vacuum processed high carbon chromium steel. Special heat treatment increases maximum temperatures and improves dimensional stability. ¹⁾	250 °F (121 °C) Max. Special Heat Treatment up to 400 °F (204 °C) Max. ¹⁾
	440C martensitic stainless steel ¹⁾	Moderate corrosive environments	300 °F (148 °C) Max. Special Heat Treatment up to 800 °F (426 °C) Max. ¹⁾
	M50 tool steel ¹⁾	High temperature service, improved life at elevated temperatures	600 °F (315 °C) Max.
Seals	Nitrile Rubber	Standard MRC seal material, identified by black color	-70 °F to 250 °F -56 °C to 121 °C
	Fluorocarbon seals (Viton®) ¹⁾	Better temperature and chemical resistance, identified by grey or brown color	-40 °F to 400 °F -40 °C to 204 °C
	PTFE Seals (Teflon®) ¹⁾	Superior chemical and heat resistance, identified by tan color and "woven" appearance	-450 °F to 550 °F -267 °C to 288 °C
Shields	1010 Low Carbon Steel	Standard MRC shield material	450 °F (232 °C) Max.
	302 Stainless Pressed Steel ¹⁾	Corrosive environments	450 °F (232 °C) Max.
Ball Cages ²⁾ (Separator)	1010 Pressed Steel	Standard MRC pressed cage material	450 °F (232 °C) Max.
	Machined Phenolic (Bakelite)	Composition made from a cotton fabric impregnated with phenolic resin; two piece riveted or one piece machined design	225 °F (110 °C) Max.
	Molded Polyamide	Heat stabilized 6/6 polyamide. Identifiable by natural (cream color); ball guided design	250 °F (121 °C) Max.
	Molded Reinforced Polyamide	Heat stabilized 6/6 polyamide reinforced with glass fiber; ball guided design identifiable by dark grey color	250 °F (121 °C) Max.
	302 Pressed Stainless Steel	Corrosive environments; ball guided two piece riveted design	450 °F (232 °C) Max.
	Pressed Brass	Stamped one piece ball guided or two piece ball guided riveted design	450 °F (232 °C) Max.
	4340 Machined Steel	One piece land or ball guided design	575 °F (302 °C) Max.
Machined Bronze	One piece land or ball guided design	450 °F (232 °C) Max.	

¹⁾ Contact MRC for availability

²⁾ Contact MRC for ball cages available for specific sizes.

Teflon is a registered trademark of E. I. duPont de Nemours & Co.

Viton is a registered trademark of E. I. duPont de Nemours & Co.

Table of Contents

	Page
Introduction	286
Bearing Construction	286
Principle Of Operation	286
Friction Torque	287
Function Of The Lubricant	287
Oil vs Grease	287
Oil Characteristics	287
Application Of Lubrication Fluids	288
Selection Of Oil	289
Comparative Viscosity Classifications	291
Viscosity Conversion Chart	291
Oil Flow Requirement	290
Grease Lubrication	290
Grease Characteristics	292
Operating Conditions	293
Relubrication Intervals	295
Bearing Cleaning	296
Things You Should Know About Lubrication	297
Lubrication Methods	298

Lubrication of Anti-Friction Bearings

Introduction

Although the basic principle of ball and roller bearings is the rolling of one element over another, some sliding friction is generated during operation of anti-friction bearings. Successful operation of an anti-friction bearing requires a lubricating film in the areas of sliding contact. In cageless bearings, the rolling elements slide against each other. When a cage is present the rolling elements slide against this and under some operating conditions, the cage slides against ring guiding surfaces. When a ball under load rolls in a curved bearing raceway, pure rolling occurs only along two lines in the contact area; other contact points on the ball slide or spin along areas of the raceway. This is because the effective diameter of the ball is smaller at points distant from the bottom of the race-groove. See Figure 1.

- a. The forces of slippage between zone #1 and the two zones #2 are equal in magnitude.
- b. The slippage in zone #1 is in opposite direction from that in zone #2.
- c. Technically the zones of pure rolling in #3 are very narrow but there are larger areas that approach pure rolling.
- d. These conditions exist, although less obvious, even when loads are lighter and the ball paths narrower.

Without lubrication in the highly loaded contact areas, very high friction will be encountered in ball bearings. High friction generally creates high heat and thermal expansion, usually concentrated in the rolling elements and inner ring races which may cause a loss of internal clearance and radial preloading. This frequently causes surface degeneration and early fatigue. Cage breakage may also result from extreme stresses.

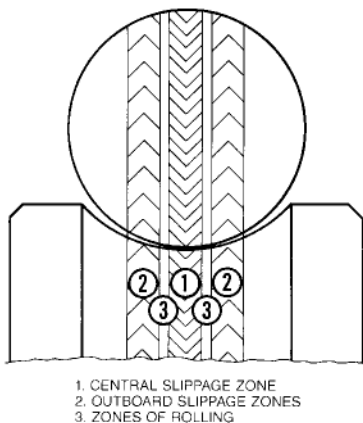

Figure 1

Bearing Construction

An anti-friction bearing is a precision device and a marvel of engineering. It is unlikely that any other mass produced item is machined to such close tolerances. While boundary dimensions are usually held to tenths of a thousandth of an inch, rolling contact surfaces and geometries are maintained to millionths of an inch. It is for this obvious reason that very little surface degradation can be tolerated.

Bearing steels are hard, durable alloys, highly free of impurities in order to withstand the high unit stresses which occur at the point of contact between a rolling element and the race. Also, they must be sufficiently elastic to quickly regain their original shape after deformation through loading.

Race and rolling element finish are also critical since even minute surface imperfections can cause high stress concentrations resulting in premature failure.

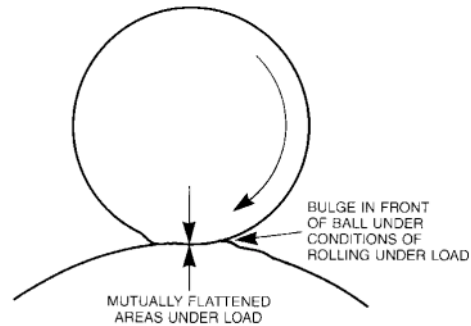

Figure 2

Principle of Operation

When a ball in a bearing is subjected to load, an elliptical area of contact results between the ball and the race. In operation, as each ball enters the loaded area, slight deformation of both the ball and the race occurs. The ball flattens out in the lower front quadrant and bulges in the lower rear quadrant. (See Figure 2) The amount of deformation is a function of the magnitude and direction of load, ball size, race geometry, and elasticity of the bearing materials. Any particular point on the race goes through a cycle of these stress reversals as each ball passes it. One source of heat developed in a bearing results from these stresses and the deformation of the bearing material associated with them.

The life of an anti-friction bearing running under good operating conditions is usually limited by fatigue failure rather than by wear. Under optimum operating conditions, the fatigue life of a bearing is determined by the number of stress reversals and by the cube of the load causing these stresses. As examples, if the load on the bearing is doubled, the theoretical fatigue life is reduced to one-eighth. Also, if speed is doubled, the theoretical fatigue life is reduced to one-half.

Friction Torque

The friction torque in an anti-friction bearing consists essentially of two components. One of these is a function of the bearing design and the load imposed on the bearing. The other is a function of the lubricant type, the quantity, and the speed of the bearing.

It has been found that the friction torque in a bearing is lowest with a quantity of the correct viscosity oil just sufficient to form a film over the contacting surfaces. The friction will increase with greater quantity and/or high viscosity of the oil. With more oil than just enough to make a film, the friction torque will also increase with the speed.

Function of The Lubricant

1. To lubricate sliding contact between the cage and other parts of the bearing.
2. To provide a film of oil between rolling contact surfaces (elastohydrodynamic lubrication).
3. To lubricate the sliding contact between the rolls and guiding elements in roller bearings.
4. In some cases, to carry away the heat developed in the bearing.
5. To protect the highly finished surfaces from corrosion.
6. To provide a sealing barrier against foreign matter.

Oil Versus Grease

The ideal lubricant for rolling element bearings is oil. Grease, formed by combining oil with soap or non-soap thickeners, is simply a means of effecting greater utilization of the oil. In a grease, the thickener acts fundamentally as a carrier and not as a lubricant.

Greases are now used for lubricating by far the larger number of rolling bearings. The extensive use of grease has been dictated by the possibilities of simpler housing designs, less maintenance, less difficulty with leakage, and better sealing against dirt. On the other hand, there are limitations which do not permit the use of grease. Where a lubricant must dissipate heat rapidly, grease should not be used. In many cases, associated machine elements that are oil lubricated dictate the use of oil for anti-friction bearings. Listed below are some of the advantages and disadvantages of grease lubrication.

Advantages

1. Simpler housing designs are possible; piping is greatly reduced or eliminated.
2. Maintenance is greatly reduced since oil levels do not have to be maintained.

3. Being a solid when not under shear, grease forms an effective collar at bearing edges to help seal against dirt and water.
4. With grease lubrication, leakage is minimized where contamination of products must be avoided.
5. During start-up periods, the bearing is instantly lubricated whereas with pressure or splash oil systems, there can be a time interval during which the bearing may operate before oil flow reaches the bearing.

Disadvantages

1. Extreme loads at low speed or moderate loads at high speed may create sufficient heat in the bearing to make grease lubrication unsatisfactory.
2. Oil may flush debris out of the bearing. Grease will not.
3. The correct amount of lubricant is not easily controlled as with oil.

Oil Characteristics

The ability of any oil to meet the requirements of specific operating conditions depends upon certain physical and chemical properties.

Viscosity

The single most important property of oil is viscosity. It is the relative resistance to flow. A high viscosity oil will flow less readily than a thinner, low viscosity oil.

Lubrication Viscosity

There are a number of instruments used for determining the viscosity of oil. In the United States the instruments that are usually used are the Viscosimeter or the Viscometer. The Saybolt Universal Viscosimeter measures the time in seconds required for 60cc of oil to drain through a standard hole at some fixed temperature. When this unit is used the viscosities are quoted in terms of Saybolt Universal Seconds (SUS).

When the Kinematic Viscometer is used to measure oil viscosity, the time required for a fixed amount of oil to flow through a calibrated capillary is used as an intermediate value for calculating viscosity. The unit of kinematic viscosity is the stoke or the centistoke (cSt). The common temperatures for reporting viscosity are 104°F and 212°F (40°C and 100°C).

Generally, for ball bearings and cylindrical roller bearings, it is a good rule to select an oil which will have a viscosity of at least 70 SUS (15 cSt) at operating temperature.

Viscosity Index

All oils are more viscous when cold and become thinner when heated. However, some oils resist this change of viscosity more than others. Such oils are said to have a high viscosity index (V.I.). Viscosity index is most important in an oil where it must be used over a wide range of temperatures. Such an oil should resist excessive changes in viscosity. A high V.I. is usually associated with good oxidation stability and can be used as a rough indication of such quality.

Pour Point

Any oil, when cooled, eventually reaches a temperature below which it will no longer flow. This temperature is said to be the pour point of the oil. At temperatures below its pour point an oil will not feed into the bearing and lubricant starvation may result.

In selecting an oil for anti-friction bearings, the pour point must be considered in relation to the operating temperature.

Flash and Fire Point

As an oil is heated, the lighter fractions tend to volatilize. With any oil, there is some temperature at which enough vapor is liberated to flash into momentary flame when ignition is applied. This temperature is called the flash point of the oil. At a somewhat higher temperature enough vapors are liberated to support continuous combustion. This is called the fire point of the oil. The flash and fire points are significant indications of the tendency of an oil to volatilize at high operating temperatures. High V.I. base oils generally have higher flash and fire points than lower V.I. base oils of the same viscosity.

Oxidation Resistance

All petroleum oils are subject to oxidation by chemical reaction with oxygen of air. This reaction results in the formation of acids, gum, sludge, and varnish residues which can reduce bearing clearances, plug oil lines and cause corrosion.

Some lubricating fluids are more resistant to this action than others. Oxidation resistance depends upon the fluid type, the methods and degree of refining used, and whether oxidation inhibitors are used.

There are many factors which contribute to the oxidation of oils and practically all of these are present in lubricating systems. These include temperature, agitation, and the effects of metals and various contaminants which increase the rate of oxidation.

Temperature is a primary accelerator of oxidation. It is well known that rates of chemical reaction double for every 18°F (10°C) increase in temperature. Below 140°F (60°C), the rate of oxidation of oil is rather slow.

Above this temperature, however, the rate of oxidation increases to such an extent that it becomes an important factor in the life of the oil. It is for this reason that it is desirable that oil systems operate at as low an over-all temperature as is practical.

The oxidation rate of oil is accelerated by metals such as copper and copper-containing alloys and to a much lesser extent by steel. Contaminants such as water and dust also act as catalysts to promote oxidation of the oil.

Emulsification

Generally, water and straight oils do not mix. However, when an oil becomes dirty, the contaminating particles act as agents to promote emulsification. In anti-friction bearing lubricating systems, emulsification is undesirable and the oil should separate readily from any water present. The oil should have good demulsibility characteristics.

Rust Prevention

Although straight petroleum oils have some rust protective properties, they can not be depended upon to do an unfailing job of protecting rust-susceptible metallic surfaces. In many instances, water can displace the oil from the surfaces and cause rusting. Rust is particularly undesirable in an anti-friction bearing because it can seriously abrade the bearing elements and areas that are pitted by rust will cause rough operation or failure of the bearing.

Additives

High grade lubricating fluids are formulated to contain small amounts of special chemical materials called additives. Additives are used to increase the viscosity index, fortify oxidation resistance, improve rust protection, provide detergent properties, increase film strength, provide extreme pressure properties, or lower the pour point.

Application of Lubrication Fluids

The amount of oil needed to maintain a satisfactory lubricant film in an anti-friction bearing is extremely small. The minimum quantity required is a film averaging only a few microinches in thickness. Once this small amount has been supplied, make-up is required only to replace that lost by vaporization, atomization, and creepage from the bearing surfaces. Some idea of the small quantity of oil required can be realized when it is known that 1/1000 of a drop of oil, having a viscosity of 300 SUS at 100°F (38°C) per hour can lubricate a 50 mm bore bearing running at 3,600 RPM. Although this small amount of oil can adequately lubricate a bearing, much more oil is needed to dissipate heat generated in high speed, heavily loaded bearings.

Oil may be supplied to anti-friction bearings in a number of ways. These include bath oiling, oil mist from an external supply, wick feed, drip feed, circulating system, oil jet, and splash or spray from a slinger or nearby machine parts.

One of the simplest methods of oil lubrication is to provide a bath of oil through which the rolling element will pass during a portion of each revolution. Where cooling is required in high speed and heavily loaded bearings, oil jets and circulating systems should be considered. If necessary, the oil can be passed through a heat exchanger before returning to the bearing.

Selection of Oil

The most important property of lubricating oil is the viscosity. Figures 1 and 2 should be used to assure that the viscosity is adequate in an application. Figure 1 yields the minimum required viscosity as a function of bearing size and rotational speed.

The viscosity of a lubricating oil, however, varies with temperature. It decreases with increasing temperature. Therefore, the viscosity at the operating temperature must be used, rather than the viscosity grade (VG) which is based on the viscosity at the internationally standardized reference temperature of 40°C (104°F). Figure 2 can be used to determine the actual viscosity at the operating temperature, which, however, varies with bearing design. For instance tapered and spherical

roller bearings usually have a higher operating temperature than ball bearings or cylindrical roller bearings under comparable operating conditions.

Example:

A bearing having a bore diameter of 45 mm and an outside diameter of 85 mm is required to operate at a speed of 2000 rpm. The pitch diameter $d_m = 0.5(d + D) = 0.5(45 + 85) = 65$ mm. As shown in Figure 1, the intersection of $d_m = 65$ mm with the oblique line representing 2000 rpm yields a minimum viscosity required of 13 mm²/s. Now let us assume that the operating temperature is 80°C (176°F). In Figure 2, the intersection between temperature 80°C and required viscosity 13 mm²/s is between the oblique lines for VG46 and VG68. Therefore, a lubricant with the viscosity grade of at least VG46 should be used, i.e. a lubricant of at least 46 mm²/s viscosity at the standard reference temperature of 40°C.

When determining the operating temperature, it should be kept in mind that the temperature of the oil is usually 3° to 11°C (5° to 20°F) higher than that of the bearing housing. For example, assuming that the temperature of the bearing housing is 77°C (170°F), the temperature of the oil will usually be 80° to 88°C (176° to 190°F).

If a lubricant with higher than required viscosity is selected, an improvement in bearing performance (life) can be expected.

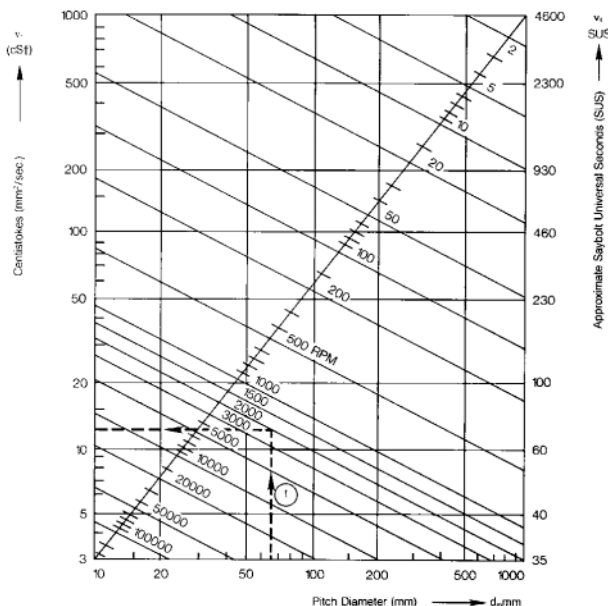

Figure 1
Minimum Required Lubricant Viscosity

$d_m = (\text{bearing bore} + \text{bearing O.D.})/2$
 $v_1 =$ required lubricant viscosity for adequate lubrication at the operating temperature

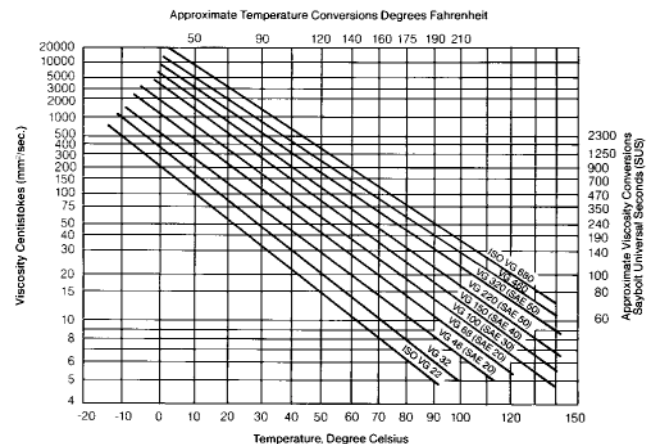

Figure 2 Viscosity-Temperature Chart

NOTE: Viscosity classification numbers are according to International Standard ISO 3448-1975 for oils having a viscosity index of 95. Approximate equivalent SAE viscosity grades are shown in parentheses.

However, since increased viscosity raises the bearing operating temperature, there is frequently a practical limit to the lubrication improvement which can be obtained by this means. Also only solvent refined mineral oil should be used.

For exceptionally low or high speeds, for critical loading conditions or for unusual lubrication conditions, please consult MRC Applications Engineering.

For all calculations, the viscosity should be expressed in mm² /s (cSt) rather than in Saybolt Universal Seconds (SUS), as the conversion between these two viscosity units is nonlinear. However, the SUS scale shown on the right of Figures 1 and 2 can be used for approximate conversion of SUS to mm² 2 /s (cSt).

For comparative viscosity classifications and conversion tables see next page.

Oil Flow Requirement

For high speed and/or high temperature applications, a major function of the lubricant is to remove heat, and circulating oil lubrication is necessary.

Unfortunately, excessive quantity of lubricant within the bearing boundary dimensions, i.e., within the *free volume*, causes increased friction and hence increased heat generation owing to *fluid churning*. Therefore the lubricant flow rate through the bearing should be as little as possible, consistent with good lubricant film formation and heat removal. This minimum acceptable flow rate can be achieved using *air-oil mist* lubrication. Care must be exercised to assure that the lubricant flow rate is sufficient to avoid *lubricant starvation* in high speed applications. In this condition, insufficient lubricant enters the rolling element-raceway contacts to permit formation of lubricant films thick enough to separate the components.

From a heat removal standpoint and as a starting point to determine the required lubricant flow rate in gallons per minute (*W*), the following approximate formula may be used:

In English system units, the flow rate in gallons per minute (*W*) is:

$$W = \frac{1.9 \times 10^{-4} \mu P d_m n}{(T_o - T_i)}$$

in which μ is the bearing coefficient of friction, P is imposed load in pounds, d_m is bearing pitch diameter in inches, n is bearing net speed (*shaft speed minus outer ring speed*) in rpm, T_o is lubricant outlet temperature in °F and T_i is lubricant inlet temperature in °F. The table below gives appropriate values of μ .

Coefficient of Friction (μ)

Radial ball bearings	0.0015
Angular-contact ball bearings	0.0020
Split inner ring ball bearings	0.0024
Cylindrical roller bearings	0.0011

Lubricating Grease

Most greases are composed of a soap thickening agent in petroleum oil. Soap is formed by combining a metallic alkali such as the hydroxide of sodium or lithium with a fatty material. The type and quality of soap determines the grease consistency, texture, melting point, and solubility in water. Sometimes a mixture of soaps is used to alter the properties. Additives are used to impart such properties as increase in load carrying capacity, rust prevention, and oxidation stability.

Lithium soap petroleum greases are widely used because of their good water resistance, relatively good high and low temperature characteristics, and good mechanical stability. Sodium soap greases are not water resistant and are readily washed away by large amounts of water. However, they have excellent rust preventive properties due to their ability to absorb minor amounts of water contamination.

Greases containing thickeners other than metallic soaps are being used increasingly because they offer greater resistance to heat. They are a multi-purpose type and have good water resistance. Surface treated clay is an inorganic thickener used in many greases.

Intensive research in the development of oxidation resistant formulations has resulted in great increases in the life which lubricating greases can provide. Through the use of synthetic oily compounds and non-soap thickeners, grease lubrication can now be achieved over a temperature range of -100°F to + 500°F (-73°C to 260°C) and higher in some cases.

Synthetic greases are formulated with synthetic fluids such as silicones, esters, perfluoroalkyl ethers, or polyphenyl ethers instead of petroleum oil. The thickener may be soap or non-soap. Synthetic greases are used in extremely high or low temperature applications that are outside the range for petroleum greases. They are relatively expensive and therefore are not usually recommended if petroleum greases will serve the purpose.

In the great majority of applications where the operating conditions are normal, many different greases can be used satisfactorily. However, each grease has certain limitations and properties. In applications where elevated temperature, high speed, heavy loading, high humidity, or other extreme conditions are encountered, consideration must be given to the choice of a grease. In some instances it will be found that no available grease has all the properties to satisfy the requirements and the choice must be a compromise.

It is recommended that the bearing user consult with MRC Technical Services Department to determine the lubricant which will be most suitable for the application.

Comparative Viscosity Classifications

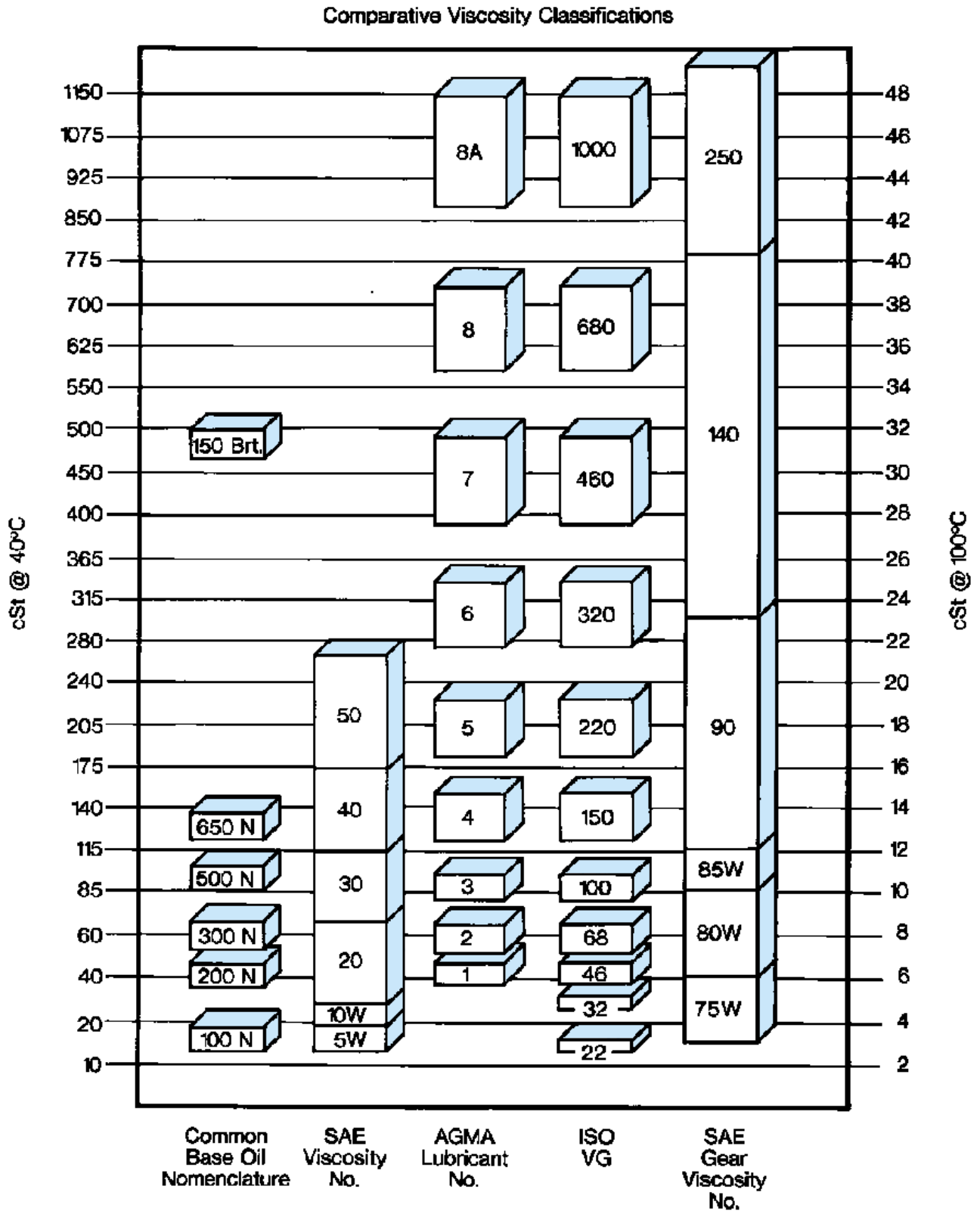

Grease Characteristics

Consistency

Greases vary in consistency from semi-fluids to hard, brick type greases which are cut with a knife. The method for measuring grease consistency (ASTM D-217), established by the American Society for Testing and Materials, uses a penetrometer with which a cone of standard shape and weight is dropped into the grease and the depth of penetration in five seconds at 77°F (25°C) is measured in tenths of a mm. The penetration is usually measured on both unworked grease as it comes from its shipping container and also after it has been worked 60 strokes by a perforated disc plunger.

Usually greases become softer when subjected to mechanical working action. These consistency measurements are expressed as unworked and worked. The 60 stroke working is done to minimize the effects of any previous manipulation of the grease in sampling. Also, the worked penetration indicates the relative softening after a limited amount of shear. However, this working cannot be correlated to the much more severe shearing action that occurs in a bearing.

Listed in the table below is a classification of the consistency of grease in terms of worked penetration as developed by the National Lubricating Grease Institute.

NLGI No.	Worked Penetration
000	445 – 475
00	400 – 430
0	355 – 385
1	310 – 340
2	265 – 295
3	220 – 250
4	175 – 205
5	130 – 160
6	85 – 115

Most rolling bearing greases fall into classes 1-4. By far the greater portion of bearing applications use NLGI Grade 2 grease.

Dropping Point

When a grease is heated, it softens. The temperature at which a drop falls from a sample in a standard test (ASTM D-566) is called its dropping point. The dropping point cannot be used to indicate the maximum operating temperature for a grease since some greases oxidize or decompose rapidly at temperatures below the dropping point. Dropping point is of little significance to the grease user but it is of significant value to the grease maker as means of quality control.

Oxidation Stability

Reaction with oxygen in the air, which is accelerated with higher temperatures, is one of the main factors limiting the life of bearing greases. This reaction

ultimately results in drying and hardening of the grease with total loss of lubricating properties.

The standard test used to measure the oxidation stability of grease is the Oxygen Bomb Method (ASTM D-942). In this test, the rate of absorption of oxygen by the grease at 210°F (99°C) and 110 PSI is recorded. This test is conducted under static conditions and is intended only to be useful in estimating the shelf life of greases. However, it has been found that greases which show low oxygen absorption usually perform reasonably well in service.

Water Resistance

Water resistance varies with the different types of greases. Most sodium soap greases emulsify and thin out when mixed with water. Other types are less affected but their resistance to washout varies with the viscosity of the oil and the amount and type of thickener. No lubricating grease is completely water resistant. Even those classed as water insoluble or water resistant can be washed out of a bearing if exposed to large volumes of water.

The ability of a grease to withstand water washout from a bearing is determined by ASTM Method D-1264. A ball bearing with a specified quantity of the test grease is mounted in a housing with specified clearances to allow entry of water from a jet. After one hour of operation at 600 RPM with the water at a controlled temperature impinging on the housing at a specified rate, the bearing is reweighed and the amount of grease lost is determined.

Shear Stability

(Mechanical Stability)

This is the resistance of a grease to structural breakdown when subjected to the shearing action of being worked.

Two grease working tests are used to measure softening of grease due to working. ASTM Method D-217, described earlier under Consistency, forces the grease through a perforated plate at a rate of 60 times per minute. The Shell Roll Test subjects the grease to the working action of a roll inside a rotating cylinder. Penetration values are determined before and after rolling. The degree of softening that results from working is important from the aspect of leakage from the bearing. However, the results cannot be correlated to bearing performance since greases which have appeared unsatisfactory in these tests have been found to provide very satisfactory bearing performance.

Oil Separation

Most greases show some tendency to allow oil separation in certain circumstances. During storage, depressions in the grease surface or voids collect oil.

This separation increases with higher storage temperatures as the viscosity of the oil phase is lowered. Oil separation, unless excessive, is not reason for rejection of a rolling bearing grease. Five percent is typically permitted. Usually the separated oil can be easily stirred back into the grease body.

The standard test method for determining oil separation from grease during storage is ASTM D-1742. This is a simple test where the sample is placed on a sieve strainer in a pressure cell with inlet air pressure maintained at 0.25 PSI. The test is conducted at 77°F (25°C) and after 24 hours the separated oil that has collected on the bottom of the cell is weighed and expressed as a percentage by weight of the original sample. This test is only intended to measure the tendency of a grease to separate oil during storage. It is not intended to predict the stability of grease under dynamic service conditions.

Channeling

Channeling is a term referring to the tendency of a grease to separate and form a channel after the passage of the balls and cage around the ball race. Some greases channel very little and flow back rapidly to fill the voids left by the rotating elements to cause higher torque and higher operating temperatures from the shear stresses within the lubricant. Poor channeling characteristics can make some greases unsatisfactory for high speed operation when a channeling type grease will provide minimum torque and heat rise. Channeling type greases are usually of NLGI No. 3 or No. 4 consistency.

Special Properties

There are many special grease formulations to meet a variety of unusual requirements. Special properties, which have been listed below, are often required in a grease. These special requirements may include:

1. Extra tackiness or adhesiveness to resist leakage or throw-out.
2. Proper structure for sealing to exclude contaminants.
3. Resistance to the action of certain chemicals.
4. Resistance to the action of solvents.
5. Electrical conductivity.
6. Resistance to the effects of nuclear radiation.
7. Resistance to the effects of high vacuum.
8. Non-toxic for use where there may be contact with food.
9. High oil bleed rates \geq 2.5% for machined and guided cages

Operating Conditions

Low Temperature

Oils and greases tend to thicken and resist flow as temperatures are decreased. For oil lubricated bearings

operating at cold temperatures, an oil that has a sufficiently low pour point to remain fluid at the low temperature and the proper viscosity for the operating temperature should be chosen. If the oil is subjected to low temperature start-up but operates at higher temperatures, a high viscosity index is desirable.

Usually the most important consideration in selecting a grease for low temperature operation is start-up torque. Some greases may function satisfactorily during operation but require excessive torque for start-up. Starting torque is not a function of the consistency or the channeling properties of a grease. It appears to be a function of the individual properties of the grease and is difficult to measure. Experience alone will show whether one grease is better than another in this respect. Greases formulated with synthetic oils are available which provide very low starting and running torque at temperatures as low as -100°F (-73°C). Generally, a correctly selected grease provides lower torque than an oil.

High Temperature

In oil lubricated bearing applications where ambient temperatures are high, such as in ovens, some means of cooling is usually necessary to avoid excessive bearing temperatures and premature lubricant failure. Some of the commonly used methods for decreasing the oil temperature are cooling coils, water jackets, oil cooling tanks, cooling discs, and fans.

The rate of oxidation of lubricating fluids increases rapidly with temperature rise. As mentioned earlier, the rate of oxidation doubles for each 18°F (10°C) temperature rise above 140°F (60°C). Above 250°F (121°C), petroleum oils tend to oxidize rapidly and sometimes it becomes necessary to use special petroleum oils or synthetic oils to increase the service life of the lubricant.

Where the only heat is that generated by the bearing, temperature rise can usually be held to a reasonable level by the use of a suitable lubricant in proper quantity.

The high temperature limit for greases, i.e. the maximum temperature at which a grease will provide a reasonable life in a non-relubricable bearing, is largely a function of the oxidation stability of the fluid and the thickener. The oxidation process is greatly accelerated with increasing temperature. Another factor is evaporation of the fluid phase. Also, greases thin out at high temperatures. If the grease consistency becomes too soft at operating temperatures there may be leakage from the bearing.

High Speeds

Small size anti-friction bearings are often successfully grease lubricated at high speeds. Larger sizes usually require oil to remove heat as well as to lubricate.

Where extensive cooling is required in high speed and heavily loaded bearings operating with high frictional heat, oil jets and circulating systems should be considered. For small and medium size bearings rotating at high speeds, an oil circulating system, drip feed or oil mist is satisfactory.

With other influences being equal, increasingly lower viscosities are needed with increasing speeds. The quantity of oil needed for successful operation becomes greater with increasing temperature, load, speed, and bearing size.

Extreme Pressures

Various extreme pressure agents are compounded into some greases and oils. These include additives such as sulfur, phosphorus, and chlorine compounds, graphite, and molybdenum disulfide. However, such additives are generally not required in anti-friction bearing lubricants and should be avoided unless their use is dictated by other associated equipment such as gears.

For most applications, higher viscosity oils are required to prevent metal to metal contact if pressures are higher than normal or if shock loading occurs. In cases where heavily loaded bearings operate at high speeds, the selection of oil viscosity must be a compromise between a heavy oil which is desirable for heavy loading and a light oil which is desirable for high speeds.

Wet Conditions

Whenever possible, an anti-friction bearing should be protected from water and moisture to avoid corrosion. Even slight corrosion on the internal surfaces may initiate bearing failure.

Ball and roller bearings are, however, often used successfully where moisture is present. The presence of moisture will affect the choice of a grease with the selection depending upon the quantity of moisture present.

Water soluble sodium base greases will form a non-corrosive emulsion when mixed with a limited quantity of water. However, agitation is necessary to form this emulsion. If water should enter an idle bearing, the bearing may become corroded. There is a limit to the amount of water which a water soluble grease can absorb and still protect the bearing surfaces.

A water resistant grease, such as a lithium base grease that contains an effective rust inhibitor should be used where large amounts of water are present. The term "water resistant grease" is actually a misnomer since no grease will totally resist large amounts of water for extended periods.

Slow moving bearings can be packed full of a cohesive, water resistant grease formulated with a very heavy oil to afford maximum protection against large amounts of water. Where wet conditions are so severe that satisfactory protection cannot be provided by a lubricant, it is sometimes necessary to use bearings fabricated of special corrosion resistant alloys or bearings with corrosion resistant coatings.

Fretting

Anti-friction bearings are sometimes damaged by a wear effect that is variously called fretting corrosion, fretting, friction oxidation and false brinelling. This effect evidences itself by the formation of rust-like wear debris and the formation of wear spots.

Fretting can occur in bearings subjected to vibration, vibratory loads, or oscillation of small amplitudes. It is sometimes seen in the bearings of idle machinery that has been subjected to the vibrations of nearby machines. The wear spots can be recognized as depressions or indentations in the races at the points where they have been in contact with the balls or rolls. If allowed to progress, the wear in these contact areas will become so extensive as to prevent functioning of the bearings.

Fretting can be eliminated or minimized by the selection of a lubricant which has good feed ability. Low viscosity oils minimize fretting to a greater extent than oils of higher viscosities.

With grease lubrication in applications where fretting is a problem, it is good general practice to use a soft grease such as an NLGI 0 or 1 grade or a harder grease which tends to soften considerably upon working.

Dust and Dirt

A high percentage of ball and roller bearing troubles can be attributed to foreign matter entering the bearing after mounting. Because anti-friction bearings are highly sensitive to dust and dirt, elaborate protective devices are necessary in some applications.

Oil lubricated bearings are generally protected from foreign particle contamination by the use of oil filters and the properly designed seals required in oil lubricated systems.

Grease in sealed and shielded bearings can provide an effective barrier against dust and dirt. Where the bearings operate in dusty or dirty atmosphere the grease should be chosen with its sealing properties in mind. Such a product should have good resistance to structural break-down on working. Usually, the stiff consistency of an NLGI Grade 3 grease will provide a good sealing barrier.

Operating Temperature Range

The temperature range over which a grease can be used depends on the type of base oil and thickener used as well as the additives. The lower temperature limit; i.e., the lowest temperature at which the grease will allow the bearing to be started up without difficulty, is determined by the base oil and its viscosity. The upper temperature limit is governed mainly by the type of thickener and indicates the maximum temperature at which the grease will provide lubrication for a bearing. It should be remembered that a grease will *age* (*deteriorate*) and oxidize with increasing rapidity as the temperature increases and that oxidation products have a detrimental effect on lubrication. The upper temperature limit should not be confused with the *grease dropping point* quoted by lubricant manufacturers as this value only indicates the temperature at which the grease loses its consistency and becomes fluid.

The following table gives the operating temperature ranges for the types of grease normally used for rolling bearing lubrication. The values are based on extensive testing and are valid for commonly available greases having a mineral oil base and no EP (*extreme pressure*) additives.

Operating Temperature Ranges for Mineral Oil-Based Greases

Grease Type (thickener)	Recommended Operating Temperature Range			
	°C		°F	
Lithium base	-30	to 110	-22	to 230
Lithium complex	-20	140	-4	284
Sodium base	-30	80	-22	176
Sodium complex	-20	140	-4	284
Calcium base	-10	60	14	140
Calcium complex	-20	130	-4	266
Barium complex	-20	130	-4	266
Aluminum complex	-30	110	-22	230
Inorganic thickeners (bentonite, silica gel, etc.)	-30	130	-22	266
Polyurea	-30	140	-22	284

Greases based on synthetic oils; e.g., ester oils, synthetic hydrocarbons or silicone oils, may be used at temperatures above and below the operating temperature range of mineral oil-based greases. If grease-lubricated bearings are to operate at such temperatures, MRC Bearings Applications Engineering should be contacted for advice.

Example

A deep groove ball bearing, the bore diameter (d) of which is 100 mm rotates at 2000 r/min. The operating temperature varies between 60 and 70°C. What lubricating interval should be expected?

Follow the line from 2000 on the x-axis of the diagram to the curve $d = 100$ mm. Then follow a line at right angles to the first from the point of intersection to the y-axis and across to the value 6500 in the t_{ia} column (radial ball bearings). The lubricating interval is therefore 6500 operating hours.

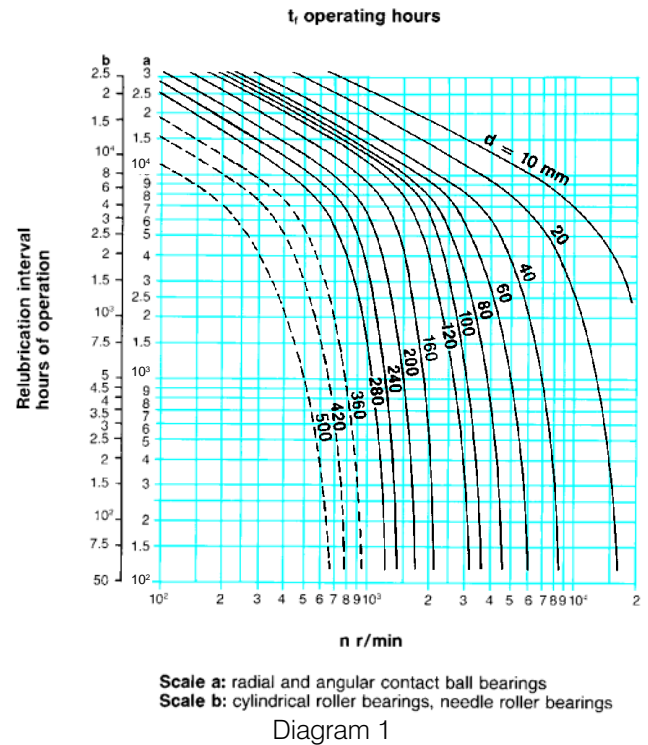

Relubrication Interval—Grease

The period during which a grease lubricated bearing will function satisfactorily without relubrication is dependent on the bearing type, size, speed, operating temperature and the grease used. The relubrication intervals (hours of operation) obtained from Diagram 1 are valid for bearings in stationary machines where loading conditions are normal. The diagram is based on the use of an age-resistant, average quality grease and is valid for bearing temperatures of + 70°C measured on the outer ring. The intervals should be halved for every 15°C increase above + 70°C, but the maximum permissible operating temperature for the grease should obviously not be exceeded. It should be noted, however, that relubrication intervals may vary significantly even where apparently similar greases are used. For small bearings, particularly deep groove ball bearings, the relubrication interval is often longer than the life of the bearing application. Relubrication is not, therefore, normally required. In such cases, ball bearings fitted with shields or seals and which are "lubricated-for-life" may be used.

Where there is a risk of the grease becoming contaminated the relubrication intervals should be reduced. This reduction also applies to applications where the grease is required to seal against moisture, e.g. bearings in papermaking machines, where water runs over the bearing housings, should be relubricated once a week.

Relubrication

The amount of grease needed for relubrication can be obtained from

$$G_p = 0.005 D B$$

where

G_p = grease quantity, g

D = bearing outside diameter, mm

B = total bearing width, mm

When operating conditions are such that relubrication can be carried out at infrequent intervals, it is sufficient if the bearing housing is accessible and can be opened easily. The cap of split housings and the cover of one-piece housings can usually be taken off to expose the bearing. After removing the used grease, fresh grease should first be packed between the rolling elements.

Where more frequent relubrication is required provision should be made for regreasing; preferably a grease nipple should be fitted to the housing. A grease gun (lubricator) can then be used. To ensure that fresh grease actually reaches the bearing and replaces the old grease, the lubrication duct in the housing should either feed the grease adjacent to the outer ring side face, or, better still, into the bearing.

After a number of such relubrications the housing should be opened and the used grease removed before fresh grease is added.

Relubrication Intervals—Oil

The frequency at which the oil must be changed is mainly dependent on the operating conditions and on the quantity of oil used.

Where oil bath lubrication is employed it is normally sufficient to change the oil once a year, provided the bearing temperature does not exceed 50°C (120°F) and there is no contamination. Higher temperatures or more arduous running conditions necessitate more frequent changes, e.g. at a temperature of 100°C (220°F) the oil should be changed every 3 months.

For circulating oil systems the period between complete oil changes is dependent on how often the oil is circulated over a given period of time and whether it is cooled, etc. The most suitable period can generally only be determined by trial runs and frequent examination of the oil. The same practice also applies to oil jet lubrication.

In oil mist lubrication, most of the oil is lost, as it is conveyed to the bearing only once.

Bearing Cleaning

New bearings should be cleaned only if they have been exposed to dirt after removal from their package or lubricated with an oil or grease that is incompatible with the preservative. (See Compatibility of Lubricants, pg. 298). Bearings which have been in service and require cleaning due to accumulated dirt or deteriorated lubricant may be cleaned as follows: All cleaning operations should be done in a dirt free area and only clean solvents of good quality should be used. Light transformer oils, spindle oils, or automotive flushing oils are suitable for cleaning bearings but oils heavier than SAE 10 motor oils are not recommended. The use of chlorinated solvents of any kind is not recommended in bearing cleaning operations because of the rust hazard involved. The use of compressed air for blowing dirt out of bearings and drying solvents is not recommended unless the air system is filtered to remove moisture and dirt. Bearings should never be spun at high speed by a stream of compressed air during cleaning as this may cause damage to the balls and raceways.

Cleaning Unmounted Used Bearings

Place bearings in a wire or mesh basket and suspend the basket in a suitable container of clean petroleum solvent or kerosene. Allow them to soak, preferably overnight or longer, until all hard deposits have softened. Bearings which contain badly oxidized grease may require soaking in hot, light oil (200° to 240°F) to soften the deposits. The basket should be agitated slowly through the oil from time to time. After deposits have softened, the bearings should be immersed in solvent for cleaning. In extreme cases, boiling in emulsified cleaners (i.e. grinding, cutting, or floor cleaning compounds) may be more effective to soften hard deposits. A stiff brush may be used to dislodge solid particles. If hot emulsion solutions have been used, it is important that all entrapped water be removed from the bearings. This may be accomplished by draining and slowly rotating the individual bearings while hot until the water has been completely evaporated. A more preferable method of removing entrapped water after draining is to spin the bearings in a water displacing type rust preventive oil. After removing the water, the bearings should immediately be immersed in clean petroleum solvent for further cleaning. After the used bearings have been thoroughly cleaned, their condition may be judged by hand. A light hand thrust should be applied against one bearing ring while slowly rotating the other ring. The degree of smoothness felt in rotation will indicate whether the bearing is satisfactory for further service. Bearings which are satisfactory for further service should be immediately rotated in light oil to displace the solvent. Those which will not be installed immediately should be coated with a good rust preventive oil and wrapped in clean oil-proof paper.

Cleaning Mounted Used Bearings

For cleaning bearings without removing them from their mounted assembly, hot, light oil at 180°F (82°C) may be flushed through the housing while the shaft or spindle is slowly rotated. In cases of badly oxidized grease and oil, hot water emulsions can be used in place of flushing oil. The solution should be drained thoroughly and the housing flushed with hot, light oil. The shaft should be rotated slowly throughout these operations.

In some cases where deposits are extremely difficult to remove, an intermediate flushing with a mixture of alcohol and light petroleum solvent after the emulsion treatment may be helpful. The flushing oil should be drained completely and oil passages checked to make sure they are not clogged before adding new lubricant.

If the bearing is lubricated with grease, new grease may be forced through the bearing to purge the old grease and contaminants. This may be done, however, only if contamination is not severe and vent openings are provided in the housing for exhausting the old grease. After purging with grease, the bearings should be operated for about ten minutes before the vent plugs are replaced to avoid serious over-heating of the bearing due to churning of excess grease.

Cleaning Sealed or Shielded Used Bearings

Bearings which have non-removable double shields or seals cannot be cleaned. These bearings are normally inspected and reused or rejected on the basis of smoothness and looseness.

Bearings having one seal or one shield may be cleaned satisfactorily by the methods outlined here. Bearings having two shields that are held in place by snap rings can be cleaned and regreased by carefully removing the shields and reinstalling them.

Bearings having two removable rubber seals can be cleaned and regreased if care is exercised in removing and reinstalling the seals. The best procedure for removing the seal is to insert a thin, knife-like blade between the O.D. of the seal and the seal groove in the outer ring, then slowly work around the periphery of the seal, working the seal from the groove. It is important to work around the periphery rather than exert too much pressure at one point which may damage the seal. Usually the seal can be removed without damage.

Things You Should Know About Lubrication

MRC bearings that have seals or shields are generally lubricated for the life of the bearing. Bearings that do not have seals or shields are protected from corrosion by coating the bearing with a preservative. The preservative is compatible with petroleum base oils and

lubricants. It is not necessary to remove the preservative from the bearing surfaces when the bearing will be lubricated with either a petroleum base oil or grease.

It is possible that either synthetic oil or greases compounded with synthetic oils, will not be compatible with a petroleum base preservative. It is recommended that the preservative be removed from the bearing surfaces before lubricating with either of these products. Synthetic hydrocarbons are an exception. It is also possible that greases compounded with a polyurea thickener may cause excessive grease softening due to incompatibility with a petroleum base preservative.

Synthetic oils and greases compounded with synthetic oils are classified as special condition lubricants. They are usually not the best choice for operating conditions that fall within the capability of petroleum base lubricants. They are expensive and lack some of the desirable lubricating qualities of petroleum base lubricants. Synthetic hydrocarbon may be an exception.

Because machined phenolic or metal separators occupy a considerable amount of the space between the bore of the outer ring and the OD of the inner ring in a bearing, special care must be exercised when introducing grease into these bearings to ensure that it is uniformly distributed in the bearing. Operation of the bearing will eventually uniformly distribute the grease, but it is possible to initiate a heating-type failure or to cause damage to the active surfaces in the bearing before this occurs. This precaution is especially important when there is a close running clearance between the separator and one of the rings. One method of introducing grease between the rings and the separator is to use a plastic bag. If grease is sealed in a plastic bag and a small opening is cut across one of the corners, the bag can be inserted between the separator and either ring. Grease can then be forced into the bearing by squeezing it from the bag.

In applications where either water or air is used to dissipate heat from the bearing cavity, care must be exercised not to create a significant temperature differential between the bearing inner ring and outer ring. Some cooling methods, i.e. water jacketed housings, very efficiently dissipate heat from the housing and outer ring of the bearing, but have little effect on the shaft and bearing inner ring. Under these conditions, internal clearance in the bearing is removed as the result of thermal expansion of the inner ring and thermal contraction of the outer ring. The loss of internal clearance can result in premature bearing failures due to a significant increase in ball and race stresses, and also due to excessive heat generation. One way to avoid this problem is to circulate and cool the oil.

Compatibility and Storage

It is important when relubricating bearings, not to mix different types of greases or oils. Mixing greases often causes the mixture to become either softer or stiffer. Incompatibility results when the mixture is too soft or too stiff to effectively lubricate the bearing. The mixing of the same type of grease or oil from two different manufacturers can also cause a performance loss unless the manufacturers use the same additives.

There are several environmental considerations when selecting an area for storing bearings. The shelf life of the grease or preservative can be significantly shortened if bearings are stored in an unsatisfactory environment. Because both temperature and humidity accelerate the deterioration of either grease or a preservative, bearings should be stored at a temperature not greater than 80°F (27°C) and at a humidity not exceeding 55 percent. It is also desirable to select an area where there is not a great fluctuation in temperature that might produce condensation. Also, in order to reduce the likelihood of bearings being held in storage for excessively long periods of time, bearing stocks should be rotated to make certain that the oldest bearings in stock are used first.

Lubrication Methods

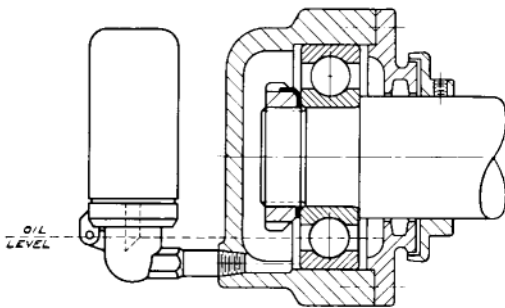

Figure 1

Oil Bath Lubrication

A simple oil bath method is satisfactory for low and moderate speeds. The static oil level should not exceed the center line of the lowermost ball or roller. A greater amount of oil can cause churning which results in abnormally high operating temperatures. Systems of this type generally employ sight gages to facilitate inspection of the oil level.

Figure 1 shows a constant level arrangement for maintaining the correct oil level.

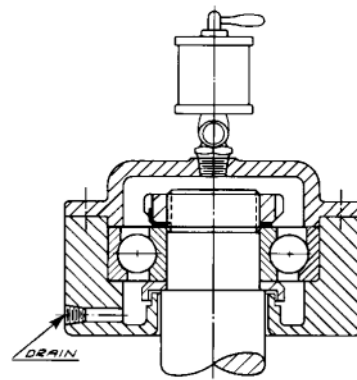

Figure 2

Drip Feed Lubrication

This system is widely used for small and medium ball and roller bearings operating at moderate to high speeds where extensive cooling is not required. The oil, introduced through a filter-type, sight feed oiler, has a controllable flow rate which is determined by the operating temperature of the bearings.

Figure 2 illustrates a typical design and shows the preferred location of the oiler with respect to the bearings.

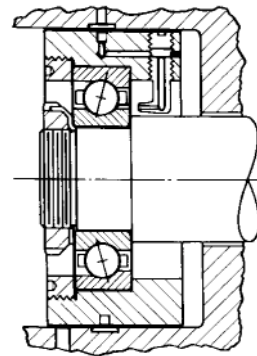

Figure 3

Forced Feed Circulation

This type of system uses a circulating pump and is particularly suitable for low to moderate speed, heavily loaded applications where the oil has a major function as a coolant in addition to lubrication. If necessary, the oil can be passed through a heat exchanger before returning to the bearing. Entry and exit of the oil should be on opposite sides of the bearing. An adequate drainage system must be provided to prevent an excess accumulation of oil. Oil filters and magnetic drain plugs should be used to minimize contamination.

In applications of large, heavily loaded, high speed bearings operating at high temperatures, it may be necessary to use high velocity oil jets. In such cases the use of several jets on both sides of the bearing provides more uniform cooling and minimizes the danger of complete lubrication loss from plugging. The jet stream should be directed at the opening between the cage bore and inner ring O.D., see Figure 3. Adequate scavenging drains must be provided to prevent churning of excess oil after the oil has passed through the bearing. In special cases, scavenging may be required on both sides of the bearing.

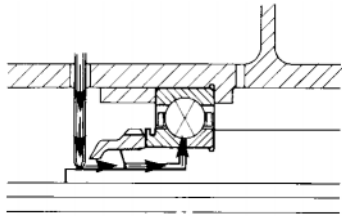

Figure 4

At extremely high speeds, the bearing tends to reject the entry of sufficient oil to provide adequate cooling and lubrication with conventional oil jet and flood systems. Figure 4 shows an under-race lubrication system with a 9000 series bearing having a split inner ring with oil slots. This method insures positive entrance of oil into the bearing to provide lubrication and cooling of the inner ring.

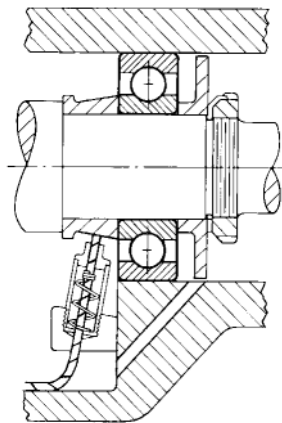

Figure 5

Wick Feed Lubrication

Wick oilers function either by gravity or capillary action to transfer a small quantity of filtered oil from a reservoir to the bearing. Wick feed is satisfactory for high speed operation with no danger of excessive oil churning. Attention must be given to wicks to assure that they are not clogged and they must be replaced occasionally.

Figure 5 shows an arrangement whereby the wick conveys oil by capillary action to a rotating flinger where it is thrown off by centrifugal force and drains back through the bearing.

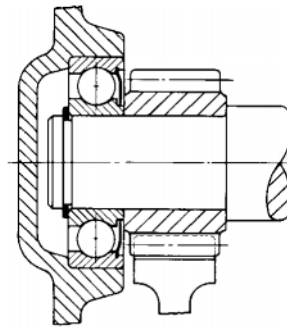

Figure 6

Oil Splash Lubrication

This method of lubrication is used mainly in gear boxes where the gear oil splash is used to lubricate the bearings.

In applications where the oil splash is heavy, shielded bearings are sometimes used to reduce the amount of oil reaching the bearing to prevent heating from excessive churning. See Figure 6.

In applications where normal splash does not provide adequate lubrication, oil feeder trails should be designed into the gear case to direct oil into the bearings.

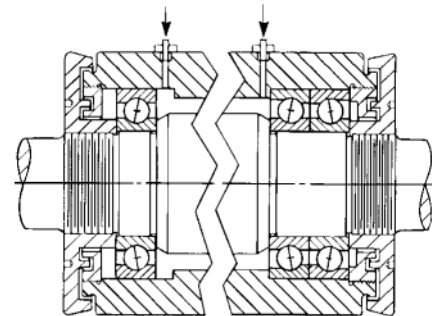

Figure 7

Oil Mist Lubrication

Oil mist systems, see Figure 7, are usually reserved for high speed applications. In mist lubrication systems, the oil is atomized and transported in an airstream through tubing to the bearings. Bearings are constantly fed with an optimum quantity of oil thus minimizing bearing heating due to oil churning. While not as effective as flood lubrication for heat removal, mist lubrication does provide some cooling from the continuous forced circulation of air. A rule of thumb on the use of oil mist is obtained from the formula $K < 10^9$. $K = DNL$. D = bearing bore in mm. N = inner ring speed RPM. L = load in pounds.

Systems can be designed so that a positive pressure is maintained within the housing thereby preventing the entrance of contaminants.

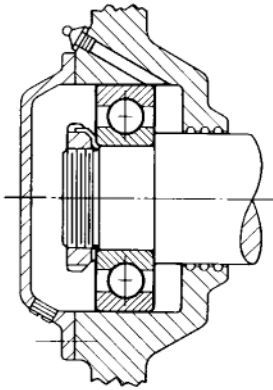

Figure 8

Regreaseable Mounting

Recommended for moderate speeds and loads. Where prelubricated sealed bearings are not suitable for some reason, consideration must be given to use of an open type bearing with provision for relubrication. The grease plug at the bottom should be removed while the grease is being inserted through the fitting at the top. The direction of flow tends to remove the old grease.

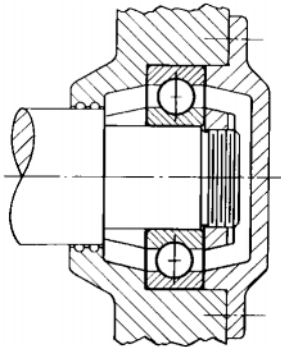

Figure 9

High Temperature Grease Mounting

The life of permanently lubricated installations at high temperatures is a function of the volume of grease present and the design of the mounting. Note that ample grease space has been provided and that the configuration of parts adjacent to the bearing is such as to urge the lubricant into contact with the active bearing parts.

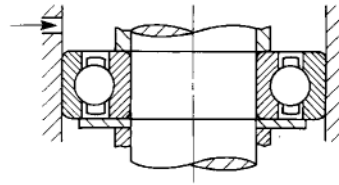

Figure 10

Deep Groove Ball Bearings on Vertical Shaft

In vertical applications where grease is admitted above the bearing, the bearing should be provided with a shield on the lower side, or a separate plate, as shown in figure 10, to retain the grease.

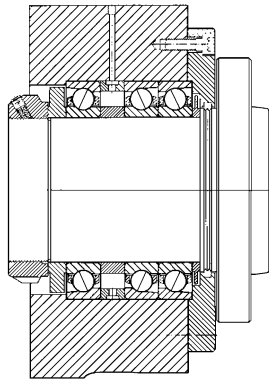

Figure 11

Grease Lubrication For Duplex Arrangements

For duplex mountings it is important that all bearings in the set receive an adequate supply of grease. Typical arrangements to accomplish this are shown above. In Figure 11, the spacer between the outer rings is provided with a circumferential groove and radial holes so that grease applied through the grease fitting and

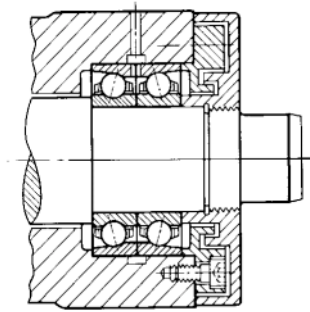

Figure 12

hole in the housing is directed between the bearings. In Figure 12, the bearing outer rings are slotted on the mating faces while the housing has a circumferential groove, grease fitting and hole, thus allowing grease to be applied to both bearings.

NOTES

Bearing Frequency Data

Vibration monitoring is becoming an important tool in preventive maintenance of equipment. Vibration monitoring can detect abnormalities in equipment components and indicate their replacement before a catastrophic failure occurs. This reduces expensive unplanned breakdown and loss of production.

To assist you in this monitoring, the following pages include frequency data for many of our popular bearing sizes. The bearing suffix code, which is printed on the bearing carton, identifies particular design features of the bearing. Although a change in suffix code for a bearing size normally causes little or no change in the frequency data for that bearing, if you are unable to match your suffix code to one in the chart and your application is sensitive, please call MRC Engineering for exact values.

The frequency data in the following pages is supplied based on a speed of one RPM. To obtain the frequency at your shaft or housing speed simply multiply the number given in the table by your speed.

Ex. What is the Inner ring ball pass frequency for a 100KR with inner ring rotation of 1,000 RPM.

Inner Ring frequency at 1 RPM = 5.0159 cycles/min (CPM) (from table)

Inner Ring frequency at 1,000 RPM = 5.0159 CPM × 1000

Inner Ring frequency at 1,000 RPM = 5015.9 CPM

MRC Ball Bearing Vibration Data
Data Based on a Speed of 1 RPM

MRC Bearing Services

Values in Cycles per Minute

Bearing Size	Suffix	Inner Rotation	Outer Rotation	Inner or Outer Ring Rotation		Inner Rotation	Outer Rotation
		Cage Speed Frequency (RPM)	Cage Speed Frequency (RPM)	Inner Ring Frequency	Outer Ring Frequency	Rolling Element Frequency	Rolling Element Frequency
100KR	0012	0.3730	0.6270	5.0159	2.9841	3.5324	3.5324
100KS	H501	0.3677	0.6323	4.4260	2.5740	3.5152	3.5152
101KR	XXXX	0.3865	0.6135	5.5216	3.4784	3.9830	3.9830
101KS	H501	0.3809	0.6191	4.9525	3.0475	3.9613	3.9613
102KR	H102	0.4034	0.5966	5.9660	4.0340	4.7502	4.7502
102KS	H501	0.3987	0.6013	5.4120	3.5880	4.7317	4.7317
102S	XXXX	0.3918	0.6082	4.8660	3.1340	4.4027	4.4027
103KR	H102	0.3974	0.6026	6.6286	4.3714	4.4812	4.4812
103KS	H501	0.4084	0.5916	5.9159	4.0841	5.2760	5.2760
103S	XXXX	0.3735	0.6265	4.3852	2.6148	3.7011	3.7011
104KR	H101	0.4017	0.5983	6.5815	4.4185	4.6932	4.6932
104KS	H501	0.3976	0.6024	5.4218	3.5782	4.6772	4.6772
104S	XXXX	0.3976	0.6024	5.4218	3.5782	4.6772	4.6772
105KR	0013	0.4153	0.5847	7.6006	5.3994	5.5070	5.5070
105KS	H501	0.4063	0.5937	5.9369	4.0631	5.1492	5.1492
105S	0005	0.4077	0.5923	5.3309	3.6691	5.2309	5.2309
106KR	0015	0.4189	0.5811	8.1350	5.8650	5.7921	5.7921
106KS	H501	0.4159	0.5841	6.4246	4.5754	5.7803	5.7803
106S	H502	0.4137	0.5863	5.8628	4.1372	5.6226	5.6226
107KR	0017	0.4213	0.5787	8.1020	5.8980	5.9590	5.9590
107KS	H502	0.4182	0.5818	6.4001	4.5999	5.9467	5.9467
107S	XXXX	0.4286	0.5714	6.8571	5.1429	6.8571	6.8571
108KR	0011	0.4293	0.5707	8.5605	6.4395	6.6672	6.6672
108KS	H501	0.4118	0.5882	5.8819	4.1181	5.4929	5.4929
108S	0C01	0.4339	0.5661	7.3599	5.6401	7.4267	7.4267
109KR	0008	0.4297	0.5703	9.1245	6.8755	6.7074	6.7074
109KS	0012	0.4203	0.5797	6.9559	5.0441	6.1172	6.1172
109S	XXXX	0.4398	0.5602	8.9638	7.0362	8.1797	8.1797
110KR	0022	0.4351	0.5649	9.6026	7.3974	7.2900	7.2900
110KS	0020	0.4267	0.5733	7.4525	5.5475	6.6777	6.6777
110M	0C01	0.4451	0.5549	10.5440	8.4560	8.9899	8.9899
110S	XXXX	0.4442	0.5558	8.8929	7.1071	8.8484	8.8484
111KR	0011	0.4317	0.5683	9.6615	7.3385	6.8942	6.8942
111KS	0020	0.4288	0.5712	7.4252	5.5748	6.8830	6.8830
111S	XXXX	0.4431	0.5569	8.9107	7.0893	8.6703	8.6703
112KR	0011	0.4361	0.5639	10.1505	7.8495	7.3870	7.3870
112KS	0017	0.4283	0.5717	7.4320	5.5680	6.8308	6.8308
112S	XXXX	0.4444	0.5556	8.8889	7.1111	8.8889	8.8889
113KR	0011	0.4400	0.5600	10.6408	8.3592	7.8791	7.8791
113KS	0015	0.4327	0.5673	7.9429	6.0571	7.2895	7.2895
113M	XXXX	0.4427	0.5573	11.7040	9.2960	8.6065	8.6065
113S	XXXX	0.4444	0.5556	8.8889	7.1111	8.8889	8.8889
114KR	0013	0.4409	0.5591	11.1818	8.8182	7.9858	7.9858
114KS	0016	0.4294	0.5706	7.4172	5.5828	6.9455	6.9455
114S	XXXX	0.4464	0.5536	8.8576	7.1424	9.2209	9.2209
115KR	0020	0.4440	0.5560	11.6756	9.3244	8.4419	8.4419
115KS	0020	0.4332	0.5668	7.9358	6.0642	7.3467	7.3467
115S	XXXX	0.4380	0.5620	7.8673	6.1327	7.9471	7.9471
116KR	0004	0.4404	0.5596	11.7522	9.2478	7.9562	7.9562
116KS	0007	0.4303	0.5697	7.4060	5.5940	7.0348	7.0348
116S	0006	0.4419	0.5581	8.3721	6.6279	8.4837	8.4837
117KR	XXXX	0.4435	0.5565	12.2427	9.7573	8.3566	8.3566
117KS	0009	0.4335	0.5665	7.9303	6.0697	7.3912	7.3912
117M	XXXX	0.4379	0.5621	11.8045	9.1955	7.9248	7.9248
117S	XXXX	0.4379	0.5621	7.8697	6.1303	7.9248	7.9248
118KR	0006	0.4403	0.5597	11.7588	9.2462	7.9243	7.9243
118KS	0010	0.4310	0.5690	7.3973	5.6027	7.1061	7.1061
118S	XXXX	0.4405	0.5595	7.8334	6.1666	8.2799	8.2799
119KR	XXXX	0.4362	0.5638	11.2766	8.7234	7.4360	7.4360
119KS	XXXX	0.4372	0.5628	8.4425	6.5575	7.8319	7.8319
119S	XXXX	0.4378	0.5622	7.8704	6.1296	7.9182	7.9182
120KR	XXXX	0.4451	0.5549	12.7633	10.2367	8.6434	8.6434

Values in Cycles per Minute

Bearing Size	Suffix	Inner Rotation	Outer Rotation	Inner or Outer Ring Rotation		Inner Rotation	Outer Rotation
		Cage Speed Frequency (RPM)	Cage Speed Frequency (RPM)	Inner Ring Frequency	Outer Ring Frequency	Rolling Element Frequency	Rolling Element Frequency
120KS	H502	0.4365	0.5635	7.8890	6.1110	7.7471	7.7471
120M	XXXX	0.4194	0.5806	10.4509	7.5491	6.0419	6.0419
120R	0011	0.4347	0.5653	11.3056	8.6944	7.2895	7.2895
121KR	XXXX	0.4425	0.5575	12.2652	9.7348	8.2361	8.2361
121KS	XXXX	0.4371	0.5629	8.4434	6.5566	7.8238	7.8239
122KR	0010	0.4399	0.5601	11.7621	9.2379	7.9013	7.9013
122KS	H501	0.4348	0.5652	7.9129	6.0871	7.5376	7.5376
122R	0008	0.4351	0.5649	11.2971	8.7029	7.3267	7.3267
124KR	0008	0.4439	0.5561	12.2340	9.7660	8.4817	8.4817
124KS	H501	0.4391	0.5609	8.4129	6.5871	8.0941	8.0941
124M	XXXX	0.4283	0.5717	10.8622	8.1378	6.8308	6.8308
124R	0012	0.4352	0.5648	11.8600	9.1400	7.3573	7.3573
126KR	0012	0.4398	0.5602	12.3250	9.6750	7.8792	7.8792
126KS	H501	0.4375	0.5625	8.4381	6.5619	7.8701	7.8701
126M	0001	0.4289	0.5711	10.8506	8.1494	6.8920	6.8920
126R	0012	0.4404	0.5596	12.3105	9.6895	7.9689	7.9688
128KR	XXXX	0.4432	0.5568	12.2493	9.7507	8.3704	8.3704
128KS	XXXX	0.4365	0.5635	7.8890	6.1110	7.7471	7.7471
128M	XXXX	0.4294	0.5706	10.8406	8.1594	6.9455	6.9455
128R	0006	0.4401	0.5599	12.3168	9.6832	7.9514	7.9514
130KR	0004	0.4430	0.5570	12.2535	9.7465	8.3269	8.3269
130KS	XXXX	0.4323	0.5677	7.3805	5.6195	7.2464	7.2464
130R	0005	0.4401	0.5599	12.3168	9.6832	7.9373	7.9373
132KR	XXXX	0.4426	0.5574	12.2625	9.7375	8.2883	8.2883
132KS	XXXX	0.4365	0.5635	7.8890	6.1110	7.7470	7.7470
132M	0004	0.4303	0.5697	11.3939	8.6061	7.0347	7.0347
132R	0010	0.4399	0.5601	12.3220	9.6780	7.9239	7.9239
134KR	0006	0.4395	0.5605	11.7707	9.2293	7.8500	7.8500
134KS	XXXX	0.4299	0.5701	7.4119	5.5881	6.9878	6.9878
134R	0006	0.4400	0.5600	12.3209	9.6791	7.9131	7.9131
136KR	XXXX	0.4400	0.5600	12.3209	9.6791	7.9330	7.9330
136KS	XXXX	0.4379	0.5621	7.8697	6.1303	7.9247	7.9247
136R	0005	0.4398	0.5602	12.3252	9.6748	7.9026	7.9026
138KR	XXXX	0.4428	0.5572	12.8152	10.1848	8.2891	8.2891
138KS	XXXX	0.4355	0.5645	7.9029	6.0971	7.6242	7.6242
138R	0003	0.4373	0.5627	12.3802	9.6198	7.5663	7.5663
140KR	XXXX	0.4400	0.5600	12.3210	9.6790	7.9157	7.9157
140KS	XXXX	0.4315	0.5685	7.3902	5.6098	7.1644	7.1644
140R	XXXX	0.4381	0.5619	12.3624	9.6376	7.6794	7.6794
142R	XXXX	0.4359	0.5641	11.8466	9.1534	7.4078	7.4078
144KR	XXXX	0.4342	0.5658	11.8817	9.1183	7.2218	7.2218
144KS	XXXX	0.4348	0.5652	7.9128	6.0872	7.5385	7.5385
144R	0005	0.4379	0.5621	12.3663	9.6337	7.6544	7.6544
146R	XXXX	0.4387	0.5613	12.3494	9.6506	7.7555	7.7555
148KR	XXXX	0.4389	0.5611	12.3440	9.6560	7.7565	7.7565
148KS	XXXX	0.4378	0.5622	7.8705	6.1295	7.9169	7.9169
148R	XXXX	0.4391	0.5609	12.3387	9.6613	7.8195	7.8195
150R	XXXX	0.4396	0.5604	12.3290	9.6710	7.8784	7.8784
152KR	XXXX	0.4352	0.5648	11.8613	9.1387	7.2993	7.2993
152KS	XXXX	0.4375	0.5625	7.8755	6.1245	7.8701	7.8701
152R	XXXX	0.4400	0.5600	12.3201	9.6799	7.9331	7.9331
156KR	XXXX	0.4392	0.5608	12.3377	9.6623	7.7576	7.7576
156KS	XXXX	0.4388	0.5612	7.8573	6.1427	8.0432	8.0432
156R	XXXX	0.4399	0.5601	12.3220	9.6780	7.9208	7.9208
160KR	XXXX	0.4360	0.5640	11.8445	9.1555	7.3577	7.3577
160KS	XXXX	0.4373	0.5627	7.8773	6.1227	7.8537	7.8537
164KR	XXXX	0.4396	0.5604	12.3293	9.6707	7.7590	7.7590
164KS	XXXX	0.4405	0.5595	8.3930	6.6070	8.2799	8.2799
164R	XXXX	0.4402	0.5598	12.3165	9.6835	7.9552	7.9552
1800S	H501	0.4178	0.5822	6.4037	4.5963	5.9221	5.9221
1801S	H501	0.4278	0.5722	6.8666	5.1334	6.7788	6.7788
1802S	H501	0.4389	0.5611	7.8553	6.1447	8.0623	8.0623

MRC Ball Bearing Vibration Data
Data Based on a Speed of 1 RPM

MRC Bearing Services

Values in Cycles per Minute

Bearing Size	Suffix	Inner Rotation	Outer Rotation	Inner or Outer Ring Rotation		Inner Rotation	Outer Rotation
		Cage Speed Frequency (RPM)	Cage Speed Frequency (RPM)	Inner Ring Frequency	Outer Ring Frequency	Rolling Element Frequency	Rolling Element Frequency
1803S	H501	0.4446	0.5554	8.8865	7.1135	8.9137	8.9137
1804S	H501	0.4389	0.5611	7.8548	6.1452	8.0667	8.0667
1805S	H501	0.4432	0.5568	8.3523	6.6477	8.6861	8.6861
1806S	H501	0.4559	0.5441	9.7938	8.2062	11.2502	11.2502
1807S	H501	0.4613	0.5387	10.7744	9.2256	12.8362	12.8362
1808S	H501	0.4655	0.5345	11.7592	10.2408	14.4190	14.4190
1809S	H501	0.4615	0.5385	10.7709	9.2291	12.8954	12.8954
1810S	H501	0.4655	0.5345	11.7595	10.2405	14.4146	14.4146
1811S	H501	0.4625	0.5375	10.7500	9.2500	13.2583	13.2583
1812S	H501	0.4655	0.5345	11.7592	10.2408	14.4190	14.4190
1813S	H501	0.4630	0.5370	11.8151	10.1849	13.4213	13.4213
1814S	H501	0.4653	0.5347	12.8336	11.1664	14.3254	13.3254
1815S	H501	0.4673	0.5327	13.8500	12.1500	15.2294	15.2294
1816S	H501	0.4691	0.5309	13.8028	12.1972	16.1325	16.1325
1817S	H501	0.4634	0.5366	12.8794	11.1206	13.5726	13.5726
1818S	H501	0.4651	0.5349	13.3714	11.6286	14.2758	14.2758
1819S	H501	0.4668	0.5332	13.8640	12.1360	14.9790	14.9790
1820S	H501	0.4682	0.5318	14.3574	12.6426	15.6816	15.6816
1821S	H501	0.4696	0.5304	15.3817	13.6183	16.3843	16.3843
1822S	H501	0.4651	0.5349	13.3732	11.6268	14.2446	14.2446
1824S	H501	0.4677	0.5323	14.3732	12.6268	15.3949	15.3949
1826S	H501	0.4650	0.5350	13.3746	11.6254	14.2227	14.2227
1828S	H501	0.4672	0.5328	14.3846	12.6154	15.1961	15.1961
1830S	H501	0.4650	0.5350	13.3756	11.6244	14.2066	14.2066
1832S	H501	0.4669	0.5331	13.8600	12.1400	15.0503	15.0503
1834S	H501	0.4649	0.5351	13.3763	11.6237	14.1943	14.1943
1836S	H501	0.4667	0.5333	13.8664	12.1336	14.9388	14.9388
1838S	H501	0.4649	0.5351	13.3769	11.6231	14.1848	14.1848
1840S	H501	0.4665	0.5335	13.8714	12.1286	14.8510	14.8510
1844S	H501	0.4692	0.5308	14.8619	13.1381	16.1825	16.1825
1848S	H501	0.4662	0.5338	13.8791	12.1209	14.7208	14.7208
1852S	H501	0.4685	0.5315	14.8814	13.1186	15.8209	15.8209
1856S	H501	0.4672	0.5328	14.3845	12.6155	15.1980	15.1980
1860S	H501	0.4650	0.5350	13.3755	11.6245	14.2081	14.2081
1864S	H501	0.4669	0.5331	13.8599	12.1401	15.0519	15.0519
1868S	H501	0.4687	0.5313	14.8773	13.1227	15.8953	15.8953
1872S	H501	0.4702	0.5298	15.3632	13.6368	16.7383	16.7383
1876S	H501	0.4649	0.5351	13.3768	11.6232	14.1859	14.1859
1880S	H501	0.4665	0.5335	13.8714	12.1286	14.8521	14.8521
1884S	H501	0.4679	0.5321	14.3664	12.6336	15.5181	15.5181
1888S	H501	0.4692	0.5308	14.8618	13.1382	16.1837	16.1837
1892S	H501	0.4649	0.5351	13.3777	11.6223	14.1715	14.1715
1896S	H501	0.4662	0.5338	13.8790	12.1210	14.7218	14.7218
1900R	XXXX	0.4067	0.5933	6.5268	4.4732	4.8597	4.8597
1900S	H501	0.4008	0.5992	4.7938	3.2062	4.8408	4.8408
1901R	XXXX	0.4180	0.5820	6.9842	5.0158	5.5171	5.5171
1901S	H501	0.4118	0.5882	5.8819	4.1181	5.4932	5.4932
1902R	XXXX	0.4129	0.5871	7.0452	4.9548	5.2549	5.2549
1902S	H101	0.4077	0.5923	5.3309	3.6691	5.2312	5.2312
1902S	H501	0.4077	0.5923	5.3309	3.6691	5.2312	5.2312
1903R	XXXX	0.4203	0.5797	7.5360	5.4640	5.7727	5.7727
1903S	H501	0.4155	0.5845	5.8447	4.1553	5.7504	5.7504
1904R	XXXX	0.4070	0.5930	7.7095	5.2905	4.9509	4.9509
1904S	H501	0.4165	0.5835	6.4190	4.5810	5.8174	5.8174
1905R	XXXX	0.4327	0.5673	8.5093	6.4907	6.9067	6.9067
1905S	H501	0.4289	0.5711	6.8530	5.1470	6.8920	6.8920
1906R	XXXX	0.4363	0.5637	9.5829	7.4171	7.3422	7.3422
1906S	H501	0.4330	0.5670	6.2369	4.7631	7.3293	7.3293
1907R	XXXX	0.4416	0.5584	10.0512	7.9488	7.9869	7.9869
1907S	H501	0.4338	0.5662	6.7938	5.2062	7.4261	7.4261
1908R	XXXX	0.4407	0.5593	10.0673	7.9327	7.9186	7.9186
1908S	H501	0.4300	0.5700	6.8406	5.1594	6.9978	6.9978

Values in Cycles per Minute

Bearing Size	Suffix	Inner Rotation	Outer Rotation	Inner or Outer Ring Rotation		Inner Rotation	Outer Rotation
		Cage Speed Frequency (RPM)	Cage Speed Frequency (RPM)	Inner Ring Frequency	Outer Ring Frequency	Rolling Element Frequency	Rolling Element Frequency
1909R	XXXX	0.4468	0.5532	11.0648	8.9352	8.7971	8.7971
1909S	H501	0.4438	0.5562	6.1181	4.8819	8.7856	8.7856
1910R	XXXX	0.4442	0.5558	11.6725	9.3275	8.4310	8.4310
1910S	H501	0.4414	0.5586	7.2613	5.7387	8.4204	8.4204
1911R	XXXX	0.4443	0.5557	11.1148	8.8852	8.3983	8.3982
1911S	H501	0.4471	0.5529	8.8468	7.1532	9.3414	9.3414
1912R	XXXX	0.4481	0.5519	12.1416	9.8584	9.0357	9.0357
1912S	H501	0.4507	0.5493	9.3377	7.6623	10.0486	10.0486
1913R	XXXX	0.4515	0.5485	12.6166	10.3834	9.6718	9.6718
1913S	H501	0.4539	0.5461	10.3758	8.6242	10.7546	10.7546
1914R	XXXX	0.4468	0.5532	12.1710	9.8290	8.8229	8.8229
1914S	H501	0.4486	0.5514	9.3732	7.6268	9.6311	9.6311
1915R	XXXX	0.4497	0.5503	12.6562	10.3438	9.3535	9.3535
1915S	XXXX	0.4515	0.5485	9.8782	8.1268	10.2095	10.2095
1916R	XXXX	0.4524	0.5476	13.1430	10.8570	9.8834	9.8834
1916S	H501	0.4540	0.5460	10.3732	8.6268	10.7871	10.7871
1917R	XXXX	0.4485	0.5515	12.6844	10.3156	9.1262	9.1262
1917S	H501	0.4497	0.5503	9.3558	7.6442	9.8316	9.8316
1918R	XXXX	0.4472	0.5528	13.2672	10.7328	8.9273	8.9273
1918S	XXXX	0.4520	0.5480	9.8640	8.1360	10.3207	10.3207
1919R	XXXX	0.4531	0.5469	13.6730	11.3270	10.0347	10.0347
1919S	XXXX	0.4541	0.5459	10.3715	8.6285	10.8096	10.8096
1920R	XXXX	0.4494	0.5506	13.2144	10.7856	9.3520	9.3520
1920S	XXXX	0.4504	0.5496	9.8931	8.1069	9.9784	9.9784
1921R	XXXX	0.4517	0.5483	13.7065	11.2935	9.7509	9.7509
1921S	XXXX	0.4524	0.5476	10.4050	8.5950	10.4024	10.4024
1922R	XXXX	0.4566	0.5434	14.6706	12.3294	10.8354	10.8354
1922S	XXXX	0.4542	0.5458	10.3702	8.6298	10.8259	10.8259
1924R	XXXX	0.4521	0.5479	13.6975	11.3025	9.8823	9.8823
1924S	H501	0.4499	0.5501	10.4525	8.5475	9.8736	9.8736
1926R	XXXX	0.4512	0.5488	13.7188	11.2812	9.6710	9.6710
1926S	XXXX	0.4514	0.5486	9.8756	8.1244	10.1813	10.1813
1928R	XXXX	0.4542	0.5458	14.1907	11.8093	10.3066	10.3066
1928S	XXXX	0.4543	0.5457	10.3682	8.6318	10.8503	10.8503
1930R	XXXX	0.4495	0.5505	13.7634	11.2366	9.3523	9.3523
1930S	XXXX	0.4515	0.5485	10.4216	8.5784	10.2108	10.2108
1932R	XXXX	0.4521	0.5479	14.2448	11.7552	9.8823	9.8823
1932S	XXXX	0.4520	0.5480	9.8647	8.1353	10.3120	10.3120
1934R	XXXX	0.4548	0.5452	15.2657	12.7343	10.4129	10.4129
1934S	XXXX	0.4544	0.5456	10.3671	8.6329	10.8646	10.8646
1936R	XXXX	0.4506	0.5494	14.2853	11.7147	9.5793	9.5793
1936S	XXXX	0.4520	0.5480	10.4119	8.5881	10.3220	10.3220
1938R	XXXX	0.4531	0.5469	14.7658	12.2342	10.0348	10.0348
1938S	XXXX	0.4541	0.5459	10.3714	8.6286	10.8108	10.8108
1940R	XXXX	0.4494	0.5506	14.3148	11.6852	9.3521	9.3521
1940S	XXXX	0.4504	0.5496	9.8930	8.1070	9.9795	9.9795
1944S	H501	0.4542	0.5458	10.3701	8.6299	10.8270	10.8270
1948S	H501	0.4575	0.5425	11.3930	9.6070	11.6735	11.6735
1952S	H501	0.4514	0.5486	9.8757	8.1243	10.1803	10.1803
1956S	H501	0.4543	0.5457	10.3683	8.6317	10.8493	10.8493
1960S	H501	0.4493	0.5507	9.3621	7.6379	9.7582	9.7582
1964S	H501	0.4520	0.5480	9.8648	8.1352	10.3113	10.3113
1968S	H501	0.4544	0.5456	10.3672	8.6328	10.8638	10.8638
1972S	H501	0.4565	0.5435	10.8693	9.1307	11.4160	11.4160
1976S	H501	0.4541	0.5459	10.3714	8.6286	10.8107	10.8107
1980S	H501	0.4561	0.5439	10.8782	9.1218	11.2992	11.2992
1984S	H501	0.4579	0.5421	11.3845	9.6155	11.7873	11.7873
1988S	H501	0.4542	0.5458	10.3701	8.6299	10.8270	10.8270
1992S	H501	0.4559	0.5441	10.8819	9.1181	11.2504	11.2504
200R	XXXX	0.3460	0.6540	4.5779	2.4221	2.8509	2.8509
200S	H501	0.3809	0.6191	4.9525	3.0475	3.9613	3.9613
200SZZC	H401	0.3838	0.6162	4.9293	3.0707	4.0722	4.0722

MRC Ball Bearing Vibration Data
Data Based on a Speed of 1 RPM

MRC Bearing Services

Values in Cycles per Minute

Bearing Size	Suffix	Inner Rotation	Outer Rotation	Inner or Outer Ring Rotation		Inner Rotation	Outer Rotation
		Cage Speed Frequency (RPM)	Cage Speed Frequency (RPM)	Inner Ring Frequency	Outer Ring Frequency	Rolling Element Frequency	Rolling Element Frequency
201R	XXXX	0.3607	0.6393	5.1142	2.8858	3.1956	3.1956
201S	H501	0.3636	0.6364	4.4545	2.5455	3.3941	3.3941
201SZCC	H401	0.3647	0.6353	4.4472	2.5528	3.4243	3.4243
202M	XXXX	0.3730	0.6270	6.2699	3.7301	3.6832	3.6832
202R	H102	0.3872	0.6128	5.5154	3.4846	4.0490	4.0490
202S	H501	0.3812	0.6188	4.9500	3.0500	3.9729	3.9729
202SZCC	H401	0.3833	0.6167	4.9340	3.0660	4.0494	4.0494
203M	XXXX	0.3886	0.6114	6.7254	4.2746	4.2656	4.2656
203R	H102	0.3875	0.6125	5.5124	3.4876	4.0810	4.0810
203S	H501	0.3817	0.6183	4.9468	3.0532	3.9881	3.9881
203SZCC	H401	0.3837	0.6163	4.9305	3.0695	4.0659	4.0659
204M	0001	0.3815	0.6185	6.1847	3.8153	3.9835	3.9835
204R	0022	0.3971	0.6029	7.2342	4.7658	4.4902	4.4902
204R	0C02	0.3971	0.6029	7.2342	4.7658	4.4902	4.4902
204RDS	0022	0.3971	0.6029	6.6314	4.3686	4.4902	4.4902
204S	H501	0.3815	0.6185	4.9478	3.0522	3.9835	3.9835
204SFFC	H401	0.3850	0.6150	4.9203	3.0797	4.1165	4.1165
204SZCC	H401	0.3850	0.6150	4.9203	3.0797	4.1165	4.1165
205M	XXXX	0.3866	0.6134	6.7475	4.2525	4.1821	4.1821
205R	0032	0.4002	0.5998	7.1974	4.8026	4.6574	4.6574
205R	0028	0.4002	0.5998	7.1974	4.8026	4.6574	4.6574
205RDS	0028	0.4002	0.5998	6.5976	4.4024	4.6574	4.6574
205S	H501	0.3983	0.6017	5.4149	3.5851	4.7151	4.7151
205SFFC	0099	0.3866	0.6134	4.9072	3.0928	4.1821	4.1821
205SZCC	0027	0.3866	0.6134	4.9072	3.0928	4.1821	4.1821
206M	0012	0.3878	0.6122	7.3461	4.6539	4.2329	4.2329
206R	0014	0.4165	0.5835	8.1693	5.8307	5.6335	5.6335
206RDS	0032	0.4165	0.5835	8.1693	5.8307	5.6335	5.6335
206S	0129	0.3878	0.6122	4.8974	3.1026	4.2329	4.2329
206S	0055	0.3878	0.6122	4.8974	3.1026	4.2329	4.2329
206S	H501	0.3965	0.6035	5.4318	3.5682	4.6223	4.6223
206SFFC	0250	0.3878	0.6122	5.4318	3.5682	4.6223	4.6223
206SZCC	0025	0.3878	0.6122	5.4318	3.5682	4.6223	4.6223
207M	0022	0.3887	0.6113	7.3354	4.6646	4.2704	4.2704
207R	0020	0.4138	0.5862	8.2068	5.7932	5.4499	5.4499
207RDS	0017	0.4138	0.5862	8.2068	5.7932	5.4499	5.4499
207S	0118	0.3887	0.6113	4.8903	3.1097	4.2704	4.2704
207S	H201	0.3961	0.6039	5.4347	3.5653	4.6067	4.6067
207SFFC	0131	0.3887	0.6113	4.8903	3.1097	4.2704	4.2704
207SZCC	0024	0.3887	0.6113	4.8903	3.1097	4.2704	4.2704
208M	0012	0.3942	0.6058	7.2700	4.7300	4.5127	4.5127
208R	0024	0.4099	0.5901	8.2613	5.7387	5.2240	5.2240
208S	0154	0.3942	0.6058	5.4525	3.5475	4.5127	4.5127
208S	H201	0.3975	0.6025	5.4228	3.5772	4.6715	4.6715
208SFFC	0147	0.3942	0.6058	5.4525	3.5475	4.5127	4.5127
208SZCC	0017	0.3942	0.6058	5.4525	3.5475	4.5127	4.5127
209M	0022	0.3962	0.6038	7.8495	5.1505	4.6091	4.6091
209R	0023	0.4171	0.5829	8.1609	5.8391	5.6885	5.6885
209RDS	0025	0.4171	0.5829	8.7438	6.2562	5.6885	5.6885
209S	0071	0.3962	0.6038	5.4343	3.5657	4.6091	4.6091
209S	H201	0.4054	0.5946	5.9464	4.0536	5.0937	5.0937
209SFFC	0058	0.3962	0.6038	5.4343	3.5657	4.6091	4.6091
209SZCC	0018	0.3962	0.6038	5.4343	3.5657	4.6091	4.6091
210M	0016	0.4093	0.5907	8.8607	6.1393	5.3304	5.3304
210R	0014	0.4230	0.5770	9.2320	6.7680	6.1498	6.1498
210S	0071	0.4093	0.5907	5.9071	4.0929	5.3304	5.3304
210S	H201	0.4093	0.5907	5.9071	4.0929	5.3304	5.3304
210SFFC	0157	0.4093	0.5907	5.9071	4.0929	5.3304	5.3304
210SZCC	0009	0.4093	0.5907	5.9071	4.0929	5.3304	5.3304
211M	0017	0.4078	0.5922	8.8827	6.1173	5.2400	5.2400
211R	0C01	0.4105	0.5895	8.2532	5.7468	5.2505	5.2505
211S	0057	0.4078	0.5922	5.9218	4.0782	5.2400	5.2400

Values in Cycles per Minute

Bearing Size	Suffix	Inner Rotation	Outer Rotation	Inner or Outer Ring Rotation		Inner Rotation	Outer Rotation
		Cage Speed Frequency (RPM)	Cage Speed Frequency (RPM)	Inner Ring Frequency	Outer Ring Frequency	Rolling Element Frequency	Rolling Element Frequency
211S	H201	0.4078	0.5922	5.9218	4.0782	5.2400	5.2400
211SZZC	0004	0.4078	0.5922	5.9218	4.0782	5.2400	5.2400
212M	0005	0.4066	0.5934	8.3073	5.6927	5.1676	5.1676
212R	0012	0.4184	0.5816	9.3058	6.6942	5.7908	5.7908
212S	0064	0.4066	0.5934	5.9338	4.0662	5.1676	5.1676
212S	H201	0.4108	0.5892	5.8924	4.1076	5.4241	5.4241
213M	0001	0.4056	0.5944	8.9159	6.0841	5.1084	5.1084
213M	H201	0.4099	0.5901	8.8516	6.1484	5.3686	5.3686
213R	0016	0.4164	0.5836	9.3372	6.6618	5.6641	5.6641
213RDS	0013	0.4168	0.5832	8.7485	6.2515	5.6641	5.6641
213S	0010	0.4056	0.5944	5.9439	4.0561	5.1084	5.1084
213S	H201	0.4145	0.5855	6.4409	4.5591	5.6745	5.6745
213SFFC	0026	0.4056	0.5944	5.9439	4.0561	5.1084	5.1084
214M	0001	0.4186	0.5814	9.3026	6.6974	5.9789	5.9789
214M	H201	0.4104	0.5896	8.8433	6.1567	5.4043	5.4043
214R	0014	0.4210	0.5790	10.4214	7.5786	5.9886	5.9886
214RDS	0010	0.4210	0.5790	9.2635	6.7365	5.9886	5.9886
214S	0037	0.4104	0.5896	5.8955	4.1045	5.4043	5.4043
214S	H201	0.4145	0.5855	6.4404	4.5596	5.6779	5.6779
214SFFC	0034	0.4104	0.5896	5.8955	4.1045	5.4043	5.4043
215M	0003	0.4109	0.5891	8.8359	6.1641	5.4361	5.4361
215M	H201	0.4148	0.5852	9.3629	6.6371	5.6993	5.6993
215R	0015	0.4171	0.5829	9.9086	7.0914	5.7086	5.7086
215RDS	0013	0.4171	0.5829	9.3257	6.6743	5.7086	5.7086
215S	0024	0.4148	0.5852	6.4370	4.5630	5.6995	5.6995
215S	H201	0.4148	0.5852	6.4370	4.5630	5.6995	5.6995
216M	0004	0.4098	0.5902	8.8531	6.1469	5.3625	5.3625
216R	0018	0.4228	0.5772	9.2354	6.7646	6.1490	6.1490
216RDM	0001	0.4228	0.5772	9.8126	7.1874	6.1490	6.1490
216RDS	0018	0.4228	0.5772	9.8126	7.1874	6.1490	6.1490
216S	0015	0.4134	0.5866	5.8659	4.1341	5.6011	5.6011
216SFFC	0031	0.4134	0.5866	5.8659	4.1341	5.6011	5.6011
216SZZC	0005	0.4134	0.5866	5.8659	4.1341	5.6011	5.6011
217M	0001	0.4189	0.5811	9.8781	7.1219	6.0059	6.0059
217R	0012	0.4213	0.5787	9.8379	7.1621	6.0152	6.0152
217S	0022	0.4122	0.5878	5.8782	4.1218	5.5179	5.5179
218M	H501	0.4111	0.5889	9.4224	6.5776	5.4465	5.4465
218R	0014	0.4133	0.5867	9.3868	6.6132	5.4553	5.4553
218RDM	0001	0.4133	0.5867	8.8001	6.1999	5.4553	5.4553
218RDS	0007	0.4133	0.5867	8.8001	6.1999	5.4553	5.4553
218S	H501	0.4145	0.5855	6.4408	4.5592	5.6752	5.6752
219M	H501	0.4101	0.5899	8.8479	6.1521	5.3847	5.3847
219R	XXXX	0.4182	0.5818	9.8901	7.1099	5.8024	5.8024
219RDM	XXXX	0.4188	0.5812	9.2996	6.7004	5.8434	5.8434
219RDS	H701	0.4195	0.5805	9.2875	6.7125	5.8464	5.8464
219S	H501	0.4101	0.5899	5.8986	4.1014	5.3847	5.3847
220M	H501	0.4093	0.5907	8.8607	6.1393	5.3304	5.3304
220R	0016	0.4169	0.5831	9.9120	7.0880	5.7170	5.7170
220R-BKE	0015	0.4169	0.5831	9.3290	6.6710	5.7170	5.7170
220RDM	XXXX	0.4169	0.5831	9.3290	6.6710	5.7170	5.7170
220S	H501	0.4093	0.5907	5.9071	4.0929	5.3304	5.3304
221M	0002	0.4139	0.5861	9.3776	6.6224	5.6349	5.6349
221R	XXXX	0.4160	0.5840	9.3432	6.6568	5.6434	5.6434
221RDM	XXXX	0.4160	0.5840	9.3432	6.6568	5.6434	5.6434
221S	H501	0.4085	0.5915	5.9148	4.0852	5.2825	5.2825
222M	XXXX	0.4129	0.5871	9.3929	6.6071	5.5693	5.5693
222R	0007	0.4150	0.5850	9.3601	6.6399	5.5774	5.5774
222S	H501	0.4078	0.5922	5.9218	4.0782	5.2400	5.2400
224M	0001	0.4100	0.5900	8.8506	6.1494	5.3732	5.3732
224R	0013	0.4166	0.5834	9.3345	6.6655	5.6987	5.6987
224S	XXXX	0.4147	0.5853	6.4383	4.5617	5.6912	5.6912
226M	0001	0.4162	0.5838	9.3406	6.6594	5.8001	5.8001

MRC Ball Bearing Vibration Data
Data Based on a Speed of 1 RPM

MRC Bearing Services

Values in Cycles per Minute

Bearing Size	Suffix	Inner Rotation	Outer Rotation	Inner or Outer Ring Rotation		Inner Rotation	Outer Rotation
		Cage Speed Frequency (RPM)	Cage Speed Frequency (RPM)	Inner Ring Frequency	Outer Ring Frequency	Rolling Element Frequency	Rolling Element Frequency
226R	0008	0.4183	0.5817	9.8883	7.1117	5.8085	5.8085
226RDM	XXXX	0.4183	0.5817	9.8883	7.1117	5.8085	5.8085
228R	0006	0.4205	0.5795	9.8507	7.1493	5.9867	5.9867
230R	0003	0.4189	0.5811	9.8789	7.1211	5.8546	5.8546
232R	0007	0.4172	0.5828	9.9069	7.0931	5.7437	5.7437
234R	XXXX	0.4160	0.5840	9.3435	6.6565	5.8001	5.8001
236R	0003	0.4194	0.5806	9.8704	7.1296	5.8995	5.8995
238R	0001	0.4213	0.5787	10.4174	7.5826	6.0292	6.0292
240R	XXXX	0.4226	0.5774	10.3925	7.6075	6.1484	6.1484
242R	XXXX	0.4214	0.5786	10.4147	7.5853	6.0412	6.0412
244R	XXXX	0.4201	0.5799	9.8585	7.1415	5.9465	5.9465
246R	XXXX	0.4192	0.5808	9.8738	7.1262	5.8640	5.8640
248R	XXXX	0.4181	0.5819	9.8926	7.1074	5.7895	5.7895
250R	XXXX	0.4174	0.5826	9.9045	7.0955	5.7241	5.7241
252R	XXXX	0.4164	0.5836	9.9205	7.0795	5.6640	5.6640
256R	XXXX	0.4210	0.5790	10.4218	7.5782	5.9884	5.9884
260R	XXXX	0.4232	0.5768	10.3828	7.6172	6.1505	6.1505
264R	XXXX	0.4251	0.5749	10.3478	7.6522	6.2979	6.2979
300S	H501	0.3391	0.6609	3.9656	2.0344	2.7851	2.7851
301R	XXXX	0.3425	0.6575	4.6021	2.3979	2.7806	2.7806
301S	H501	0.3380	0.6620	3.9719	2.0281	2.7628	2.7628
302R	XXXX	0.3786	0.6214	6.2145	3.7855	3.7536	3.7536
302S	H501	0.3608	0.6392	4.4747	2.5253	3.3122	3.3122
303M	XXXX	0.3512	0.6488	5.1906	2.8094	3.0621	3.0621
303R	XXXX	0.3795	0.6205	6.2055	3.7945	3.7973	3.7973
303S	H501	0.3636	0.6364	4.4551	2.5449	3.3918	3.3918
304M	XXXX	0.3677	0.6323	5.6906	3.3094	3.5149	3.5149
304R	0013	0.3712	0.6288	6.2877	3.7123	3.5288	3.5288
304S	H501	0.3677	0.6323	4.4261	2.5739	3.5149	3.5149
304SFFC	H401	0.3677	0.6323	4.4261	2.5739	3.5149	3.5149
304SZCC	H401	0.3677	0.6323	4.4261	2.5739	3.5149	3.5149
305M	0006	0.3723	0.6277	6.2773	3.7227	3.6591	3.6591
305R	0019	0.3934	0.6066	7.2788	4.7212	4.3595	4.3595
305S	0059	0.3723	0.6277	4.3941	2.6059	3.6591	3.6591
305SFFC	0091	0.3723	0.6277	4.3936	2.6064	3.6615	3.6615
305SWI	0011	0.3845	0.6155	4.9239	3.0761	4.0983	4.0983
305SZCC	0012	0.3723	0.6277	4.3936	2.6064	3.6615	3.6615
306M	0009	0.3755	0.6245	6.2451	3.7549	3.7668	3.7668
306R	0020	0.3935	0.6065	7.2775	4.7225	4.3814	4.3814
306S	0104	0.3755	0.6245	4.9961	3.0039	3.7668	3.7668
306S	H201	0.3817	0.6183	4.9465	3.0535	3.9896	3.9896
305S	H501	0.3684	0.6322	4.4254	2.5746	3.5179	3.5179
306SFFC	0092	0.3755	0.6245	4.9961	3.0039	3.7668	3.7668
306SWI	0005	0.3761	0.6239	4.9912	3.0088	3.7878	3.7878
306SZCC	0034	0.3755	0.6245	4.9961	3.0039	3.7668	3.7668
307M	0014	0.3688	0.6312	6.3115	3.6885	3.5501	3.5501
307R	0014	0.3922	0.6078	7.2937	4.7063	4.3171	4.3171
307RDM	XXXX	0.3922	0.6078	7.2937	4.7063	4.3171	4.3171
307S	0091	0.3688	0.6312	4.4181	2.5819	3.5501	3.5501
307S	H201	0.3827	0.6173	4.9388	3.0612	4.0262	4.0262
307SFFC	0094	0.3688	0.6312	4.4181	2.5819	3.5501	3.5501
307SWI	0006	0.3758	0.6242	4.9939	3.0061	3.7761	3.7761
307SZCC	0023	0.3688	0.6312	4.4181	2.5819	3.5501	3.5501
308M	0006	0.3779	0.6221	6.8432	4.1568	3.8503	3.8503
308R	0021	0.3924	0.6076	7.2910	4.7090	4.3389	4.3389
308S	0058	0.3779	0.6221	4.9769	3.0231	3.8503	3.8503
308S	H201	0.3840	0.6160	4.9281	3.0719	4.0777	4.0777
308SFFC	0096	0.3779	0.6221	4.9769	3.0231	3.8503	3.8503
308SZCC	0025	0.3779	0.6221	4.9769	3.0231	3.8503	3.8503
308WI	XXXX	0.3779	0.6221	6.8433	4.1567	3.8502	3.8502
309M	0002	0.3741	0.6259	6.8850	4.1150	3.7192	3.7192
309R	0019	0.3928	0.6072	7.2862	4.7138	4.3572	4.3572
309RDM	XXXX	0.3928	0.6072	7.2862	4.7138	4.3572	4.3572

Values in Cycles per Minute

Bearing Size	Suffix	Inner Rotation	Outer Rotation	Inner or Outer Ring Rotation		Inner Rotation	Outer Rotation
		Cage Speed Frequency (RPM)	Cage Speed Frequency (RPM)	Inner Ring Frequency	Outer Ring Frequency	Rolling Element Frequency	Rolling Element Frequency
309S	0069	0.3741	0.6259	4.3814	2.6186	3.7192	3.7192
309S	H201	0.3796	0.6204	4.9635	3.0365	3.9108	3.9108
309SFFC	0075	0.3741	0.6259	4.3814	2.6186	3.7192	3.7192
309SWI	0005	0.3796	0.6204	4.9635	3.0365	3.9108	3.9108
309SZZC	0021	0.3741	0.6259	4.3814	2.6186	3.7192	3.7192
310M	0004	0.3809	0.6191	6.8097	4.1903	3.9613	3.9613
310R	0015	0.3830	0.6170	7.4038	4.5962	3.9696	3.9696
310RDS	0005	0.3830	0.6170	6.7868	4.2132	3.9696	3.9696
310S	0088	0.3809	0.6191	4.9525	3.0475	3.9613	3.9613
310S	H201	0.3809	0.6191	4.9525	3.0475	3.9613	3.9613
310SFFC	0091	0.3809	0.6191	4.9525	3.0475	3.9613	3.9613
310SWI	0013	0.3809	0.6191	4.9525	3.0475	3.9613	3.9613
310SZZC	0011	0.3809	0.6191	4.9525	3.0475	3.9613	3.9613
311M	0018	0.3775	0.6225	6.8472	4.1528	3.8377	3.8377
311M	H201	0.3821	0.6179	7.4151	4.5849	4.0040	4.0040
311R	0016	0.3844	0.6156	7.3868	4.6132	4.0134	4.0134
311RDM	XXXX	0.3844	0.6156	6.7713	4.2287	4.0134	4.0134
311RDS	H701	0.3844	0.6156	6.7713	4.2287	4.0134	4.0134
311S	0052	0.3821	0.6179	4.9434	3.0566	4.0040	4.0040
311S	H201	0.3821	0.6179	4.9434	3.0566	4.0040	4.0040
311SFFC	0052	0.3821	0.6179	4.9434	3.0566	4.0040	4.0040
311SWI	0003	0.3821	0.6179	4.9434	3.0566	4.0040	4.0040
311SZZC	0027	0.3821	0.6179	4.9434	3.0566	4.0040	4.0040
311WI	0014	0.3791	0.6209	6.8296	4.1704	3.8949	3.8949
312M	0002	0.3830	0.6170	6.7867	4.2133	4.0406	4.0406
312M	H201	0.3830	0.6170	7.4037	4.5963	4.0406	4.0406
312R	0019	0.3852	0.6148	7.3776	4.6224	4.0492	4.0492
312RDM	XXXX	0.3852	0.6148	6.7628	4.2372	4.0492	4.0492
312RDS	0006	0.3852	0.6148	6.7628	4.2372	4.0492	4.0492
312S	0013	0.3830	0.6170	4.9358	3.0642	4.0406	4.0406
312S	H201	0.3830	0.6170	4.9358	3.0642	4.0406	4.0406
312SFFC	0046	0.3830	0.6170	4.9358	3.0642	4.0406	4.0406
312SZZC	0017	0.3830	0.6170	4.9358	3.0642	4.0406	4.0406
312WI	XXXX	0.3801	0.6199	6.8186	4.1814	3.9315	3.9315
313M	0002	0.3838	0.6162	7.3939	4.6061	4.0722	4.0722
313M	H201	0.3838	0.6162	7.3939	4.6061	4.0722	4.0722
313R	0012	0.3936	0.6064	8.4896	5.5104	4.4032	4.4032
313RDM	0001	0.3936	0.6064	7.2768	4.7232	4.4032	4.4032
313RDU	H701	0.3936	0.6064	7.2768	4.7232	4.4032	4.4032
313S	0030	0.3838	0.6162	4.9293	3.0707	4.0722	4.0722
313S	H201	0.3838	0.6162	4.9293	3.0707	4.0732	4.0732
313SFFC	0057	0.3838	0.6162	4.9293	3.0707	4.0732	4.0732
313SWI	0003	0.3816	0.6184	4.9470	3.0530	3.9873	3.9873
314M	0001	0.3845	0.6155	7.3855	4.6145	4.0998	4.0998
314M	H201	0.3845	0.6155	7.3855	4.6145	4.0998	4.0998
314R	0012	0.3939	0.6061	7.2729	4.7271	4.4115	4.4115
314S	0022	0.3845	0.6155	4.9236	3.0764	4.0998	4.0998
314S	H201	0.3845	0.6155	4.9236	3.0764	4.0998	4.0998
314SFFC	0052	0.3845	0.6155	4.9236	3.0764	4.0998	4.0998
314WI	XXXX	0.3846	0.6154	7.3854	4.6146	4.1000	4.1000
315M	H501	0.3852	0.6148	7.3781	4.6219	4.1242	4.1242
315R	0024	0.3939	0.6061	8.4848	5.5152	4.4179	4.4179
315R-BKE	0025	0.3939	0.6061	7.8788	5.1212	4.4179	4.4179
315RDM	0003	0.3939	0.6061	7.8788	5.1212	4.4179	4.4179
315S	H501	0.3852	0.6148	4.9187	3.0813	4.1242	4.1242
315SWI	0005	0.3787	0.6213	4.9707	3.0293	3.8782	3.8782
315SZZC	0013	0.3784	0.6216	4.9728	3.0272	3.8688	3.8688
315WI	XXXX	0.3854	0.6146	7.3751	4.6249	4.1341	4.1341
316M	H501	0.3857	0.6143	7.3716	4.6284	4.1459	4.1459
316R	0009	0.3940	0.6060	7.8786	5.1214	4.4235	4.4235
316RDM	0001	0.3940	0.6060	7.8786	5.1214	4.4235	4.4235
316S	H501	0.3857	0.6143	4.9144	3.0856	4.1459	4.1459

***MRC Ball Bearing Vibration Data
Data Based on a Speed of 1 RPM***

MRC Bearing Services

Values in Cycles per Minute

Bearing Size	Suffix	Inner Rotation	Outer Rotation	Inner or Outer Ring Rotation		Inner Rotation	Outer Rotation
		Cage Speed Frequency (RPM)	Cage Speed Frequency (RPM)	Inner Ring Frequency	Outer Ring Frequency	Rolling Element Frequency	Rolling Element Frequency
316SZC	0015	0.3794	0.6206	4.9652	3.0348	3.9030	3.9030
316WI	XXXX	0.3921	0.6079	7.9033	5.0967	4.4162	4.4162
317M	H501	0.3862	0.6138	7.3659	4.6341	4.1652	4.1652
317R	0007	0.3943	0.6057	8.4803	5.5197	4.4295	4.4295
317RDU	H701	0.3943	0.6057	7.8746	5.1254	4.4295	4.4295
317S	H501	0.3862	0.6138	4.9106	3.0894	4.1652	4.1652
318M	H501	0.3866	0.6134	7.3607	4.6393	4.1827	4.1827
318R	0011	0.3943	0.6057	7.8746	5.1254	4.4339	4.4339
318RDM	0003	0.3943	0.6057	7.8746	5.1254	4.4339	4.4339
318S	H501	0.3866	0.6134	4.9071	3.0929	4.1827	4.1827
318SFFC	H501	0.3866	0.6134	4.9071	3.0929	4.1827	4.1827
318SWI	H501	0.3923	0.6077	4.8618	3.1382	4.4261	4.4261
318WI	XXXX	0.3866	0.6134	7.3607	4.6393	4.1827	4.1827
319M	0001	0.3924	0.6076	7.8991	5.1009	4.4304	4.4304
319R	0014	0.3943	0.6057	7.8747	5.1253	4.4379	4.4379
319S	H501	0.3870	0.6130	4.9041	3.0959	4.1984	4.1984
320M	0001	0.3841	0.6159	7.3909	4.6091	4.0818	4.0818
320R	XXXX	0.3959	0.6041	7.8529	5.1471	4.5198	4.5198
320RDM	0001	0.3959	0.6041	7.8529	5.1471	4.5198	4.5198
320S	XXXX	0.3790	0.6210	4.9676	3.0324	3.8920	3.8920
320SWI	H501	0.3790	0.6210	4.9676	3.0324	3.8920	3.8920
321M	0001	0.3845	0.6155	7.3854	4.6146	4.0998	4.0998
321R	0006	0.3961	0.6039	7.8508	5.1492	4.5204	4.5204
321RDM	XXXX	0.3961	0.6039	7.8508	5.1492	4.5204	4.5204
321S	XXXX	0.3845	0.6155	4.9236	3.0764	4.0998	4.0998
322M	0001	0.3866	0.6134	7.3607	4.6393	4.1827	4.1827
322R	0004	0.3930	0.6070	7.8915	5.1085	4.3827	4.3827
322RDM	XXXX	0.3930	0.6070	7.8915	5.1085	4.3827	4.3827
322S	XXXX	0.3821	0.6179	4.9434	3.0566	4.0040	4.0040
323S	XXXX	0.3994	0.6006	5.4057	3.5943	4.7670	4.7670
324R	0010	0.3930	0.6070	7.8903	5.1097	4.3927	4.3927
324RDM	XXXX	0.3930	0.6070	7.8903	5.1097	4.3927	4.3927
326R	XXXX	0.3934	0.6066	7.8852	5.1148	4.4025	4.4025
326RDM	XXXX	0.3934	0.6066	7.8852	5.1148	4.4025	4.4025
328R	XXXX	0.3935	0.6065	7.8852	5.1148	4.4025	4.4025
328RDM	XXXX	0.3935	0.6065	7.8852	5.1148	4.4025	4.4025
330R	XXXX	0.3971	0.6029	8.4404	5.5596	4.5730	4.5730
330RDM	XXXX	0.3971	0.6029	8.4404	5.5596	4.5730	4.5730
332R	XXXX	0.3969	0.6031	8.4404	5.5572	4.5694	4.5694
332RDM	XXXX	0.3969	0.6031	8.4404	5.5572	4.5694	4.5694
334R	XXXX	0.4000	0.6000	8.4002	5.5998	4.7133	4.7133
336R	XXXX	0.3997	0.6003	8.4046	5.5954	4.7021	4.7021
338R	XXXX	0.3997	0.6003	8.4046	5.5954	4.7021	4.7021
34	H001	0.3449	0.6551	3.9303	2.0697	2.8511	2.8511
340R	XXXX	0.3994	0.6006	8.4084	5.5916	4.6842	4.6842
342R	XXXX	0.3992	0.6008	8.4118	5.5882	4.6761	4.6761
344R	XXXX	0.3991	0.6009	8.4118	5.5882	4.6761	4.6761
348R	XXXX	0.4033	0.5967	8.3542	5.6458	4.8771	4.8771
35	XXXX	0.3449	0.6551	3.9303	2.0697	2.8511	2.8511
352R	XXXX	0.4068	0.5932	8.8975	6.1025	5.0671	5.0671
356R	XXXX	0.4062	0.5938	8.9069	6.0931	5.0257	5.0257
36	H401	0.3440	0.6560	3.9362	2.0638	2.8418	2.8418
37	H503	0.3697	0.6303	4.4123	2.5877	3.4045	3.4045
37	H501	0.3664	0.6336	4.4352	2.5648	3.3918	3.3918
38	H501	0.3682	0.6318	4.4226	2.5774	3.4452	3.4452
38	H503	0.3682	0.6318	4.4266	2.5774	3.4452	3.4452
38ZZC	0016	0.3656	0.6344	4.4410	2.5590	3.4507	3.4507
39	H502	0.3689	0.6311	4.4177	2.5823	3.4806	3.4806
403M	XXXX	0.3392	0.6608	5.2861	2.7139	2.7887	2.7887
403R	XXXX	0.3417	0.6583	5.2666	2.7334	2.7984	2.7984
403S	H501	0.3392	0.6608	3.9646	2.0354	2.7887	2.7887
404M	0001	0.3447	0.6553	5.2424	2.7576	2.9090	2.9090

Values in Cycles per Minute

Bearing Size	Suffix	Inner Rotation	Outer Rotation	Inner or Outer Ring Rotation		Inner Rotation	Outer Rotation
		Cage Speed Frequency (RPM)	Cage Speed Frequency (RPM)	Inner Ring Frequency	Outer Ring Frequency	Rolling Element Frequency	Rolling Element Frequency
404R	XXXX	0.3471	0.6529	5.8765	3.1235	2.9183	2.9183
404S	H501	0.3361	0.6639	3.9837	2.0163	2.7220	2.7220
405M	0002	0.3488	0.6512	5.2095	2.7905	3.0048	3.0048
405R	XXXX	0.3511	0.6489	5.8400	3.1600	3.0139	3.0139
405S	H501	0.3608	0.6392	4.4746	2.5254	3.3128	3.3128
406M	0C01	0.3779	0.6221	6.8432	4.1568	3.8503	3.8503
406R	0009	0.3566	0.6434	6.4341	3.5659	3.1533	3.1533
406S	H501	0.3611	0.6389	4.4724	2.5276	3.3214	3.3214
407M	0001	0.3741	0.6259	6.8850	4.1150	3.7192	3.7192
407R	0014	0.3611	0.6389	6.3888	3.6112	3.2700	3.2700
407S	H501	0.3609	0.6391	4.4734	2.5266	3.3173	3.3173
408M	0001	0.3624	0.6376	6.3758	3.6242	3.3591	3.3591
408R	0011	0.3644	0.6356	6.3557	3.6443	3.3670	3.3670
408S	H501	0.3624	0.6376	4.4631	2.5369	3.3591	3.3591
409M	0001	0.3653	0.6347	6.3469	3.6531	3.4427	3.4427
409R	XXXX	0.3674	0.6326	6.3265	3.6735	3.4508	3.4508
409S	H501	0.3605	0.6395	4.4766	2.5234	3.3049	3.3049
410M	0001	0.3677	0.6323	6.3229	3.6771	3.5149	3.5149
410R	XXXX	0.3697	0.6303	6.9331	4.0669	3.5229	3.5229
410S	XXXX	0.3589	0.6411	4.4878	2.5122	3.2611	3.2611
411M	0002	0.3697	0.6303	6.3026	3.6974	3.5781	3.5781
411R	XXXX	0.3717	0.6283	6.9110	4.0890	3.5859	3.5859
411S	H501	0.3616	0.6384	4.4688	2.5312	3.3360	3.3360
412M	0001	0.3715	0.6285	6.9136	4.0864	3.6337	3.6337
412R	XXXX	0.3734	0.6266	6.8921	4.1079	3.6415	3.6415
412S	H501	0.3639	0.6361	4.4525	2.5475	3.4024	3.4024
413M	0001	0.3784	0.6216	6.8375	4.1625	3.8688	3.8688
413R	0015	0.3748	0.6252	6.8768	4.1232	3.6904	3.6904
413S	H501	0.3659	0.6341	4.4384	2.5616	3.4617	3.4617
414M	0001	0.3794	0.6206	7.4478	4.5522	3.9030	3.9030
414R	XXXX	0.3687	0.6313	6.9446	4.0554	3.4909	3.4909
414S	H501	0.3603	0.6397	4.4779	2.5221	3.2997	3.2997
415M	0001	0.3862	0.6138	7.3658	4.6342	4.1653	4.1653
415R	XXXX	0.3702	0.6298	6.9277	4.0723	3.5383	3.5383
415S	H501	0.3622	0.6378	4.4645	2.5355	3.3534	3.3534
416M	0001	0.3809	0.6191	7.4288	4.5712	3.9613	3.9613
416R	XXXX	0.3716	0.6284	6.9126	4.0874	3.5814	3.5814
416S	H501	0.3639	0.6361	4.4525	2.5475	3.4024	3.4024
417M	0001	0.3816	0.6184	7.4207	4.5793	3.9866	3.9866
417R	XXXX	0.3728	0.6272	6.8991	4.1009	3.6209	3.6209
417S	H502	0.3655	0.6345	4.4417	2.5583	3.4475	3.4475
418M	0001	0.3790	0.6210	7.4514	4.5486	3.8920	3.8920
418R	XXXX	0.3710	0.6290	6.9194	4.0806	3.5617	3.5617
418S	XXXX	0.3639	0.6361	4.4525	2.5475	3.4024	3.4024
419M	XXXX	0.3666	0.6334	6.3344	3.6656	3.4801	3.4801
419R	XXXX	0.3731	0.6269	6.8957	4.1043	3.6309	3.6309
419S	XXXX	0.3712	0.6288	4.4019	2.5981	3.6231	3.6231
420M	XXXX	0.3652	0.6348	6.3483	3.6517	3.4388	3.4388
420R	XXXX	0.3715	0.6285	6.9135	4.0865	3.5790	3.5790
420S	XXXX	0.3695	0.6305	4.4133	2.5867	3.5711	3.5711
421R	XXXX	0.3654	0.6346	6.3457	3.6543	3.3941	3.3941
421S	XXXX	0.3714	0.6286	4.4003	2.5997	3.6306	3.6306
422R	XXXX	0.3655	0.6345	6.3452	3.6548	3.3954	3.3954
422S	XXXX	0.3745	0.6255	4.3787	2.6213	3.7323	3.7323
5200SB	H301	0.3969	0.6031	4.2218	2.7782	4.0209	4.0209
5200SB	H501	0.3881	0.6119	4.8951	3.1049	3.9892	3.9892
5201SB	H301	0.3906	0.6094	4.2657	2.7343	3.7689	3.7689
5201SB	H501	0.3873	0.6127	4.9014	3.0986	3.8177	3.8177
5202SB	H501	0.3849	0.6151	4.3057	2.6943	3.7286	3.7286
5202SB	H301	0.4037	0.5963	4.7700	3.2300	4.3319	4.3319
5203SB	H501	0.3966	0.6034	4.8268	3.1732	4.1975	4.1975
5204C	H501	0.3956	0.6044	4.8349	3.1651	3.9684	3.9684

MRC Ball Bearing Vibration Data
Data Based on a Speed of 1 RPM

MRC Bearing Services

Values in Cycles per Minute

Bearing Size	Suffix	Inner Rotation	Outer Rotation	Inner or Outer Ring Rotation		Inner Rotation	Outer Rotation
		Cage Speed Frequency (RPM)	Cage Speed Frequency (RPM)	Inner Ring Frequency	Outer Ring Frequency	Rolling Element Frequency	Rolling Element Frequency
5204M	H501	0.3956	0.6044	6.6480	4.3520	3.9684	3.9684
5205C	H501	0.4088	0.5912	5.3207	3.6793	4.5905	4.5905
5205M	H501	0.4088	0.5912	7.6855	5.3145	4.5905	4.5905
5206C	H501	0.4103	0.5897	5.3070	3.6930	4.6740	4.6740
5206M	H501	0.4103	0.5897	7.0760	4.9240	4.6740	4.6740
5207C	H501	0.4083	0.5917	5.3251	3.6749	4.5642	4.5642
5207M	H501	0.4083	0.5917	7.1002	4.8998	4.5642	4.5642
5208C	H501	0.4093	0.5907	5.3164	3.6836	4.6162	4.6162
5208M	H501	0.4093	0.5907	7.6793	5.3207	4.6162	4.6162
5209C	H501	0.4180	0.5820	5.8196	4.1804	5.1411	5.1411
5209M	H501	0.4180	0.5820	8.1475	5.8525	5.1411	5.1411
5210C	H501	0.4226	0.5774	5.7738	4.2262	5.4620	5.4620
5210M	H501	0.4226	0.5774	8.6607	6.3393	5.4620	5.4620
5211C	H501	0.4225	0.5775	5.7751	4.2249	5.4524	5.4524
5211M	H501	0.4225	0.5775	9.2401	6.7599	5.4524	5.4524
5212C	H501	0.4208	0.5792	5.7920	4.2080	5.3300	5.3300
5212M	H501	0.4208	0.5792	8.6880	6.3120	5.3300	5.3300
5213C	H501	0.4265	0.5735	6.3086	4.6914	5.7636	5.7636
5213M	H501	0.4265	0.5735	9.1761	6.8239	5.7636	5.7636
5214C	H501	0.4260	0.5740	6.3144	4.6856	5.7206	5.7206
5214M	H501	0.4260	0.5740	9.7586	7.2414	5.7206	5.7206
5215C	H501	0.4255	0.5745	6.3196	4.6804	5.6826	5.6826
5215M	H501	0.4255	0.5745	9.7666	7.2334	5.6826	5.6826
5216C	H501	0.4239	0.5761	5.7608	4.2392	5.5596	5.5596
5216M	H501	0.4239	0.5761	9.7934	7.2066	5.5596	5.5596
5217C	H501	0.4227	0.5773	5.7732	4.2268	5.4663	5.4663
5217M	H501	0.4227	0.5773	9.2371	6.7629	5.4663	5.4663
5218C	H501	0.4249	0.5751	5.7514	4.2486	5.6330	5.6330
5218M	H501	0.4249	0.5751	9.2022	6.7978	5.6330	5.6330
5220	H501	0.4250	0.5750	9.1993	6.8007	5.6470	5.6470
5222	H501	0.4232	0.5768	9.2282	6.7718	5.5082	5.5082
5300SB	H501	0.3832	0.6168	4.9344	3.0656	3.8034	3.8034
5302SB	H502	0.3967	0.6033	4.8265	3.1735	4.1991	4.1991
5303SB	H501	0.3910	0.6090	4.8717	3.1283	3.9612	3.9612
5304C	H501	0.3966	0.6034	4.8267	3.1733	4.0112	4.0112
5304M	H501	0.3966	0.6034	6.6480	4.3520	3.9684	3.9684
5305C	H501	0.3973	0.6027	4.8218	3.1782	4.0372	4.0372
5305M	H501	0.3973	0.6027	7.2327	4.7673	4.0372	4.0372
5306C	H501	0.3962	0.6038	4.8301	3.1699	3.9935	3.9935
5306M	H501	0.3962	0.6038	7.2451	4.7549	3.9935	3.9935
5307C	H501	0.3961	0.6039	4.8314	3.1686	3.9868	3.9868
5307M	H501	0.3961	0.6039	6.6431	4.3569	3.9868	3.9868
5308C	H501	0.3963	0.6037	4.8298	3.1702	3.9952	3.9952
5308M	H501	0.3963	0.6037	7.2446	4.7554	3.9952	3.9952
5309C	H501	0.3968	0.6032	4.8254	3.1746	4.0182	4.0182
5309M	H501	0.3968	0.6032	7.2381	4.7619	4.0182	4.0182
5310C	H501	0.3980	0.6020	4.8161	3.1839	4.0682	4.0682
5310M	H501	0.3980	0.6020	7.2241	4.7759	4.0682	4.0682
5311C	H501	0.3964	0.6036	4.8291	3.1709	3.9988	3.9988
5311M	H501	0.3964	0.6036	7.2436	4.7564	3.9988	3.9988
5312C	H501	0.3970	0.6030	4.8242	3.1758	4.0246	4.0246
5312M	H501	0.3970	0.6030	7.2363	4.7637	4.0246	4.0246
5313C	H501	0.3979	0.6021	4.8169	3.1831	4.0636	4.0636
5313M	H501	0.3979	0.6021	7.2254	4.7746	4.0636	4.0636
5314C	H501	0.3992	0.6008	4.8065	3.1935	4.1208	4.1208
5314M	H501	0.3992	0.6008	7.2097	4.7903	4.1208	4.1208
5315C	H501	0.3974	0.6026	4.8203	3.1797	4.0455	4.0455
5315M	H501	0.3974	0.6026	7.2304	4.7696	4.0455	4.0455
5316M	H501	0.4002	0.5998	7.1978	4.8022	4.1652	4.1652
5317	H501	0.4014	0.5986	7.1828	4.8172	4.2222	4.2222
5318	H501	0.4018	0.5982	7.1784	4.8216	4.2394	4.2394
5319	H501	0.4068	0.5932	7.7117	5.2883	4.4842	4.4842

Values in Cycles per Minute

Bearing Size	Suffix	Inner Rotation	Outer Rotation	Inner or Outer Ring Rotation		Inner Rotation	Outer Rotation
		Cage Speed Frequency (RPM)	Cage Speed Frequency (RPM)	Inner Ring Frequency	Outer Ring Frequency	Rolling Element Frequency	Rolling Element Frequency
5320	H501	0.3996	0.6004	7.2046	4.7954	4.1397	4.1397
5321	H501	0.4000	0.6000	7.1998	4.8002	4.1576	4.1576
5322	H501	0.4018	0.5982	7.1784	4.8216	4.2394	4.2394
5406C	H501	0.3748	0.6252	4.3767	2.6233	3.4184	3.4184
5407C	H501	0.3711	0.6289	3.7735	2.2265	3.3078	3.3078
5408C	H501	0.3743	0.6257	3.7541	2.2459	3.4046	3.4046
5409C	H501	0.3776	0.6225	4.3572	2.6428	3.5063	3.5063
5410C	H502	0.3722	0.6278	4.3946	2.6054	3.3405	3.3405
5411C	H501	0.3810	0.6190	4.3329	2.6671	3.6212	3.6212
5412C	H501	0.3826	0.6174	4.3218	2.6782	3.6762	3.6762
5413C	H501	0.3722	0.6278	4.3943	2.6057	3.3417	3.3417
5414C	H502	0.3840	0.6160	4.3121	2.6879	3.7251	3.7251
5415C	H501	0.3742	0.6258	4.3806	2.6194	3.7229	3.7229
5416C	H501	0.3753	0.6247	4.3731	2.6269	3.7591	3.7591
5417C	H501	0.3709	0.6292	4.4041	2.5960	3.6130	3.6130
5418C	H501	0.3690	0.6310	4.4172	2.5828	3.5538	3.5538
7100KR	XXXX	0.3843	0.6157	4.9256	3.0744	3.5773	3.5773
7101KR	XXXX	0.3959	0.6041	5.4372	3.5628	4.0173	4.0173
7102KR	XXXX	0.4114	0.5886	5.8862	4.1138	4.7794	4.7794
7103KR	XXXX	0.4065	0.5935	6.5281	4.4719	4.5152	4.5152
7104KR	XXXX	0.4104	0.5896	6.4853	4.5147	4.7253	4.7253
7105KR	XXXX	0.4229	0.5771	7.5027	5.4973	5.5347	5.5347
7106KR	XXXX	0.4265	0.5735	8.0292	5.9708	5.8199	5.8199
7107KR	XXXX	0.4284	0.5716	8.0020	5.9980	5.9852	5.9852
7108KR	XXXX	0.4357	0.5643	8.4642	6.5358	6.6908	6.6908
7109KR	XXXX	0.4363	0.5637	9.0183	6.9817	6.7598	6.7598
7110KR	XXXX	0.4412	0.5588	9.4987	7.5013	7.3408	7.3408
7111KR	XXXX	0.4377	0.5623	9.5582	7.4418	6.9165	6.9165
7112KR	XXXX	0.4418	0.5582	10.0482	7.9518	7.4079	7.4079
7113KR	XXXX	0.4453	0.5547	10.5393	8.4607	7.8987	7.8987
7114KR	XXXX	0.4460	0.5540	11.0799	8.9201	8.0045	8.0045
7115KR	XXXX	0.4488	0.5512	11.5742	9.4258	8.4595	8.4595
7116KR	XXXX	0.4458	0.5542	11.6378	9.3622	7.9762	7.9762
7117KR	XXXX	0.4483	0.5517	12.1366	9.8634	8.3742	8.3742
7118KR	XXXX	0.4457	0.5543	11.6409	9.3591	7.9540	7.9540
7119KR	XXXX	0.4421	0.5579	11.1570	8.8430	7.4580	7.4580
7120	XXXX	0.4410	0.5590	11.1794	8.8206	7.3127	7.3127
7120KR	XXXX	0.4500	0.5500	12.6496	10.3504	8.6615	8.6615
7121KR	XXXX	0.4476	0.5524	12.1527	9.8473	8.2549	8.2549
7122	XXXX	0.4413	0.5587	11.7323	9.2677	7.3495	7.3495
7122KR	XXXX	0.4454	0.5546	11.6455	9.3545	7.9217	7.9217
7124	XXXX	0.4418	0.5582	11.7227	9.2773	7.4088	7.4088
7124KR	XXXX	0.4491	0.5509	12.1200	9.8800	8.5008	8.5008
7126	XXXX	0.4461	0.5539	12.1854	9.8146	8.0221	8.0221
7126KR	XXXX	0.4453	0.5547	12.2033	9.7967	7.8995	7.8995
7128	XXXX	0.4458	0.5542	12.1926	9.8074	7.9721	7.9721
7128KR	XXXX	0.4484	0.5516	12.1346	9.8654	8.3895	8.3895
7130	XXXX	0.4457	0.5543	12.1947	9.8053	7.9577	7.9577
7130KR	XXXX	0.4482	0.5518	12.1404	9.8596	8.3458	8.3458
7132	XXXX	0.4458	0.5542	12.1920	9.8080	7.9761	7.9761
7132KR	XXXX	0.4479	0.5521	12.1455	9.8545	8.3079	8.3079
7134	XXXX	0.4457	0.5543	12.1938	9.8062	7.9644	7.9644
7134KR	XXXX	0.4451	0.5549	11.6527	9.3473	7.8707	7.8707
7136	XXXX	0.4457	0.5543	12.1953	9.8047	7.9539	7.9539
7136KR	XXXX	0.4457	0.5543	12.1953	9.8047	7.9539	7.9539
7138	XXXX	0.4433	0.5567	12.2468	9.7532	7.6174	7.6174
7138KR	XXXX	0.4479	0.5521	12.6975	10.3025	8.3079	8.3079
7140	XXXX	0.4439	0.5561	12.2336	9.7664	7.7009	7.7009
7140KR	XXXX	0.4455	0.5545	12.1979	9.8021	7.9363	7.9363
7142	XXXX	0.4419	0.5581	11.7193	9.2807	7.4301	7.4301
7144	XXXX	0.4440	0.5560	12.2326	9.7674	7.7076	7.7076
7144KR	XXXX	0.4405	0.5595	11.7496	9.2504	7.2450	7.2450
7146	XXXX	0.4445	0.5555	12.2218	9.7782	7.7769	7.7769
7148	XXXX	0.4449	0.5551	12.2121	9.7879	7.8406	7.8406
7148KR	XXXX	0.4445	0.5555	12.2218	9.7782	7.7769	7.7769
7152	XXXX	0.4457	0.5543	12.1953	9.8047	7.9540	7.9540
7152KR	XXXX	0.4411	0.5589	11.7370	9.2630	7.3210	7.3210
7156	XXXX	0.4456	0.5544	12.1971	9.8029	7.9417	7.9417
7156KR	XXXX	0.4445	0.5555	12.2218	9.7782	7.7769	7.7769
7160KR	XXXX	0.4415	0.5585	11.7277	9.2723	7.3780	7.3780
7164	XXXX	0.4458	0.5542	12.1920	9.8080	7.9761	7.9761
7164KR	XXXX	0.4445	0.5555	12.2218	9.7782	7.7769	7.7769
7200P	XXXX	0.3784	0.6216	4.9729	3.0271	2.9633	2.9633
7200S	0003	0.3741	0.6259	4.3814	2.6186	3.3705	3.3705
7201P	XXXX	0.3894	0.6106	5.4950	3.5050	3.2950	3.2950

MRC Ball Bearing Vibration Data
Data Based on a Speed of 1 RPM

MRC Bearing Services

Values in Cycles per Minute

Bearing Size	Suffix	Inner Rotation	Outer Rotation	Inner or Outer Ring Rotation		Inner Rotation	Outer Rotation
		Cage Speed Frequency (RPM)	Cage Speed Frequency (RPM)	Inner Ring Frequency	Outer Ring Frequency	Rolling Element Frequency	Rolling Element Frequency
7201S	0001	0.3705	0.6295	4.4063	2.5937	3.2653	3.2653
7202	H401	0.3855	0.6145	6.1449	3.8551	3.7505	3.7505
7202P	XXXX	0.3905	0.6095	4.8757	3.1243	3.3314	3.3314
7203	H401	0.3858	0.6142	6.1419	3.8581	3.7614	3.7614
7203P	XXXX	0.3933	0.6067	5.4600	3.5400	3.4273	3.4273
7204	0001	0.4038	0.5962	6.5578	4.4422	4.5381	4.5381
7204-BKE	XXXX	0.4038	0.5962	6.5578	4.4422	4.5381	4.5381
7204P	XXXX	0.4001	0.5999	5.9984	4.0016	3.6833	3.6833
7205	H501	0.4079	0.5921	7.1051	4.8949	4.5874	4.5874
7205DU	0004	0.4079	0.5921	6.5130	4.4870	4.5874	4.5874
7205P	XXXX	0.4131	0.5869	7.0425	4.9575	4.2759	4.2759
7205P-BKE	XXXX	0.4131	0.5869	6.4553	4.5447	4.2772	4.2772
7205PJ	H501	0.4210	0.5790	8.1055	5.8945	4.7296	4.7296
7206	0C01	0.4249	0.5751	8.0512	5.9488	5.6930	5.6930
7206	0001	0.4249	0.5751	8.0512	5.9488	5.6930	5.6930
7206P	XXXX	0.4140	0.5860	6.4452	4.5548	4.3256	4.3256
7206PJ	H501	0.4140	0.5860	7.6171	5.3829	4.3256	4.3256
7207	0001	0.4225	0.5775	8.0846	5.9154	5.5093	5.5093
7207P	XXXX	0.4147	0.5853	7.0230	4.9770	4.3624	4.3624
7207PJ	H501	0.4147	0.5853	7.6082	5.3918	4.3624	4.3624
7208	0C01	0.4190	0.5810	8.1339	5.8661	5.2576	5.2576
7208P	XXXX	0.4189	0.5811	6.9729	5.0271	4.6002	4.6002
7208PJ	H501	0.4194	0.5806	8.1275	5.8725	4.6324	4.6324
7209	0C01	0.4252	0.5748	8.0467	5.9533	5.7186	5.7186
7209-BKE	XXXX	0.4252	0.5748	8.6214	6.3786	5.7186	5.7186
7209P	XXXX	0.4205	0.5795	7.5338	5.4662	4.6948	4.6948
7209PJ	H501	0.4251	0.5749	8.6225	6.3775	5.0035	5.0035
7210	0001	0.4309	0.5691	9.1052	6.8948	6.2099	6.2099
7210P	XXXX	0.4261	0.5739	8.0338	5.9662	5.0740	5.0740
7210PJ	H501	0.4305	0.5695	9.1119	6.8881	5.4053	5.4053
7211	0001	0.4183	0.5817	8.1441	5.8559	5.2082	5.2082
7211P	XXXX	0.4254	0.5746	8.0434	5.9566	5.0251	5.0251
7211PJ	H501	0.4294	0.5706	9.1297	6.8703	5.3165	5.3165
7212	0001	0.4268	0.5732	9.1703	6.8297	5.8511	5.8511
7212P	XXXX	0.4249	0.5751	8.0516	5.9484	4.9840	4.9840
7212PJ	H501	0.4274	0.5726	8.5885	6.4115	5.1672	5.1672
7213	0001	0.4249	0.5751	9.2008	6.7992	5.6954	5.6954
7213-BKE	XXXX	0.4249	0.5751	8.6258	6.3742	5.6954	5.6954
7213DB	H701	0.3977	0.6023	6.6254	4.3746	4.0954	4.0954
7213P	XXXX	0.4277	0.5723	8.0123	5.9877	5.1864	5.1864
7213PJ	H501	0.4277	0.5723	8.5846	6.4154	5.1864	5.1864
7214	0004	0.4291	0.5709	9.1336	6.8664	6.0485	6.0485
7214P	XXXX	0.4283	0.5717	8.0041	5.9959	5.2304	5.2304
7214PJ	H501	0.4305	0.5695	9.1124	6.8876	5.4024	5.4024
7215	0001	0.4255	0.5745	9.7666	7.2334	5.7393	5.7393
7215-BKE	XXXX	0.4255	0.5745	9.1921	6.8079	5.7393	5.7393
7215P	XXXX	0.4318	0.5682	8.5234	6.4766	5.5097	5.5097
7215PJ	H501	0.4338	0.5662	9.6243	7.3757	5.6902	5.6902
7216	0001	0.4306	0.5694	9.1108	6.8892	6.1778	6.1778
7216-BKE	XXXX	0.4306	0.5694	9.6802	7.3198	6.1778	6.1778
7216P	XXXX	0.4336	0.5664	9.0613	6.9387	5.6726	5.6726
7216PJ	H501	0.4336	0.5664	9.6277	7.3723	5.6726	5.6726
7217	0001	0.4291	0.5709	9.7053	7.2947	6.0440	6.0440
7217P	XXXX	0.4301	0.5699	8.5480	6.4520	5.3753	5.3753
7217PJ	H501	0.4315	0.5685	9.0953	6.9047	5.4902	5.4902
7218	0001	0.4222	0.5778	9.2441	6.7559	5.4882	5.4882
7218DT	0001	0.4222	0.5778	8.6663	6.3337	5.4882	5.4882
7218P	XXXX	0.4294	0.5706	8.5581	6.4419	5.3220	5.3220
7218PJ	H501	0.4310	0.5690	9.1031	6.8969	5.4501	5.4501
7219	0001	0.4266	0.5734	9.7470	7.2530	5.8334	5.8334
7219-BKE	XXXX	0.4266	0.5734	9.1736	6.8264	5.8334	5.8334
7219P	XXXX	0.4306	0.5694	9.1101	6.8899	5.4144	5.4144

Values in Cycles per Minute

Bearing Size	Suffix	Inner Rotation	Outer Rotation	Inner or Outer Ring Rotation		Inner Rotation	Outer Rotation
		Cage Speed Frequency (RPM)	Cage Speed Frequency (RPM)	Inner Ring Frequency	Outer Ring Frequency	Rolling Element Frequency	Rolling Element Frequency
7220	0001	0.4260	0.5740	9.7582	7.2418	5.7792	5.7792
7220-BKE	XXXX	0.4214	0.5786	9.2575	6.7425	5.4268	5.4268
7220P	XXXX	0.4305	0.5695	9.1119	6.8881	5.4053	5.4053
7221	0003	0.4251	0.5749	9.1989	6.8011	5.7050	5.7050
7221P	XXXX	0.4299	0.5701	8.5512	6.4488	5.3581	5.3581
7222	0002	0.4238	0.5762	9.2183	6.7817	5.6102	5.6102
7222P	XXXX	0.4294	0.5706	8.5592	6.4408	5.3162	5.3162
7224	0002	0.4250	0.5750	9.1991	5.8009	5.7042	5.7042
7224P	XXXX	0.4311	0.5689	8.5331	6.4669	5.4557	5.4557
7226	0001	0.4268	0.5732	9.7436	7.2564	5.8499	5.8499
7226P	XXXX	0.4325	0.5675	9.0795	6.9205	5.5738	5.5738
7228	XXXX	0.4284	0.5716	9.7163	7.2837	5.9873	5.9873
7228P	XXXX	0.4345	0.5655	9.0477	6.9523	5.7490	5.7490
7230	XXXX	0.4273	0.5727	9.7364	7.2636	5.8857	5.8857
7230P	XXXX	0.4334	0.5666	9.0655	6.9345	5.6494	5.6494
7232	XXXX	0.4259	0.5741	9.7589	7.2411	5.7760	5.7760
7232P	XXXX	0.4351	0.5649	9.0377	6.9623	5.8062	5.8062
7234	XXXX	0.4248	0.5752	9.2033	6.7967	5.6831	5.6831
7234P	XXXX	0.4341	0.5659	9.0540	6.9460	5.7137	5.7137
7236	XXXX	0.4278	0.5722	9.7274	7.2726	5.9306	5.9306
7236P	XXXX	0.4367	0.5633	9.5750	7.4250	5.9600	5.9600
7238	XXXX	0.4293	0.5707	10.2732	7.7268	6.0588	6.0588
7238P	XXXX	0.4380	0.5620	10.1151	7.8849	6.0877	6.0877
7240	XXXX	0.4306	0.5694	10.2496	7.7504	6.1778	6.1778
7240P	XXXX	0.4370	0.5630	9.5706	7.4294	5.9855	5.9855
7242	XXXX	0.4294	0.5706	10.2708	7.7292	6.0707	6.0707
7244	XXXX	0.4283	0.5717	9.7183	7.2817	5.9770	5.9770
7246	XXXX	0.4274	0.5726	9.7347	7.2653	5.8943	5.8943
7248	XXXX	0.4265	0.5735	9.7496	7.2504	5.8207	5.8207
7250	XXXX	0.4257	0.5743	9.7633	7.2367	5.7548	5.7548
7252	XXXX	0.4249	0.5751	9.7759	7.2241	5.6955	5.6955
7256	XXXX	0.4288	0.5712	10.2817	7.7183	6.0172	6.0172
7260	XXXX	0.4306	0.5694	10.2496	7.7504	6.1778	6.1778
7264	XXXX	0.4321	0.5679	10.2218	7.7782	6.3236	6.3236
7300P	XXXX	0.3648	0.6352	4.4458	2.5542	2.6279	2.6279
7300S	XXXX	0.3705	0.6295	4.4063	2.5937	3.2653	3.2653
7301P	XXXX	0.3634	0.6366	4.4556	2.5444	2.5965	2.5965
7301S	XXXX	0.3777	0.6223	6.2228	3.7772	3.4843	3.4843
7302P	XXXX	0.3826	0.6174	4.9388	3.0612	3.0840	3.0840
7303	XXXX	0.3915	0.6085	6.0847	3.9153	3.8419	3.8419
7303P	XXXX	0.3764	0.6236	4.9882	3.0118	2.9117	2.8117
7304	0001	0.3834	0.6166	6.1654	3.8346	3.5487	3.5487
7304P	XXXX	0.3947	0.6053	5.4470	3.5530	3.4789	3.4789
7304PJ	H501	0.3947	0.6053	6.0522	3.9478	3.4789	3.4789
7305	0001	0.4047	0.5953	7.1433	4.8567	4.4232	4.4232
7305P	XXXX	0.3951	0.6049	5.4436	3.5564	3.4925	3.4925
7305PJ	H501	0.3987	0.6013	6.6140	4.3860	3.6271	3.6271
7306	0001	0.4052	0.5948	7.1378	4.8622	4.4465	4.4465
7306P	XXXX	0.3986	0.6014	6.0135	3.9865	3.6239	3.6239
7306PJ	H501	0.3986	0.6014	6.6148	4.3852	3.6239	3.6239
7307	0C01	0.4039	0.5961	7.1533	4.8467	4.3821	4.3821
7307P	XXXX	0.3995	0.6005	6.0047	3.9953	3.6585	3.6585
7307PJ	H501	0.4048	0.5952	6.5469	4.4531	3.8787	3.8787
7308	0001	0.4043	0.5957	7.1477	4.8523	4.4050	4.4050
7308P	XXXX	0.4064	0.5936	6.5290	4.4710	3.9512	3.9512
7308PJ	H501	0.4064	0.5936	7.1225	4.8775	3.9512	3.9512
7309	0001	0.4047	0.5953	7.1433	4.8567	4.4233	4.4233
7309P	XXXX	0.4035	0.5965	6.5610	4.4390	3.8233	3.8233
7309PJ	H501	0.4065	0.5935	7.1221	4.8779	3.9530	3.9530
7310	0001	0.3959	0.6041	7.2496	4.7504	4.0173	4.0173
7310DU	0002	0.3959	0.6041	6.6455	4.3545	4.0173	4.0173
7310P	XXXX	0.4055	0.5945	7.1331	4.8669	3.9118	3.9118

MRC Ball Bearing Vibration Data
Data Based on a Speed of 1 RPM

MRC Bearing Services

Values in Cycles per Minute

Bearing Size	Suffix	Inner Rotation	Outer Rotation	Inner or Outer Ring Rotation		Inner Rotation	Outer Rotation
		Cage Speed Frequency (RPM)	Cage Speed Frequency (RPM)	Inner Ring Frequency	Outer Ring Frequency	Rolling Element Frequency	Rolling Element Frequency
7310PJ	XXXX	0.4055	0.5945	7.1331	4.8669	3.9118	3.9118
7311	0002	0.3943	0.6057	7.2686	4.7314	3.9517	3.9517
7311P	XXXX	0.4063	0.5937	6.5308	4.4692	3.9436	3.9436
7311PJ	H501	0.4063	0.5937	7.1245	4.8755	3.9436	3.9436
7312	0001	0.3977	0.6023	7.2277	4.7723	4.0954	4.0954
7312P	XXXX	0.4072	0.5928	6.5209	4.4791	3.9847	3.9847
7312PJ	H501	0.4073	0.5927	7.1126	4.8874	3.9891	3.9891
7313	0001	0.4056	0.5944	8.3209	5.6791	4.4700	4.4700
7313P	XXXX	0.4080	0.5920	7.1034	4.8966	4.0246	4.0246
7313PJ	H501	0.4080	0.5920	7.1034	4.8966	4.0246	4.0246
7314	0001	0.4053	0.5947	7.1360	4.8640	4.4538	4.4538
7314P	XXXX	0.4088	0.5912	7.0945	4.9055	4.0595	4.0595
7314PJ	H501	0.4088	0.5912	7.0945	4.9055	4.0595	4.0595
7315	0004	0.4059	0.5941	8.3169	5.6831	4.4846	4.4846
7315DT	0003	0.4059	0.5941	8.3169	5.6831	4.4846	4.4846
7315P	XXXX	0.4068	0.5932	6.5246	4.4754	3.9693	3.9693
7315PJ	H501	0.4120	0.5880	7.6436	5.3564	4.2191	4.2191
7316	0001	0.4056	0.5944	7.7274	5.2726	4.4666	4.4666
7316P	XXXX	0.4124	0.5876	7.0507	4.9493	4.2403	4.2403
7316PJ	H501	0.4124	0.5876	7.6383	5.3617	4.2403	4.2403
7317	0001	0.4061	0.5939	8.3138	5.6862	4.4960	4.4960
7317DU	0004	0.4061	0.5939	7.7199	5.2801	4.4960	4.4960
7317P	XXXX	0.4128	0.5872	7.0463	4.9537	4.2593	4.2593
7317PJ	H501	0.4128	0.5872	7.6335	5.3665	4.2593	4.2593
7318	0003	0.4058	0.5942	7.7248	5.2752	4.4767	4.4767
7318P	XXXX	0.4131	0.5869	7.0424	4.9576	4.2764	4.2764
7318PJ	H501	0.4131	0.5869	7.6292	5.3708	4.2764	4.2764
7319	0002	0.4059	0.5941	7.7237	5.2763	4.4810	4.4810
7319P	XXXX	0.4134	0.5866	7.0388	4.9612	4.2918	4.2918
7319PJ	H501	0.4134	0.5866	7.6254	5.3746	4.2918	4.2918
7320	0002	0.4074	0.5926	7.7033	5.2967	4.5624	4.5624
7320P	XXXX	0.4077	0.5923	7.1077	4.8923	4.0080	4.0080
7321	0004	0.4074	0.5926	7.7033	5.2967	4.5624	4.5624
7321P	XXXX	0.4115	0.5885	7.0613	4.9387	4.1952	4.1952
7322	0001	0.4053	0.5947	7.7316	5.2684	4.4504	4.4504
7322P	XXXX	0.4098	0.5902	7.0820	4.9180	4.1099	4.1099
7324	XXXX	0.4044	0.5956	7.7425	5.2575	4.4083	4.4083
7324P	XXXX	0.4104	0.5896	7.0753	4.9247	4.1372	4.1372
7326	XXXX	0.4046	0.5954	7.7401	5.2599	4.4175	4.4175
7326P	XXXX	0.4110	0.5890	7.0678	4.9322	4.1682	4.1682
7328	XXXX	0.4048	0.5952	7.7380	5.2620	4.4256	4.4256
7328P	XXXX	0.4115	0.5885	7.0613	4.9387	4.1952	4.1952
7330	0004	0.4078	0.5922	8.2900	5.7100	4.5849	4.5849
7330P	XXXX	0.4120	0.5880	7.0557	4.9443	4.2191	4.2191
7332	XXXX	0.4078	0.5922	8.2907	5.7093	4.5822	4.5822
7332P	XXXX	0.4148	0.5852	7.0215	4.9785	4.3690	4.3690
7334	XXXX	0.4103	0.5897	8.2551	5.7449	4.7210	4.7210
7334P	XXXX	0.4174	0.5826	7.5738	5.4262	4.5104	4.5104
7336	XXXX	0.4107	0.5893	8.2496	5.7504	4.7432	4.7432
7336P	XXXX	0.4175	0.5825	7.5728	5.4272	4.5151	4.5151
7338	XXXX	0.4106	0.5894	8.2520	5.7480	4.7338	4.7338
7338P	XXXX	0.4196	0.5804	7.5450	5.4550	4.6416	4.6416
7340	XXXX	0.4104	0.5896	8.2541	5.7459	4.7252	4.7252
7340P	XXXX	0.4215	0.5785	8.0984	5.9016	4.7617	4.7617
7342	XXXX	0.4103	0.5897	8.2560	5.7440	4.7175	4.7175
7344	XXXX	0.4101	0.5899	8.2578	5.7422	4.7104	4.7104
7348	XXXX	0.4137	0.5863	8.2083	5.7917	4.9158	4.9158
7352	XXXX	0.4167	0.5833	8.7496	6.2504	5.1036	5.1036
7356	XXXX	0.4160	0.5840	8.7593	6.2407	5.0621	5.0621
7403	XXXX	0.3594	0.6406	5.1248	2.8752	2.8642	2.8642
7404	0002	0.3648	0.6352	5.0812	2.9188	2.9993	2.9993
7405	XXXX	0.3678	0.6322	5.6901	3.3099	3.0759	3.0759

Values in Cycles per Minute

Bearing Size	Suffix	Inner Rotation	Outer Rotation	Inner or Outer Ring Rotation		Inner Rotation	Outer Rotation
		Cage Speed Frequency (RPM)	Cage Speed Frequency (RPM)	Inner Ring Frequency	Outer Ring Frequency	Rolling Element Frequency	Rolling Element Frequency
7405P	H501	0.3936	0.6064	6.0639	3.9361	3.4372	3.4372
7406	0001	0.3733	0.6267	6.2664	3.7336	3.2316	3.2316
7406P	H501	0.3938	0.6062	6.0615	3.9385	3.4456	3.4456
7407	XXXX	0.3772	0.6228	6.2280	3.7720	3.3463	3.3463
7407P	H501	0.3937	0.6063	6.0627	3.9373	3.4413	3.4413
7408	0001	0.3803	0.6197	6.1973	3.8027	3.4430	3.4430
7408P	H501	0.3948	0.6052	6.0514	3.9486	3.4817	3.4817
7409	XXXX	0.3822	0.6178	6.1781	3.8219	3.5060	3.5060
7409P	H501	0.3934	0.6066	6.0662	3.9338	3.4292	3.4292
7410	XXXX	0.3843	0.6157	6.7728	4.2272	3.5771	3.5771
7410P	H501	0.3955	0.6045	6.0448	3.9552	3.5059	3.5059
7411	XXXX	0.3861	0.6139	6.7532	4.2468	3.6393	3.6393
7411P	H501	0.3942	0.6058	6.0576	3.9424	3.4596	3.4596
7412	XXXX	0.3876	0.6124	6.7364	4.2636	3.6941	3.6941
7412P	H501	0.3960	0.6040	6.0399	3.9601	3.5240	3.5240
7413	XXXX	0.3889	0.6111	6.7218	4.2782	3.7428	3.7428
7413P	H501	0.3975	0.6025	6.0245	3.9755	3.5815	3.5815
7414	XXXX	0.3834	0.6166	6.7829	4.2171	3.5455	3.5455
7414P	H501	0.3932	0.6068	6.0676	3.9324	3.4241	3.4241
7415	XXXX	0.3847	0.6153	6.7679	4.2321	3.5923	3.5923
7415P	H501	0.3947	0.6053	6.0530	3.9470	3.4760	3.4760
7416	XXXX	0.3859	0.6141	6.7546	4.2454	3.6348	3.6348
7416P	H501	0.3957	0.6043	6.0424	3.9576	3.5146	3.5146
7417	XXXX	0.3870	0.6130	6.7425	4.2575	3.6738	3.6738
7417P	XXXX	0.3971	0.6029	6.0286	3.9714	3.5660	3.5660
7418	XXXX	0.3854	0.6146	6.7606	4.2394	3.6154	3.6154
7418P	XXXX	0.3957	0.6043	6.0424	3.9576	3.5146	3.5146
7419	XXXX	0.3873	0.6127	6.7395	4.2605	3.6837	3.6837
7419P	H501	0.3897	0.6103	6.1025	3.8975	3.4457	3.4457
7420	XXXX	0.3859	0.6141	6.7553	4.2447	3.6324	3.6324
7420P	H501	0.3888	0.6112	6.1116	3.8884	3.4147	3.4147
7421	XXXX	0.3805	0.6195	6.1951	3.8049	3.4500	3.4500
7422	XXXX	0.3805	0.6195	6.1947	3.8053	3.4514	3.4514
8008	H401	0.3806	0.6194	4.3360	2.6640	3.7585	3.7585
8013	H401	0.3726	0.6274	4.3916	2.6084	3.5338	3.5338
8014	H401	0.3830	0.6170	4.9357	3.0643	3.8900	3.8900
8016	H401	0.3876	0.6124	4.8990	3.1010	4.0669	4.0669
8026	H401	0.4015	0.5985	5.3866	3.6134	4.7226	4.7226
8038	H401	0.3740	0.6260	4.3818	2.6182	3.5388	3.5388
8218A	0001	0.4297	0.5703	8.5542	6.4458	5.3424	5.3424
8218B	0001	0.4144	0.5856	8.7842	6.2158	5.4760	5.4760
8219A	0001	0.4291	0.5709	8.5630	6.4370	5.2960	5.2960
8219B	0001	0.4195	0.5805	9.2875	6.7125	5.8464	5.8464
8220A	XXXX	0.4307	0.5693	8.5386	6.4614	5.4257	5.4257
8220B	XXXX	0.4188	0.5812	9.2990	6.7010	5.7917	5.7917
8222A	0001	0.4296	0.5704	8.5553	6.4447	5.3365	5.3365
8222B	0001	0.4169	0.5831	9.3295	6.6705	5.6516	5.6516
8224A	0001	0.4313	0.5687	8.5308	6.4692	5.4681	5.4681
8224B	0001	0.4178	0.5822	9.3153	6.6847	5.7164	5.7164
8238A	XXXX	0.4382	0.5618	9.5498	7.4502	6.1079	6.1079
8238B	XXXX	0.4220	0.5780	9.8258	7.1742	6.0419	6.0419
8308A	OC01	0.4017	0.5983	5.9823	4.0177	3.7488	3.7488
8308B	OC01	0.3944	0.6056	7.2675	4.7325	4.3682	4.3682
8309A	OC01	0.4035	0.5965	6.5610	4.4390	3.8233	3.8233
8309B	OC01	0.3948	0.6052	7.2627	4.7373	4.3866	4.3866
8310A	OC01	0.4050	0.5950	6.5451	4.4549	3.8857	3.8857
8310B	OC01	0.3832	0.6168	6.7843	4.2157	3.9111	3.9111
8311A	0001	0.4062	0.5938	6.5320	4.4680	3.9389	3.9389
8311B	0001	0.3832	0.6168	6.7843	4.2157	3.9111	3.9111
8312A	0001	0.4072	0.5928	6.5209	4.4791	3.9847	3.9847
8312B	0001	0.3870	0.6130	6.7429	4.2571	4.0561	4.0561
8313A	0001	0.4080	0.5920	6.5115	4.4885	4.0246	4.0246

MRC Ball Bearing Vibration Data
Data Based on a Speed of 1 RPM

MRC Bearing Services

Values in Cycles per Minute

Bearing Size	Suffix	Inner Rotation	Outer Rotation	Inner or Outer Ring Rotation		Inner Rotation	Outer Rotation
		Cage Speed Frequency (RPM)	Cage Speed Frequency (RPM)	Inner Ring Frequency	Outer Ring Frequency	Rolling Element Frequency	Rolling Element Frequency
8313B	0001	0.3958	0.6042	7.2504	4.7496	4.4338	4.4338
8314A	0001	0.4060	0.5940	6.5337	4.4663	3.9320	3.9320
8314B	0001	0.3960	0.6040	7.2484	4.7516	4.4416	4.4416
8315A	0001	0.4068	0.5932	6.5246	4.4754	3.9693	3.9693
8315B	0001	0.3961	0.6039	7.8505	5.1495	4.4484	4.4484
8316A	0001	0.4076	0.5924	6.5166	4.4834	4.0027	4.0027
8316B	0001	0.3962	0.6038	7.8488	5.1512	4.4545	4.4545
8317A	0001	0.4082	0.5918	6.5096	4.4904	4.0327	4.0327
8317B	0001	0.3964	0.6036	7.8473	5.1527	4.4600	4.4600
8318A	0001	0.4088	0.5912	6.5033	4.4967	4.0597	4.0597
8318B	0001	0.3959	0.6041	7.8527	5.1473	4.4405	4.4405
8319A	0001	0.4093	0.5907	6.4976	4.5024	4.0844	4.0844
8319B	0001	0.3966	0.6034	7.8448	5.1552	4.4690	4.4690
8320A	0001	0.4112	0.5888	7.0655	4.9345	4.1776	4.1776
8320B	0001	0.3983	0.6017	7.8223	5.1777	4.5515	4.5515
8322A	0001	0.4131	0.5869	7.0424	4.9576	4.2764	4.2764
8322B	0001	0.3954	0.6046	7.8601	5.1399	4.4140	4.4140
8326A	0001	0.4110	0.5890	7.0678	4.9322	4.1682	4.1682
8326B	0001	0.3946	0.6054	7.8695	5.1305	4.3809	4.3809
8330A	0002	0.4120	0.5880	7.0557	4.9443	4.2191	4.2191
8330B	0002	0.3982	0.6018	7.8229	5.1771	4.5495	4.5495
8336A	0002	0.4175	0.5825	7.5728	5.4272	4.5151	4.5151
8500	H401	0.3885	0.6115	4.8921	3.1079	4.0904	4.0904
8501	H401	0.3517	0.6483	4.5379	2.4621	2.9741	2.9741
8502	H401	0.3876	0.6124	4.8991	3.1009	4.0665	4.0665
8503	H401	0.3875	0.6125	4.8999	3.1001	4.0810	4.0810
8504	H401	0.3886	0.6114	4.8908	3.1092	4.1310	4.1310
8505	H401	0.4015	0.5985	5.3866	3.6134	4.7226	4.7226
8506	H401	0.3992	0.6008	5.4070	3.5930	4.6332	4.6332
8507	H401	0.3990	0.6010	5.4093	3.5907	4.6178	4.6178
8508	H401	0.4033	0.5967	5.3705	3.6295	4.8503	4.8503
8605	H401	0.3712	0.6288	4.4014	2.5986	3.5288	3.5288
87007	H401	0.3781	0.6219	4.3534	2.6466	3.6726	3.6726
87008	H401	0.3819	0.6181	4.3267	2.6733	3.8058	3.8058
87013	H401	0.3726	0.6274	4.3916	2.6084	3.5338	3.5338
87014	H401	0.3830	0.6170	4.9357	3.0643	3.8900	3.8900
87016	H401	0.3876	0.6124	4.8990	3.1010	4.0669	4.0669
87026	H401	0.4015	0.5985	5.3866	3.6134	4.7226	4.7226
87036	H401	0.3488	0.6512	3.9071	2.0929	2.8606	2.8606
87037	H401	0.3697	0.6303	4.4123	2.5877	3.4045	3.4045
87038	H401	0.3740	0.6260	4.3818	2.6182	3.5388	3.5388
87500	H401	0.3885	0.6115	4.8921	3.1079	4.0904	4.0904
87501	H401	0.3697	0.6303	4.4119	2.5881	3.4441	3.4441
87502	H401	0.3876	0.6124	4.8991	3.1009	4.0665	4.0665
87503	H401	0.3875	0.6125	4.8999	3.1001	4.0810	4.0810
87504	H401	0.3886	0.6114	4.8908	3.1092	4.1310	4.1310
87505	H401	0.4015	0.5985	5.3866	3.6134	4.7226	4.7226
87506	H401	0.3992	0.6008	5.4070	3.5930	4.6332	4.6332
87507	H401	0.3990	0.6010	5.4093	3.5907	4.6178	4.6178
87508	H401	0.4033	0.5967	5.3705	3.6295	4.8503	4.8503
88007	H401	0.3781	0.6219	4.3534	2.6466	3.6726	3.6726
88008	H401	0.3819	0.6181	4.3267	2.6733	3.8058	3.8058
88009	H401	0.3828	0.6172	4.3206	2.6794	3.8693	3.8693
88011	H401	0.3667	0.6333	4.4330	2.5670	3.3547	3.3547
88013	H401	0.3726	0.6274	4.3916	2.6084	3.5338	3.5338
88016	H401	0.3882	0.6118	4.2824	2.7176	4.0688	4.0688
88500	H401	0.3885	0.6115	4.8921	3.1079	4.0904	4.0904
88501	H401	0.3697	0.6303	4.4119	2.5881	3.4441	3.4441
88502	H401	0.3876	0.6124	4.8991	3.1009	4.0665	4.0665
88503	H401	0.3875	0.6125	4.8999	3.1001	4.0810	4.0810
88504	H401	0.3886	0.6114	4.8908	3.1092	4.1310	4.1310
88505	H401	0.4015	0.5985	5.3866	3.6134	4.7226	4.7226

Values in Cycles per Minute

Bearing Size	Suffix	Inner Rotation	Outer Rotation	Inner or Outer Ring Rotation		Inner Rotation	Outer Rotation
		Cage Speed Frequency (RPM)	Cage Speed Frequency (RPM)	Inner Ring Frequency	Outer Ring Frequency	Rolling Element Frequency	Rolling Element Frequency
88506	H401	0.3992	0.6008	5.4070	3.5930	4.6332	4.6332
88507	H401	0.3990	0.6010	5.4093	3.5907	4.6178	4.6178
88508	H401	0.4033	0.5967	5.3705	3.6295	4.8503	4.8503
9202U	XXXX	0.3889	0.6111	6.1107	3.8893	3.7429	3.7429
9202UP	XXXX	0.3905	0.6095	4.8757	3.1243	3.3314	3.3314
9203U	XXXX	0.3904	0.6096	6.0959	3.9041	3.7987	3.7987
9203UP	XXXX	0.3933	0.6067	5.4600	3.5400	3.4273	3.4273
9204U	XXXX	0.4067	0.5933	7.1189	4.8811	4.5272	4.5272
9204UP	XXXX	0.4001	0.5999	5.9984	4.0016	3.6833	3.6833
9205U	XXXX	0.4098	0.5902	7.0819	4.9181	4.6925	4.6925
9205UP	XXXX	0.4131	0.5869	7.0425	4.9575	4.2759	4.2759
9206U	XXXX	0.4245	0.5755	8.0564	5.9436	5.6632	5.6632
9206UP	XXXX	0.4140	0.5860	6.4452	4.5548	4.3256	4.3256
9207U	XXXX	0.4221	0.5779	8.0900	5.9100	5.4806	5.4806
9207UP	XXXX	0.4147	0.5853	7.0230	4.9770	5.3624	5.3624
9208U	0005	0.4190	0.5810	8.1339	5.8661	5.2576	5.2576
9208UP	XXXX	0.4189	0.5811	6.9729	5.0271	4.6002	4.6002
9209U	XXXX	0.4252	0.5748	8.0467	5.9533	5.7186	5.7186
9209UP	XXXX	0.4205	0.5795	7.5338	5.4662	4.6948	4.6948
9210U	XXXX	0.4306	0.5694	9.1108	6.8892	6.1778	6.1778
9210UP	XXXX	0.4261	0.5739	8.0338	5.9662	5.0740	5.0740
9211U	0003	0.4194	0.5806	8.1287	5.8713	5.2833	5.2833
9211UP	XXXX	0.4254	0.5746	8.0436	5.9564	5.0242	5.0242
9212U	XXXX	0.4265	0.5735	9.1761	6.8239	5.8208	5.8208
9212UP	XXXX	0.4249	0.5751	8.0516	5.9484	4.9840	4.9840
9213U	XXXX	0.4249	0.5751	9.2008	6.7992	5.6956	5.6956
9213UP	XXXX	0.4277	0.5723	8.0123	5.9877	5.1864	5.1864
9214U	XXXX	0.4288	0.5712	9.1392	6.8608	6.0172	6.0172
9214UP	XXXX	0.4283	0.5717	8.0041	5.9959	5.2304	5.2304
9215U	0002	0.4255	0.5745	9.7665	7.2335	5.7395	5.7395
9215UP	XXXX	0.4317	0.5683	8.5239	6.4761	5.5069	5.5069
9216U	XXXX	0.4306	0.5694	9.1108	6.8892	6.1778	6.1778
9216UP	XXXX	0.4309	0.5691	8.5365	6.4635	5.4371	5.4371
9217U	XXXX	0.4291	0.5709	9.7053	7.2947	6.0440	6.0440
9217UP	XXXX	0.4301	0.5699	8.5480	6.4520	5.3753	5.3753
9218U	XXXX	0.4222	0.5778	9.2441	6.7559	5.4882	5.4882
9218UP	XXXX	0.4294	0.5706	8.5581	6.4419	5.3220	5.3220
9219U	XXXX	0.4266	0.5734	9.7470	7.2530	5.8335	5.8335
9219UP	XXXX	0.4288	0.5712	8.5670	6.4330	5.2756	5.2756
9220U	XXXX	0.4256	0.5744	9.7645	7.2355	5.7491	5.7491
9220UP	XXXX	0.4305	0.5695	8.5424	6.4576	5.4053	5.4053
9221U	XXXX	0.4247	0.5753	9.2049	6.7951	5.6754	5.6754
9221UP	XXXX	0.4299	0.5701	8.5512	6.4488	5.3581	5.3581
9222U	0002	0.4238	0.5762	9.2183	6.7817	5.6102	5.6102
9222UP	XXXX	0.4294	0.5706	8.5592	6.4408	5.3162	5.3162
9302U	XXXX	0.3904	0.6096	6.0963	3.9037	3.7972	3.7972
9302UP	XXXX	0.3826	0.6174	4.9388	3.0612	3.0840	3.0840
9303U	XXXX	0.3915	0.6085	6.0847	3.9153	3.8419	3.8419
9303UP	XXXX	0.3764	0.6236	4.9882	3.0118	2.9117	2.9117
9304U	XXXX	0.3843	0.6157	6.1571	3.8429	3.5771	3.5771
9304UP	XXXX	0.3902	0.6098	5.4882	3.5118	3.3200	3.3201
9305U	0008	0.4042	0.5958	7.1491	4.8509	4.3994	4.3994
9305UP	XXXX	0.3951	0.6049	5.4436	3.5564	3.4925	3.4925
9306U	XXXX	0.4047	0.5953	7.1434	4.8566	4.4228	4.4228
9306UP	XXXX	0.3986	0.6014	6.0135	3.9865	3.6239	3.6239
9307U	0C01	0.4034	0.5966	7.1591	4.8409	4.3586	4.3586
9307UP	XXXX	0.3995	0.6005	6.0047	3.9953	3.6585	3.6585
9308U	XXXX	0.4039	0.5961	7.1535	4.8465	4.3814	4.3814
9308UP	XXXX	0.4017	0.5983	5.9823	4.0177	3.7488	3.7488
9309U	0C01	0.4042	0.5958	7.1490	4.8510	4.3995	4.3995
9309UP	XXXX	0.4035	0.5965	6.5610	4.4390	3.8233	3.8233
9310U	0001	0.3959	0.6041	7.2496	4.7504	4.0173	4.0173

MRC Ball Bearing Vibration Data
Data Based on a Speed of 1 RPM

MRC Bearing Services

Values in Cycles per Minute

Bearing Size	Suffix	Inner Rotation	Outer Rotation	Inner or Outer Ring Rotation		Inner Rotation	Outer Rotation
		Cage Speed Frequency (RPM)	Cage Speed Frequency (RPM)	Inner Ring Frequency	Outer Ring Frequency	Rolling Element Frequency	Rolling Element Frequency
9310UP	XXXX	0.4050	0.5950	6.5451	4.4549	3.8857	3.8857
9311U	0002	0.3968	0.6032	7.2377	4.7623	4.0595	4.0595
9311UP	XXXX	0.4062	0.5938	6.5320	4.4680	3.9389	3.9389
9312U	XXXX	0.3977	0.6023	7.2277	4.7723	4.0956	4.0956
9312UP	XXXX	0.4072	0.5928	6.5209	4.4791	3.9847	3.9847
9313U	XXXX	0.4052	0.5948	8.3275	5.6725	4.4461	4.4461
9313UP	XXXX	0.4080	0.5920	6.5115	4.4885	4.0246	4.0246
9314U	0006	0.4053	0.5947	7.1360	4.8640	4.4538	4.4538
9314UP	XXXX	0.4060	0.5940	6.5337	4.4663	3.9320	3.9320
9315U	XXXX	0.4055	0.5945	8.3235	5.6765	4.4606	4.4606
9315UP	XXXX	0.4068	0.5932	6.5246	4.4754	3.9693	3.9693
9316U	XXXX	0.4056	0.5944	7.7274	5.2726	4.4667	4.4667
9316UP	XXXX	0.4076	0.5924	6.5166	4.4834	4.0027	4.0027
9317U	XXXX	0.4057	0.5943	8.3203	5.6797	4.4720	4.4720
9317UP	XXXX	0.4082	0.5918	6.5096	4.4904	4.0327	4.0327
9318U	0004	0.4058	0.5942	7.7248	5.2752	4.4767	4.4767
9318UP	0001	0.4088	0.5912	6.5033	4.4967	4.0597	4.0597
9319U	XXXX	0.4059	0.5941	7.7237	5.2763	4.4810	4.4810
9319UP	XXXX	0.4093	0.5907	6.4976	4.5024	4.0844	4.0844
9320U	0001	0.4074	0.5926	7.7033	5.2967	4.5625	4.5625
9320UP	XXXX	0.4112	0.5888	7.0655	4.9345	4.1776	4.1776
9321U	XXXX	0.4074	0.5926	7.7033	5.2967	4.5625	4.5625
9321UP	XXXX	0.4115	0.5885	7.0613	4.9387	4.1952	4.1952
9322U	0002	0.4048	0.5952	7.7377	5.2623	4.4267	4.4267
9322UP	XXXX	0.4131	0.5869	7.0424	4.9576	4.2764	4.2764
J078DF	0002	0.4539	0.5461	8.1909	6.8091	5.3819	5.3819
J093DF	XXXX	0.4669	0.5331	11.1938	9.8062	7.5338	7.5338
J098DF	XXXX	0.4669	0.5331	11.1938	9.8062	7.5338	7.5338
J150DF	0004	0.4711	0.5289	12.6921	11.3079	8.6404	8.6404
J175DF	0002	0.4737	0.5263	13.6841	12.3159	9.4757	9.4757
J225DF	XXXX	0.4784	0.5216	16.6905	15.3095	11.5648	11.5648
J300DF	XXXX	0.4829	0.5171	21.1991	19.8009	14.6445	14.6445
J400DF	XXXX	0.4807	0.5193	19.2146	17.7854	12.9258	12.9258
R10	H401	0.4125	0.5875	5.8746	4.1254	5.3940	5.3940
R10	H501	0.3906	0.6094	4.8752	3.1248	4.3516	4.3516
R12	H401	0.4001	0.5999	5.3987	3.6013	4.6873	4.6873
R12	H501	0.3947	0.6053	5.4474	3.5536	4.5395	4.5395
R14	H401	0.4128	0.5872	5.8720	4.1280	5.4204	5.4204
R14	H501	0.3977	0.6023	4.8183	3.1817	4.6834	4.6834
R16	H401	0.4174	0.5826	5.8255	4.1745	5.7446	5.7446
R16	H501	0.4167	0.5833	5.8333	4.1667	5.8333	5.8333
R18	H401	0.4178	0.5822	5.8219	4.1781	5.7874	5.7874
R18	H501	0.4134	0.5866	5.8655	4.1345	5.6036	5.6036
R2	H501	0.3866	0.6134	4.2939	2.7061	3.9308	3.9308
R20	H401	0.4216	0.5784	6.9409	5.0591	6.0816	6.0816
R20	H501	0.4196	0.5804	6.3841	4.6159	6.0604	6.0604
R24	XXXX	0.4284	0.5716	6.8593	5.1407	6.6884	6.6884
R24	H501	0.4167	0.5833	6.4168	4.5832	5.8324	5.8324
R2A	H401	0.3866	0.6134	4.2939	2.7061	3.9308	3.9308
R3	H401	0.3685	0.6315	4.4202	2.5798	3.3990	3.3990
R4	H501	0.3971	0.6029	4.8233	3.1767	4.4666	4.4666
R4A	H501	0.3787	0.6213	4.3487	2.6513	3.7648	3.7648
R6	H401	0.3782	0.6218	4.3529	2.6471	3.7673	3.7673
R8	H501	0.3869	0.6131	4.9045	3.0955	4.0844	4.0844
WC87008	H401	0.3819	0.6181	4.3267	2.6733	3.8058	3.8058
WC87016	H401	0.3876	0.6124	4.8990	3.1010	4.0669	4.0669
WC87500	H401	0.3885	0.6115	4.8921	3.1079	4.0904	4.0904
WC87501	H401	0.3697	0.6303	4.4119	2.5881	3.4441	3.4441
WC87502	H401	0.3876	0.6124	4.8991	3.1009	4.0665	4.0665
WC87503	H401	0.3875	0.6125	4.8999	3.1001	4.0810	4.0810
WC87504	H401	0.3886	0.6114	4.8908	3.1092	4.1310	4.1310
XLS10	0007	0.4651	0.5349	18.7216	16.2784	13.1869	13.1869

Values in Cycles per Minute

Bearing Size	Suffix	Inner Rotation	Outer Rotation	Inner or Outer Ring Rotation		Inner Rotation	Outer Rotation
		Cage Speed Frequency (RPM)	Cage Speed Frequency (RPM)	Inner Ring Frequency (Hz.)	Outer Ring Frequency (Hz.)	Rolling Element Frequency (Hz.)	Rolling Element Frequency (Hz.)
XLS11V2	0003	0.4204	0.5796	8.6947	6.3053	5.9073	5.9073
XLS13V4	0003	0.4319	0.5681	9.6573	7.3427	6.9336	6.9336
XLS13V8	XXXX	0.4157	0.5843	8.1802	5.8198	5.5638	5.5638
XLS15V8	0008	0.4261	0.5739	9.1816	6.8184	6.3699	6.3699
XLS17V8	XXXX	0.4295	0.5705	9.6984	7.3016	6.7054	6.7054
XLS2	0007	0.4322	0.5678	10.2207	7.7793	6.9236	6.9236
XLS21V2	XXXX	0.4437	0.5563	11.6818	9.3182	8.3923	8.3923
XLS21V2S	0003	0.4435	0.5565	8.3474	6.6526	8.3586	8.3586
XLS21V4	0C01	0.4380	0.5620	10.6772	8.3228	7.6015	7.6015
XLS21V8	0002	0.4339	0.5661	10.1900	7.8100	7.2575	7.2575
XLS23V4	0004	0.4389	0.5611	11.2217	8.7783	7.7174	7.7174
XLS25V8	XXXX	0.4380	0.5620	11.2407	8.7593	7.5955	7.5955
XLS3	0007	0.4440	0.5560	12.2324	9.7676	8.4346	8.4346
XLS31V2	0008	0.4510	0.5490	13.7261	11.2739	9.5925	9.5925
XLS31V4	0004	0.4479	0.5521	12.6987	10.3013	9.0153	9.0153
XLS33V4	0006	0.4537	0.5463	14.2041	11.7959	10.1692	10.1692
XLS41V2	0006	0.4557	0.5443	14.6964	12.3036	10.6358	10.6358
XLS41V4	0015	0.4535	0.5465	14.2084	11.7916	10.1317	10.1317
XLS43V4	0008	0.4581	0.5419	15.1729	12.8271	11.1412	11.1412
XLS5	0009	0.4555	0.5445	14.7016	12.2984	10.5513	10.5513
XLS51V2	0006	0.4589	0.5411	15.6911	13.3089	11.4467	11.4467
XLS6	0010	0.4621	0.5379	16.6737	14.3263	12.3422	12.3422
XLS61V2	0005	0.4614	0.5386	16.6961	14.3039	12.0955	12.0955
XLS61V4	0008	0.4598	0.5402	16.2058	13.7942	11.6920	11.6920
XLS7	0007	0.4605	0.5395	16.7234	14.2766	11.8927	11.8927
XLS71V4	0007	0.4621	0.5379	17.2138	14.7862	12.2599	12.2599
XLS73V4	XXXX	0.4613	0.5387	16.6987	14.3013	12.0939	12.0939
XLS8	0005	0.4625	0.5375	17.1989	14.8011	12.3967	12.3967
XLS81V2	XXXX	0.4618	0.5382	17.2215	14.7785	12.2360	12.2360
XLS81V4	XXXX	0.4636	0.5364	17.7010	15.2990	12.7653	12.7653
XLS9	0002	0.4609	0.5391	16.7106	14.2894	11.8984	11.8984
XO155RBDS	0002	0.4276	0.5724	9.1591	6.8409	6.5267	6.5267
XO155RBDS	0001	0.4276	0.5724	9.1591	6.8409	6.5267	6.5267
XO155RBDS	0004	0.4276	0.5724	9.1591	6.8409	6.5267	6.5267
XO165RBDS	0002	0.4138	0.5862	8.7936	6.2064	5.4336	5.4336
XO30RBDS	0002	0.3864	0.6136	5.5227	3.4773	4.0305	4.0305
XO57RBDS	0002	0.3991	0.6009	7.2103	4.7897	4.5937	4.5937
XO57RBDS	0001	0.3991	0.6009	7.2103	4.7897	4.5937	4.5937
XO67RBDS	0005	0.4095	0.5905	7.6771	5.3229	5.1590	5.1590
XO67RBDS	0001	0.4095	0.5905	7.6771	5.3229	5.1590	5.1590
XO90RBDS	0005	0.4062	0.5938	7.7191	5.2809	4.9688	4.9688
XO90RBDS	0003	0.4062	0.5938	7.7191	5.2809	4.9688	4.9688
XO90RBDS	0002	0.4062	0.5938	7.7191	5.2809	4.9688	4.9688
XO90RBDS	0001	0.4062	0.5938	7.7191	5.2809	4.9688	4.9688

NOTES

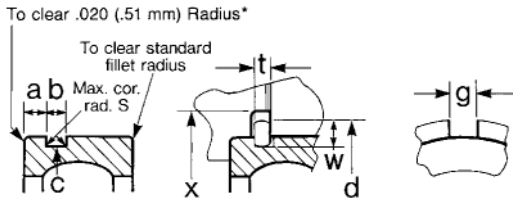

*Where standard bearing corner is .020 (.51 mm) or less, this corner remains same as standard.

Snap-ring mounting data on these pages conforms to ABMA Standard 20.

5200 and 5300 Series—use dimensions listed for 200 and 300 series.

Cartridge Width Bearings—“a” dimension varies depending on bearing size. Dimensions shown on page 327.

Basic Bearing				Dimensions of Ring, Groove and Housing															Counter-bore								
1900	100K	200	300	Groove								Ring						x									
				a		b		c		s		d		t		w				g							
				inch max.	inch min.	mm max.	mm min.	inch max.	inch min.	mm max.	mm min.	inch max.	inch min.	mm max.	mm min.	inch	mm	inch	mm	inch	mm	inch	mm	Minimum inch	mm		
1900				.041	.035	1.05	.90	.041	.031	1.05	.80	.819	.807	20.8	20.5	.008	.20	.984	25.0	.026	.65	.076	1.93	.094	2.5	1.016	25.8
1901				.051	.045	1.30	1.15	.047	.037	1.20	.95	1.130	1.118	28.7	28.4	.010	.25	1.06	27.0	.026	.65	.076	1.93	.094	2.5	1.094	27.8
1902				.067	.061	1.70	1.55	.047	.037	1.20	.95	1.051	1.039	26.7	26.4	.010	.25	1.20	30.6	.031	.80	.078	1.98	.125	3.0	1.234	31.3
1903	101K	200	300	.068	.062	1.73	1.57	.047	.037	1.20	.95	1.050	1.040	26.7	26.4	.016	.40	1.20	30.6	.031	.80	.078	1.98	.125	3.0	1.234	31.3
				.051	.045	1.30	1.15	.047	.037	1.20	.95	1.130	1.118	28.7	28.4	.010	.25	1.28	32.5	.031	.80	.078	1.98	.125	3.0	1.312	33.3
1904	102K	201	300	.081	.075	2.06	1.90	.065	.053	1.65	1.35	1.187	1.177	30.2	29.0	.016	.40	1.44	36.5	.042	1.07	.125	3.18	.125	3.0	1.469	37.3
				103K	202	.081	.075	2.06	1.90	.065	.053	1.65	1.35	1.306	1.296	33.2	32.9	.016	.40	1.55	39.3	.042	1.07	.125	3.18	.125	3.0
1905	203	301	300	.081	.075	2.06	1.90	.065	.053	1.65	1.35	1.369	1.359	34.8	34.5	.016	.40	1.61	40.9	.042	1.07	.125	3.18	.125	3.0	1.641	41.7
				.081	.075	2.06	1.90	.065	.053	1.65	1.35	1.500	1.490	38.1	37.9	.016	.40	1.75	44.5	.042	1.07	.125	3.18	.125	3.0	1.781	45.2
1906	104K	302	300	.081	.075	2.06	1.90	.065	.053	1.65	1.35	1.565	1.555	39.8	38.5	.016	.40	1.81	46.0	.042	1.07	.125	3.18	.125	3.0	1.844	46.8
				105K	.067	.061	1.70	1.55	.047	.037	1.20	.95	1.799	1.787	45.7	45.4	.010	.25	1.95	49.6	.031	.80	.078	1.98	.125	3.0	1.984
1907	204	303	304	.097	.091	2.46	2.31	.065	.053	1.65	1.35	1.756	1.746	44.6	44.4	.016	.40	2.06	52.4	.042	1.07	.156	3.96	.125	3.0	2.094	53.2
				205	.097	.091	2.46	2.31	.065	.053	1.65	1.35	1.958	1.948	49.7	49.5	.016	.40	2.27	57.6	.042	1.07	.156	3.96	.188	5.0	2.297
1908	106K	206	305	.082	.074	2.08	1.88	.065	.053	1.65	1.35	2.071	2.061	52.8	52.4	.016	.40	2.38	60.3	.042	1.07	.156	3.96	.188	5.0	2.406	61.1
				107K	.067	.061	1.70	1.55	.047	.037	1.20	.95	2.390	2.374	60.7	60.3	.010	.25	2.56	65.1	.031	.80	.078	1.98	.188	5.0	2.594
1909	108K	208	306	.098	.090	2.49	2.20	.087	.075	2.20	1.90	2.347	2.327	59.6	59.1	.024	.60	2.66	67.5	.065	1.65	.156	3.96	.188	5.0	2.688	68.3
				.067	.061	1.70	1.55	.047	.037	1.20	.95	2.626	2.610	66.7	66.3	.010	.25	2.80	71.0	.031	.80	.078	1.98	.188	5.0	2.828	71.8
1910	109K	207	306	.067	.061	1.70	1.55	.047	.037	1.20	.95	2.783	2.769	70.7	70.3	.010	.25	2.95	75.0	.031	.80	.078	1.98	.188	5.0	2.984	75.8
				.129	.121	3.28	3.07	.087	.075	2.20	1.90	2.709	2.689	68.8	68.3	.024	.60	3.08	78.2	.065	1.65	.188	4.78	.188	5.0	3.141	79.8
1911	110K	208	307	.083	.075	2.11	1.9	.063	.051	1.60	1.30	3.067	3.051	77.9	77.5	.016	.40	3.31	84.1	.042	1.07	.125	3.18	.188	5.0	3.375	85.7
				.098	.090	2.49	2.20	.087	.075	2.20	1.90	3.024	3.004	76.8	76.3	.024	.60	3.40	86.5	.065	1.65	.188	4.78	.188	5.0	3.469	88.1
1912	111K	210	308	.083	.075	2.1	1.9	.063	.051	1.60	1.30	3.264	3.248	82.9	82.5	.016	.40	3.52	89.3	.042	1.07	.125	3.18	.188	5.0	3.578	90.9
				.129	.121	3.28	3.07	.087	.075	2.20	1.90	3.221	3.201	81.8	81.3	.024	.60	3.59	91.3	.065	1.65	.188	4.78	.188	5.0	3.656	92.9
1913	112K	211	309	.083	.075	2.1	1.9	.063	.051	1.60	1.30	3.461	3.445	87.9	87.5	.016	.40	3.70	94.1	.042	1.07	.125	3.18	.188	5.0	3.766	95.7
				.113	.105	2.87	2.67	.118	.106	3.00	2.70	3.417	3.397	86.8	86.3	.024	.60	3.80	96.4	.095	2.41	.188	4.78	.188	5.0	3.859	98.0
1914	113K	211	309	.129	.121	3.28	3.07	.118	.106	3.00	2.70	3.615	3.595	91.8	91.3	.024	.60	3.98	101.2	.095	2.41	.188	4.78	.188	5.0	4.047	102.9
				.098	.090	2.5	2.3	.063	.051	1.60	1.30	3.854	3.838	97.9	97.5	.016	.40	4.11	104.4	.042	1.07	.125	3.18	.188	5.0	4.172	106.0
				.113	.105	2.87	2.67	.118	.106	3.00	2.70	3.811	3.791	96.8	96.3	.024	.60	4.19	106.4	.095	2.41	.188	4.78	.188	5.0	4.250	108.0
				.129	.121	3.28	3.07	.118	.106	3.00	2.70	3.811	3.791	96.8	96.3	.024	.60	4.19	106.4	.095	2.41	.188	4.78	.188	5.0	4.250	108.0

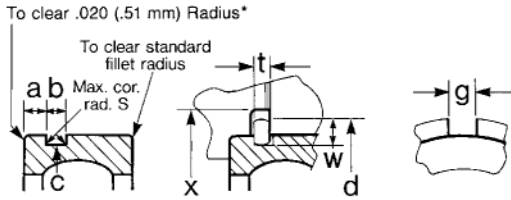

*Where standard bearing corner is .020 (.51 mm) or less, this corner remains same as standard.

Basic Bearing				Dimensions of Ring, Groove and Housing															Counter-bore								
1900	100K	200	300	Groove								Ring						x									
				a		b		c		s		d		t		w				g							
				inch max.	inch min.	mm max.	mm min.	inch max.	inch min.	mm max.	mm min.	inch max.	inch min.	mm max.	mm min.	inch	mm	inch	mm	inch	mm	inch	mm	inch	mm	inch	mm
1915				.098	.090	2.50	2.30	.063	.051	1.60	1.30	4.039	4.019	102.6	102.1	.016	.40	4.36	110.7	.042	1.07	.156	3.96	.188	5.0	4.422	112.3
1916				.098	.090	2.50	2.30	.063	.051	1.60	1.30	4.236	4.216	107.6	107.1	.016	.40	4.55	115.5	.042	1.07	.156	3.96	.188	5.0	4.609	117.1
	114K			.113	.105	2.87	2.67	.118	.106	3.00	2.70	4.205	4.185	106.8	106.3	.024	.60	4.58	116.3	.095	2.41	.188	4.78	.188	5.0	4.641	117.9
		212	310	.129	.121	3.28	3.07	.118	.106	3.00	2.70	4.205	4.185	106.8	106.3	.024	.60	4.58	116.3	.095	2.41	.188	4.78	.188	5.0	4.641	117.9
1917				.113	.105	2.87	2.67	.118	.106	3.00	2.70	4.402	4.382	111.9	111.3	.024	.60	4.78	121.4	.095	2.41	.188	4.78	.188	5.0	4.844	123.0
	115K			.130	.122	3.30	3.10	.063	.051	1.60	1.30	4.630	4.610	117.6	117.1	.016	.40	4.94	125.4	.042	1.07	.156	3.96	.281	7.0	5.000	127.0
		213	311	.160	.152	4.06	3.86	.134	.122	3.40	3.10	4.536	4.516	115.2	114.7	.024	.60	5.09	129.4	.109	2.77	.281	7.14	.281	7.0	5.156	131.0
1918				.130	.122	3.30	3.10	.063	.051	1.60	1.30	4.827	4.807	122.6	122.1	.016	.40	5.14	130.6	.042	1.07	.156	3.96	.281	7.0	5.203	132.2
	116K			.113	.105	2.87	2.67	.134	.122	3.40	3.10	4.733	4.713	120.2	119.7	.024	.60	5.30	134.5	.109	2.77	.281	7.14	.281	7.0	5.359	136.1
		214		.160	.152	4.06	3.86	.134	.122	3.40	3.10	4.733	4.713	120.2	119.7	.024	.60	5.30	134.5	.109	2.77	.281	7.14	.281	7.0	5.359	136.1
1919				.130	.122	3.30	3.10	.063	.051	1.60	1.30	5.024	5.004	127.6	127.1	.016	.40	5.33	135.3	.042	1.07	.156	3.96	.281	7.0	5.391	136.9
	117K			.113	.105	2.87	2.67	.134	.122	3.40	3.10	4.930	4.910	125.2	124.7	.024	.60	5.50	139.7	.109	2.77	.281	7.14	.281	7.0	5.562	141.3
		215	312	.160	.152	4.06	3.86	.134	.122	3.40	3.10	4.930	4.910	125.2	124.7	.024	.60	5.50	139.7	.109	2.77	.281	7.14	.281	7.0	5.562	141.3
1920				.130	.122	3.30	3.10	.087	.075	2.20	1.90	5.417	5.397	137.6	137.1	.024	.60	5.73	145.7	.065	1.65	.156	3.96	.281	7.0	5.797	147.2
	118K			.146	.136	3.71	3.45	.134	.122	3.40	3.10	5.324	5.304	135.2	134.7	.024	.60	5.89	149.6	.109	2.77	.281	7.14	.281	7.0	5.953	151.2
		216	313	.193	.183	4.90	4.65	.134	.122	3.40	3.10	5.324	5.304	135.2	134.7	.024	.60	5.89	149.6	.109	2.77	.281	7.14	.281	7.0	5.953	151.2
1921				.130	.122	3.30	3.10	.087	.075	2.20	1.90	5.614	5.594	142.6	142.1	.024	.60	5.92	150.4	.065	1.65	.156	3.96	.281	7.0	5.984	152.0
	119K			.146	.136	3.71	3.45	.134	.122	3.40	3.10	5.521	5.501	140.2	139.7	.024	.60	6.08	154.4	.109	2.77	.281	7.14	.281	7.0	6.141	156.0
		217	314	.193	.183	4.90	4.65	.134	.122	3.40	3.10	5.718	5.698	145.2	144.7	.024	.60	6.28	159.5	.109	2.77	.281	7.14	.281	7.0	6.344	161.1
1922				.130	.122	3.30	3.10	.087	.075	2.20	1.90	5.811	5.791	147.6	147.1	.024	.60	6.13	155.6	.065	1.65	.156	3.96	.281	7.0	6.188	157.2
	120K			.146	.136	3.71	3.45	.134	.122	3.40	3.10	5.718	5.698	145.2	144.7	.024	.60	6.28	159.5	.109	2.77	.281	7.14	.281	7.0	6.344	161.1
		218	315	.193	.183	4.90	4.65	.134	.122	3.40	3.10	5.718	5.698	145.2	144.7	.024	.60	6.28	159.5	.109	2.77	.281	7.14	.281	7.0	6.344	161.1
1924				.146	.136	3.71	3.45	.134	.122	3.40	3.10	6.111	6.091	155.2	154.7	.024	.60	6.67	169.5	.109	2.77	.281	7.14	.281	7.0	6.734	171.0
	121K			.146	.136	3.71	3.45	.134	.122	3.40	3.10	6.111	6.091	155.2	154.7	.024	.60	6.67	169.5	.109	2.77	.281	7.14	.281	7.0	6.734	171.0
		219	316	.146	.136	3.70	3.50	.087	.075	2.20	1.90	6.370	6.350	161.8	161.3	.024	.60	6.75	171.5	.065	1.65	.188	4.78	.281	7.0	6.812	173.0
1926				.146	.136	3.70	3.50	.150	.138	3.80	3.50	6.443	6.423	163.7	163.1	.024	.60	7.19	182.6	.120	3.05	.375	9.53	.375	10.0	7.250	184.2
	122K			.146	.136	3.70	3.50	.150	.138	3.80	3.50	6.443	6.423	163.7	163.1	.024	.60	7.19	182.6	.120	3.05	.375	9.53	.375	10.0	7.250	184.2
		220	317	.146	.136	3.70	3.50	.087	.075	2.20	1.90	6.961	6.941	176.8	176.3	.024	.60	7.34	186.5	.065	1.65	.188	4.78	.375	10.0	7.406	188.0
1928				.146	.136	3.70	3.50	.150	.138	3.80	3.50	6.837	6.817	173.7	173.2	.024	.60	7.59	192.9	.120	3.05	.375	9.53	.375	10.0	7.656	194.5
	124K			.224	.214	5.69	5.44	.150	.138	3.80	3.50	6.837	6.817	173.7	173.2	.024	.60	7.59	192.9	.120	3.05	.375	9.53	.375	10.0	7.656	194.5
		222	319	.224	.214	5.69	5.44	.150	.138	3.80	3.50	7.354	7.334	186.8	186.3	.024	.60	7.73	196.5	.065	1.65	.188	4.78	.375	10.0	7.797	198.0
	126K			.224	.214	5.69	5.44	.150	.138	3.80	3.50	7.230	7.210	183.6	183.1	.024	.60	7.98	202.8	.120	3.05	.375	9.53	.375	10.0	8.047	204.4
	128K			.224	.214	5.69	5.44	.150	.138	3.80	3.50	7.624	7.604	193.7	193.1	.024	.60	8.38	212.7	.120	3.05	.375	9.53	.375	10.0	8.438	214.3
		224	320	.224	.214	5.69	5.44	.150	.138	3.80	3.50	8.018	7.998	203.7	203.2	.024	.60	8.77	222.7	.120	3.05	.375	9.53	.375	10.0	8.828	224.2
	130K			.224	.214	5.69	5.44	.150	.138	3.80	3.50	8.215	8.195	208.7	208.2	.024	.60	8.97	227.8	.120	3.05	.375	9.53	.375	10.0	9.031	229.4
		226	321	.224	.214	5.69	5.44	.150	.138	3.80	3.50	8.608	8.588	218.6	218.1	.024	.60	9.36	237.7	.120	3.05	.375	9.53	.375	10.0	9.422	239.3
		228	322	.224	.214	5.69	5.44	.150	.138	3.80	3.50	8.805	8.785	223.7	223.2	.024	.60	9.56	242.9	.120	3.05	.375	9.53	.375	10.0	9.625	244.5
	132K			.224	.214	5.69	5.44	.150	.138	3.80	3.50	9.199	9.179	233.7	233.2	.024	.60	9.95	252.8	.120	3.05	.375	9.53	.375	10.0	10.02	254.4
		230	323	.224	.214	5.69	5.44	.150	.138	3.80	3.50	9.589	9.569	243.6	243.1	.024	.60	10.3	262.7	.120	3.05	.375	9.53	.375	10.0	10.41	264.3
				.224	.214	5.69	5.44	.150	.138	3.80	3.50	10.38	10.36	263.6	263.0	.024	.60	11.1	282.6	.120	3.05	.375	9.53	.375	10.0	11.20	284.6

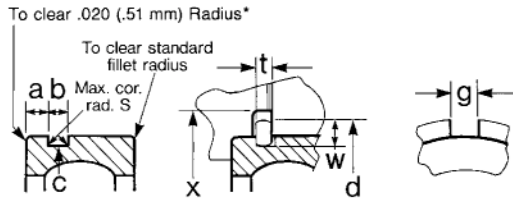

*Where standard bearing corner is .020 (.51 mm) or less, this corner remains same as standard.

Cartridge Width Bearings

Basic Bearing		Dimensions of Ring, Groove and Housing																							
200	300	Groove										Ring					Counter-bore								
		a		b		c		s		d		t		w		g		x							
		inch max.	inch min.	mm max.	mm min.	inch max.	inch min.	mm max.	mm min.	inch max.	inch min.	mm max.	mm min.	inch max.	inch min.	mm max.	mm min.	inch max.	inch min.	mm max.	mm min.	Minimum inch	Minimum mm		
203		.147	.139	3.73	3.53	.065	.053	1.65	1.35	1.500	1.490	38.1	37.9	.016	.40	1.75	44.5	.042	1.07	.125	3.18	.125	3.0	1.781	45.2
204		.187	.179	4.75	4.55	.065	.053	1.65	1.35	1.756	1.746	44.6	44.4	.016	.40	2.06	52.4	.042	1.07	.156	3.96	.125	3.0	2.094	53.2
205	304	.187	.179	4.75	4.55	.065	.053	1.65	1.35	1.958	1.948	49.7	49.5	.016	.40	2.27	57.6	.042	1.07	.156	3.96	.188	5.0	2.297	58.3
206	305	.181	.173	4.60	4.40	.087	.075	2.20	1.90	2.347	2.327	59.6	59.1	.024	.60	2.66	67.5	.065	1.65	.156	3.96	.188	5.0	2.688	68.3
207	306	.181	.173	4.60	4.40	.087	.075	2.20	1.90	2.709	2.639	68.8	68.3	.024	.60	3.08	78.2	.065	1.65	.188	4.78	.188	5.0	3.141	79.8
208	307	.181	.173	4.60	4.40	.087	.075	2.20	1.90	3.024	3.004	76.8	76.3	.024	.60	3.40	86.5	.065	1.65	.188	4.78	.188	5.0	3.469	88.1
209		.181	.173	4.60	4.40	.087	.075	2.20	1.90	3.221	3.201	81.8	81.3	.024	.60	3.59	91.3	.065	1.65	.188	4.78	.188	5.0	3.656	92.9
210	308	.179	.171	4.55	4.35	.118	.106	3.00	2.70	3.417	3.397	86.8	86.3	.024	.60	3.80	96.4	.095	2.41	.188	4.78	.188	5.0	3.859	98.0
211	309	.179	.171	4.55	4.35	.118	.106	3.00	2.70	3.811	3.791	96.8	96.3	.024	.60	4.19	106.4	.095	2.41	.188	4.78	.188	5.0	4.250	108.0
212	310	.179	.171	4.55	4.35	.118	.106	3.00	2.70	4.205	4.185	106.8	106.3	.024	.60	4.58	116.3	.095	2.41	.188	4.78	.188	5.0	4.641	117.9
213	311	.291	.283	7.39	7.19	.134	.122	3.40	3.10	4.536	4.516	115.2	114.7	.024	.60	5.09	129.4	.109	2.77	.281	7.14	.281	7.0	5.156	131.0
214		.291	.283	7.39	7.19	.134	.122	3.40	3.10	4.733	4.713	120.2	119.7	.024	.60	5.30	134.5	.109	2.77	.281	7.14	.281	7.0	5.359	136.1
215	312	.291	.283	7.39	7.19	.134	.122	3.40	3.10	4.930	4.910	125.2	124.7	.024	.60	5.50	139.7	.109	2.77	.281	7.14	.281	7.0	5.562	141.3
	313	.315	.307	8.00	7.80	.134	.122	3.40	3.10	5.324	5.304	135.2	134.7	.024	.60	5.89	149.6	.109	2.77	.281	7.14	.281	7.0	5.953	151.2
	314	.315	.307	8.00	7.80	.134	.122	3.40	3.10	5.718	5.698	145.2	144.7	.024	.60	6.28	159.5	.109	2.77	.281	7.14	.281	7.0	6.344	161.1
	315	.315	.307	8.00	7.80	.134	.122	3.40	3.10	6.111	6.091	155.2	154.7	.024	.60	6.67	169.5	.109	2.77	.281	7.14	.281	7.0	6.784	171.0

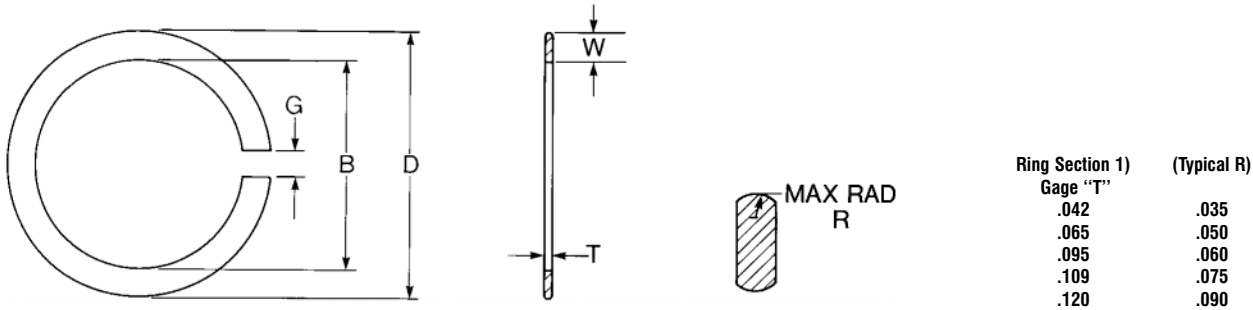

Ring Section 1) Gage "T"	(Typical R)
.042	.035
.065	.050
.095	.060
.109	.075
.120	.090

Snap Ring No.	Bearing Number				Snap Ring Dimensions						
	Extra Light (KR-KS)	Lt.	Med.	Hvy.	Brg. O.D.	Groove Dia. "C"	Bore		Thickness	Radial Thick	Radial ²⁾ Gap
							B + .000	D	"T" ± .002	W + .003	G
0		200			1.1811	1.109	1.094-.020	1.344	.042	.125	3/32 ± 1/32
1	102	201			1.2598	1.187	1.172-.020	1.422	.042	.125	3/32 ± 1/32
2	103	202	300		1.3780	1.306	1.291-.020	1.541	.042	.125	3/32 ± 1/32
2a			301		1.4567	1.369	1.354-.020	1.604	.042	.125	3/32 ± 1/32
3		203			1.5748	1.500	1.485-.020	1.735	.042	.125	3/32 ± 1/32
3a	104		302		1.6535	1.565	1.550-.020	1.800	.042	.125	3/32 ± 1/32
4	105	204	303		1.8504	1.756	1.741-.030	2.053	.042	.156	1/8 ± 1/32
5		205	304		2.0472	1.958	1.943-.030	2.255	.042	.156	1/8 ± 1/32
5a	106				2.1654	2.071	2.056-.030	2.368	.042	.156	1/8 ± 1/32
6	107	206	305	403	2.4409	2.347	2.322-.030	2.634	.065	.156	1/8 ± 1/32
6b	108				2.6772	2.616	2.591-.030	2.922	.065	.156	1/8 ± 1/32
7		207	306	404	2.8346	2.709	2.684-.030	3.060	.065	.188	1/8 ± 1/32
7a	109				2.9528	2.828	2.803-.030	3.179	.065	.188	1/8 ± 1/32
8	110	208	307	405	3.1496	3.024	2.999-.046	3.375	.065	.188	5/32 ± 3/64
9		209			3.3465	3.221	3.196-.046	3.572	.065	.188	5/32 ± 3/64
10	111	210	308	406	3.5433	3.417	3.392-.046	3.768	.095	.188	5/32 ± 3/64
10a	112				3.7402	3.615	3.590-.046	3.966	.095	.188	5/32 ± 3/64
11	113	211	309	407	3.9370	3.811	3.786-.046	4.162	.095	.188	5/32 ± 3/64
12	114	212	310	408	4.3307	4.205	4.180-.062	4.556	.095	.188	3/16 ± 1/16
12a	115				4.5276	4.402	4.377-.062	4.753	.095	.188	3/16 ± 1/16
13		213	311	409	4.7244	4.536	4.506-.062	5.068	.109	.281	3/16 ± 1/16
14	116	214			4.9213	4.733	4.703-.062	5.265	.109	.281	3/16 ± 1/16
15	117	215	312	410	5.1181	4.930	4.900-.062	5.462	.109	.281	3/16 ± 1/16
16	118	216	313	411	5.5118	5.324	5.294-.093	5.856	.109	.281	9/32 ± 1/16
16a	119				5.7087	5.521	5.491-.093	6.053	.109	.281	9/32 ± 1/16
17	120	217	314	412	5.9055	5.718	5.688-.093	6.250	.109	.281	9/32 ± 1/16
18	121	218	315	413	6.2992	6.111	6.081-.093	6.643	.109	.281	9/32 ± 1/16
19	122	219	316		6.6929	6.443	6.413-.125	7.163	.120	.375	3/8 ± 1/16
20	124	220	317	414	7.0866	6.837	6.807-.125	7.557	.120	.375	3/8 ± 1/16
21		221	318	415	7.4803	7.230	7.200-.125	7.950	.120	.375	3/8 ± 1/16
22	126	222	319	416	7.8740	7.624	7.594-.125	8.344	.120	.375	3/8 ± 1/16
23	128			417	8.2677	8.018	7.987-.125	8.737	.120	.375	3/8 ± 1/16
24		224	320		8.4646	8.215	8.184-.125	8.934	.120	.375	3/8 ± 1/16
25	130		321	418	8.8583	8.608	8.578-.156	9.328	.120	.375	15/32 ± 3/32
26		226			9.0551	8.805	8.775-.156	9.525	.120	.375	15/32 ± 3/32
27	132		322		9.4488	9.199	9.168-.156	9.918	.120	.375	15/32 ± 3/32

¹⁾ Snap-ring need not conform to cross section shown but all 4 corners must clear .016 max. fillet (snap rings 0 thru 5a) or .024 (snap rings 6 thru 27).

²⁾ Gap dimension and tolerance apply when snap ring bore "B" is nominal diameter shown (max. bore).

Break all sharp corners and remove all burrs.

Bearing Accessories

Locknuts, Lockwashers and Lockplates

Locknuts and lockwashers are commonly used as effective means for holding bearing inner rings axially on the shaft. They are also frequently used to secure gears, belt pulleys and other machine components. The locknuts are accurately made to insure that the abutment face will be square with the shaft axis, thus avoiding distortion of the shaft during tightening.

The lockwashers are made from selected high quality steel, heat treated, and they must pass a final inspection that requires their finish to be smooth and free from burrs.

The lockplate is a steel stamping that engages the slot of the sleeve and is secured to the end face of larger nuts by two screws. This unit is used in place of lockwashers.

Wherever bearings must be held in permanent or correct position, use locknuts, lockwashers and lockplates.

Removable Sleeves and Removal Nuts

Removable sleeves have a taper on the outside diameter corresponding to the taper in the bore of the bearings. These sleeves are used for applications where bearings must be removed occasionally for the inspection of machine parts and at the same time will be positively located on the shaft with the equivalent of a press fit. A removal nut is used to remove the sleeve from the bearing. In assembling, the sleeve is locked on a threaded shaft by means of locknuts, lockwashers and lockplates.

Adapters

The adapter is used to hold and locate a tapered bore bearing on a cylindrical seat. It permits relatively wide tolerances for the shaft diameter and makes it unnecessary to heat the bearing or use a press when mounting in order to obtain an interference fit of the inner race on the shaft. Adapters are manufactured with the same precise techniques and care used in the manufacture of bearings.

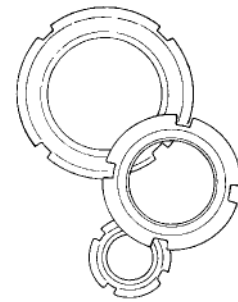

Locknuts

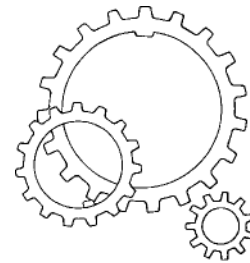

Lockwashers

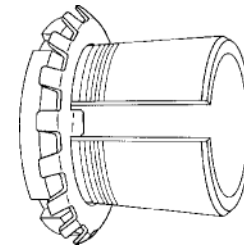

Adapters

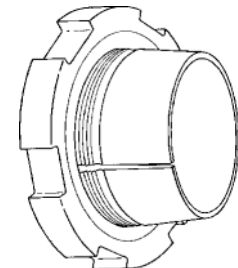

Removable Sleeves and Removable Nuts

Locknuts & Lockwashers for Ball Bearings ABMA Standards

MRC Bearing Services

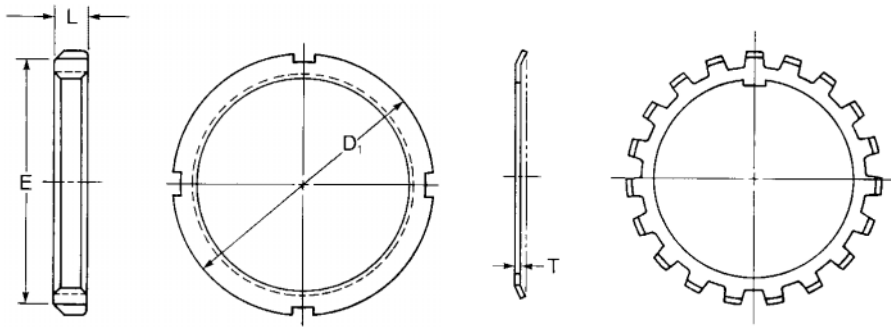

Lock Nut No.	Nominal Bearing Bore Dia.		Locknut										Lockwasher		
			Outside Diameter D ₁		Thickness L				Face Diameter E				Lock Washer No.	Thickness T	
			+ .13 - .38 mm	+ .005 - .015 in	Min.		Max.		Min.		Max.			mm	in
					mm	in	mm	in	mm	in	mm	in			
N00	10	.3937	19.0	3/4	5.31	.209	5.81	.229	15.4	.605	15.9	.625	W00	1.07	.042
N01	12	.4724	22.2	7/8	7.70	.303	8.20	.323	17.8	.699	18.3	.719	W01	1.07	.042
N02	15	.5906	25.4	1	7.70	.303	8.20	.323	20.1	.793	20.7	.813	W02	1.07	.042
N03	17	.6693	28.6	1 1/8	8.48	.334	8.99	.354	23.3	.918	23.8	.938	W03	1.07	.042
N04	20	.7874	34.9	1 1/4	9.27	.365	9.78	.385	28.1	1.105	28.6	1.125	W04	1.07	.042
N05	25	.9843	39.7	1 1/2	10.1	.396	10.6	.416	32.0	1.261	32.5	1.281	W05	1.27	.050
N06	30	1.1811	44.4	1 3/4	10.1	.396	10.6	.416	37.6	1.480	38.1	1.500	W06	1.27	.050
N07	35	1.3780	52.4	2 1/4	10.9	.428	11.4	.448	45.5	1.793	46.1	1.813	W07	1.27	.050
N08	40	1.5748	57.2	2 1/2	10.9	.428	11.4	.448	50.3	1.980	50.8	2.000	W08	1.47	.058
N09	45	1.7717	64.3	2 7/8	10.9	.428	11.4	.448	57.4	2.261	57.9	2.281	W09	1.47	.058
N10	50	1.9685	68.3	2 15/16	12.4	.490	13.0	.510	61.4	2.418	61.9	2.438	W10	1.47	.058
N11	55	2.1654	75.4	2 31/32	12.4	.490	13.0	.510	67.0	2.636	67.5	2.656	W11	1.60	.063
N12	60	2.3622	80.2	3 1/2	13.2	.521	13.7	.541	71.7	2.824	72.2	2.844	W12	1.60	.063
N13	65	2.5591	85.7	3 3/8	14.0	.553	14.6	.573	77.3	3.043	77.8	3.063	W13	1.60	.063
N14	70	2.7559	92.1	3 5/8	14.0	.553	14.6	.573	83.4	3.283	84.2	3.313	W14	1.60	.063
AN15	75	2.9528	98.4	3 7/8	14.8	.584	15.3	.604	89.7	3.533	90.5	3.563	W15	1.83	.072
AN16	80	3.1496	105.6	4 1/2	14.8	.584	15.3	.604	96.9	3.814	97.6	3.844	W16	1.83	.072
AN17	85	3.3465	111.9	4 3/4	15.6	.615	16.1	.635	101.6	4.001	102.4	4.031	W17	1.83	.072
AN18	90	3.5433	118.3	4 7/8	17.2	.678	17.7	.698	108.0	4.251	108.7	4.281	W18	2.39	.094
AN19	95	3.7402	125.4	4 15/16	18.0	.709	18.5	.729	115.1	4.533	115.9	4.563	W19	2.39	.094
AN20	100	3.9370	131.8	5 1/16	18.7	.735	19.3	.760	121.5	4.783	122.3	4.813	W20	2.39	.094
AN21	105	4.1339	138.1	5 7/16	18.7	.735	19.3	.760	126.2	4.970	127.0	5.000	W21	2.39	.094
AN22	110	4.3307	145.3	5 23/32	19.5	.766	20.1	.791	133.4	5.251	134.1	5.281	W22	3.18	.125
AN24	120	4.7244	155.6	6 1/8	20.3	.798	20.9	.823	143.7	5.658	144.5	5.688	W24	3.18	.125
AN26	130	5.1181	171.4	6 3/4	21.8	.860	22.5	.885	156.4	6.158	157.2	6.188	W26	3.18	.125
AN28	140	5.5118	180.2	7 1/2	23.4	.923	24.1	.948	165.1	6.501	165.9	6.531	W28	3.18	.125
AN30	150	5.9055	195.3	7 15/16	24.2	.954	24.9	.979	178.6	7.033	179.4	7.063	W30	3.96	.156
AN32	160	6.2992	204.8	8 1/16	25.8	1.016	26.4	1.041	187.9	7.398	188.9	7.438	W32	3.96	.156
AN34	170	6.6929	219.9	8 21/32	26.6	1.048	27.3	1.073	203.0	7.991	204.0	8.031	W34	3.96	.156
AN36	180	7.0866	230.2	9 1/16	27.4	1.079	28.0	1.104	211.7	8.335	212.7	8.375	W36	3.96	.156
AN38	190	7.4803	240.5	9 15/32	28.2	1.110	28.8	1.135	222.0	8.741	223.0	8.781	W38	3.96	.156
AN40	200	7.8740	250.0	9 27/32	29.8	1.173	30.4	1.198	231.5	9.116	232.6	9.156	W40	3.96	.156
N44	220	8.6614	279.4	11	31.2	1.230	32.0	1.260	249.0	9.803	250.0	9.843	W44	3.96	.156

Threads—American (National) Standard Form, Fine Pitch Class 3 Fit

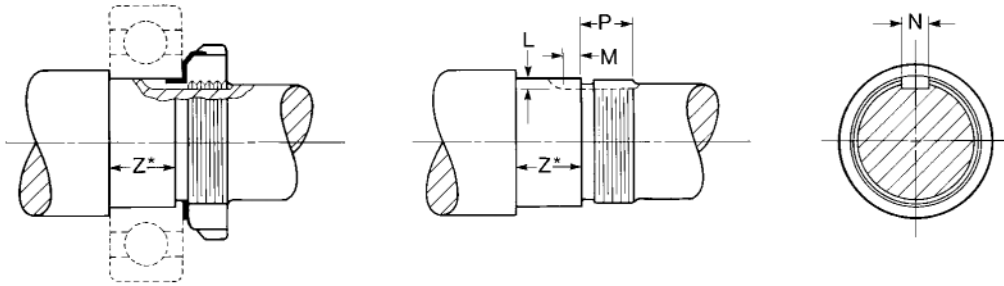

Lock Nut No.	Threads Per Inch	Dimensions of Shaft Threads										Keyway					
		Major Diameter				Pitch Diameter				Length P		Full Length L		Full Depth Length M		Width N	
		Max. mm	Min. in	Max. mm	Min. in	Max. mm	Min. in	Max. mm	Min. in	+ .40 -0 mm	+ 1/64 -0 in	+ .40 -0 mm	+ 1/64 -0 in	+ .40 -0 mm	+ 1/64 -0 in	+ .40 -0 mm	+ 1/64 -0 in
N00	32	9.93	.391	9.794	.3856	9.416	.3707	9.350	.3681	7.1	9/32	1.6	1/16	2.4	3/32	3.2	1/8
N01	32	11.91	.469	11.775	.4636	11.397	.4487	11.331	.4461	9.5	3/8	1.6	1/16	2.4	3/32	3.2	1/8
N02	32	14.88	.586	14.747	.5806	14.369	.5657	14.293	.5627	9.5	3/8	2.0	5/64	2.4	3/32	3.2	1/8
N03	32	16.87	.664	16.728	.6586	16.350	.6437	16.274	.6407	10.3	13/32	2.0	5/64	2.4	3/32	3.2	1/8
N04	32	19.84	.781	19.700	.7756	19.322	.7607	19.235	.7573	11.1	7/16	2.0	5/64	2.4	3/32	4.8	3/16
N05	32	24.61	.969	24.475	.9636	24.097	.9487	24.011	.9453	11.9	15/32	2.4	3/32	3.2	1/8	4.8	3/16
N06	18	29.79	1.173	29.586	1.1643	28.877	1.1369	28.776	1.1329	11.9	15/32	2.4	3/32	3.2	1/8	4.8	3/16
N07	18	34.95	1.376	34.742	1.3678	34.034	1.3399	33.932	1.3359	12.7	1/2	2.4	3/32	3.2	1/8	4.8	3/16
N08	18	39.70	1.563	39.492	1.5548	38.783	1.5269	38.669	1.5224	13.5	17/32	2.4	3/32	3.2	1/8	7.9	5/16
N09	18	44.88	1.767	44.674	1.7588	43.965	1.7309	43.851	1.7264	13.5	17/32	2.4	3/32	4.0	5/32	7.9	5/16
N10	18	49.96	1.967	49.754	1.9588	49.045	1.9309	48.931	1.9264	15.1	19/32	2.4	3/32	4.0	5/32	7.9	5/16
N11	18	54.79	2.157	54.580	2.1488	53.871	2.1209	53.741	2.1158	15.1	19/32	3.2	1/8	4.0	5/32	7.9	5/16
N12	18	59.94	2.360	59.736	2.3518	59.027	2.3239	58.898	2.3188	15.9	5/8	3.2	1/8	4.0	5/32	7.9	5/16
N13	18	64.72	2.548	64.511	2.5398	63.802	2.5119	63.673	2.5068	16.7	21/32	3.2	1/8	4.0	5/32	7.9	5/16
N14	18	69.88	2.751	69.667	2.7428	68.959	2.7149	68.829	2.7098	16.7	21/32	3.2	1/8	6.4	1/4	7.9	5/16
AN15	12	74.50	2.933	74.214	2.9218	73.124	2.8789	72.987	2.8735	17.5	11/16	3.2	1/8	6.4	1/4	7.9	5/16
AN16	12	79.68	3.137	79.395	3.1258	78.306	3.0829	78.156	3.0770	17.5	11/16	3.2	1/8	6.4	1/4	9.5	3/8
AN17	12	84.84	3.340	84.552	3.3288	83.462	3.2859	83.274	3.2785	18.3	23/32	3.2	1/8	6.4	1/4	9.5	3/8
AN18	12	89.59	3.527	89.301	3.5153	88.212	3.4729	88.024	3.4655	20.6	13/16	4.0	5/32	6.4	1/4	9.5	3/8
AN19	12	94.74	3.730	94.458	3.7188	93.368	3.6759	93.180	3.6685	21.4	27/32	4.0	5/32	6.4	1/4	9.5	3/8
AN20	12	99.52	3.918	99.233	3.9068	98.143	3.8639	97.955	3.8565	22.2	7/8	4.0	5/32	7.9	5/16	9.5	3/8
AN21	12	104.70	4.122	104.415	4.1108	103.325	4.0679	103.114	4.0596	22.2	7/8	4.0	5/32	7.9	5/16	9.5	3/8
AN22	12	109.86	4.325	109.571	4.3138	108.481	4.2709	108.270	4.2626	23.0	29/32	4.8	3/16	7.9	5/16	9.5	3/8
AN24	12	119.79	4.716	119.502	4.7048	118.412	4.6619	118.202	4.6536	23.8	15/16	4.8	3/16	7.9	5/16	9.5	3/8
AN26	12	129.69	5.106	129.408	5.0948	128.319	5.0519	128.108	5.0436	25.4	1	4.8	3/16	7.9	5/16	12.7	1/2
AN28	12	139.62	5.497	139.340	5.4858	138.250	5.4429	138.039	5.4346	27.0	1 1/16	4.8	3/16	7.9	5/16	15.9	5/8
AN30	12	149.56	5.888	149.271	5.8768	148.181	5.8339	147.971	5.8256	28.6	1 1/8	5.6	7/32	9.5	3/8	15.9	5/8
AN32	8	159.61	6.284	159.228	6.2638	157.551	6.2028	157.320	6.1937	30.2	1 3/16	6.0	15/64	9.5	3/8	15.9	5/8
AN34	8	169.14	6.659	168.753	6.6438	167.076	6.5778	166.845	6.5687	31.0	1 7/32	6.0	15/64	9.5	3/8	19.1	3/4
AN36	8	179.48	7.066	179.091	7.0508	177.414	6.9848	177.183	6.9757	31.8	1 1/4	6.0	15/64	9.5	3/8	19.1	3/4
AN38	8	189.79	7.472	189.403	7.4568	187.727	7.3908	187.496	7.3817	32.5	1 9/32	6.0	15/64	9.5	3/8	19.1	3/4
AN40	8	199.31	7.847	198.928	7.8318	197.252	7.7658	196.962	7.7544	34.1	1 11/32	6.0	15/64	9.5	3/8	22.2	7/8
N44	8	219.15	8.628	218.766	8.6128	217.089	8.5468	216.782	8.5347	34.9	1 3/8	9.5	3/8	4.8	3/16	27.0	1 1/16

*Z = Minimum bearing width - .016 ± .010 in
- .406 ± .254mm

Locknut torques are standardized regardless of the type of locknut used. Acceptable locknut torques for dry thread engagement are shown in the following table. Bearing locknuts shall be tightened using a torque wrench and a two-point locknut wrench or other suitable torque wrench adapter.

Bearing Bore (mm)	Locknut Torque (ft-lb)	Approximate Clamping Force (lb)
10	10-20	1 620-3 240
12	10-20	1 340-2 680
15	10-20	1 070-2 140
17	10-20	940-1 880
20	12-35	950-2 770
25	23-50	1 450-3 170
30	32-60	1 690-3 170
35	39-70	1 750-3 140
40	50-80	1 970-3 140
45	64-90	2 220-3 120
50	67-100	2 090-3 120
55	82-125	2 330-3 540
60	99-150	2 560-3 880
65	131-175	3 130-4 190
70	152-200	3 360-4 430
75	173-250	3 610-5 220
80	197-275	3 840-5 350
85	222-325	4 060-5 940
90	248-375	4 280-6 480
95	277-425	4 520-6 950
100	345-475	5 360-7 380
105	380-550	5 620-8 120
110	380-550	5 340-7 740
120	380-550	4 900-7 080
130	380-550	4 510-6 540
140	380-550	4 190-6 070
150	380-550	3 910-5 660
160	380-550	3 680-5 330

For the precision ball and roller bearings supplied by MRC Bearings, skill and cleanliness while handling, mounting and dismounting are necessary to ensure satisfactory bearing performance. As precision components, rolling bearings must be handled with appropriate care during transportation, storage, mounting and dismounting. For example, it is well known that minute dents, and small amounts of contact surface corrosion and contaminants will seriously shorten bearing endurance.

Such damages can be caused by improper handling.

Bearing Storage and Transportation

Before packaging, MRC precision bearings are treated with a high-grade preservative and they should be stored in the original, unbroken package. **The relative humidity in the storage room should not exceed 60%.** When transporting bearings into and out of the storage room, care must be exercised not to drop the bearings nor apply heavy or even moderate impact loading of any kind to prevent damage to, or dislodging of, any of the bearing components. Also care must be exercised to assure the package remains unbroken to prevent contaminants from being introduced into the bearings.

Preparations for Bearing Mounting

Mounting should be carried out in a dry, dust free room away from metal-working or other machines producing swarf and dust and operating with contaminating agents. Before mounting the bearings, all the necessary parts, tools and equipment should be at hand. It is also important that any drawings or instructions be studied to determine the correct order in which the various components are to be mounted.

All components of the bearing arrangement (housings, shafts, etc.) must be carefully cleaned and any burrs removed; unmachined internal surfaces of cast housings must be free of core grit. The dimensional and form accuracy of all components in contact with the bearings must be checked. The bearings will only perform satisfactorily if the prescribed tolerances of the mounting structures are adhered to. The bearings should be left in their original packages until immediately before mounting.

There is usually no need to remove preservative protecting the bearings. If, however, the bearings are to be grease-lubricated and used at very high or very low temperatures, or when the grease has been determined to be incompatible with the preservative, it is necessary to wash the bearings in a suitable, non-contaminated fluid and carefully dry the bearings prior to mounting. This is to prevent any detrimental effect on the lubricating properties of the grease.

Bearings which have become contaminated because of improper handling (damaged package, etc.) must be carefully washed and dried before mounting.

Bearings which are supplied ready-greased and which have seals, shields or polymerized lubricant must never be washed before mounting.

Bearing Mounting

The method (mechanical, hydraulic or thermal) used to mount a bearing depends on the type and size of the bearing and complexity of the application assembly.

In all cases, it is extremely important that neither the bearing, nor any of its components (rings, cage or rolling elements), receive any impact loading (hammer blows, etc.) as this would damage the bearing and could dislodge components. Also, under no circumstances must pressure be applied to one ring in order to mount the other ring.

With non-separable bearings, the ring which is to have the tighter fit is generally mounted first. The seating surface should be lightly oiled before mounting. Pressure may be uniformly applied against a sleeve abutting the bearing ring face; the use of a mounting dolly instead of a sleeve, as shown in Figure 1, permits a mounting force to be applied centrally.

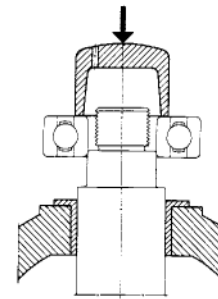

Figure 1

If a non-separable bearing is to be pressed onto the shaft and into the housing simultaneously, the tool set shown by Figure 2, in which a mounting ring is inserted between the dolly and the bearing to simultaneously abut the side faces of the inner and outer rings, may be used. For the mounting forces to be applied equally to both rings, the abutment surfaces of the mounting ring must lie in the same plane.

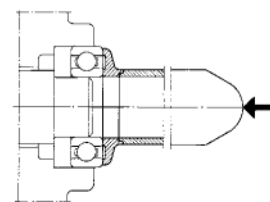

Figure 2

Bearing Mounting

Most split inner ring ball bearings, cylindrical roller bearings and tapered roller bearings are designed as separable bearings. In the case of split inner ring ball bearings and cylindrical roller bearings, this means that the outer ring, cage and rolling elements comprise a non-separable unit when the inner ring is removed. Sometimes the inner ring, cage and rolling elements comprise the non-separable unit; this is usually the case for tapered roller bearings.

With separable bearings, the inner ring can be mounted independently of the outer ring. This simplifies mounting, particularly where each ring is to have an interference fit. When inserting the shaft, with the inner ring already mounted, into the housing containing the outer ring, care must be taken that the shaft is correctly aligned with the housing to prevent scoring the raceways and damaging the rolling elements.

For a cylindrical roller bearing, should either part of the bearing be mounted askew, damage may easily be caused to the rings or rollers especially if the rollers and raceways are not oiled or if the parts are rotated during fitting.

It is generally not possible to mount larger bearings in the cold state, as the force required to mount a bearing increases very considerably with bearing size. The bearings, the inner rings or the housings are heated prior to mounting. The required difference in temperature between the bearing ring and shaft or housing depends on the degree of interference and the diameter of the bearing seating. Guideline values for the temperature differences required for some of the most commonly employed fits of bearings may be found in the accompanying diagram (Figure 3).

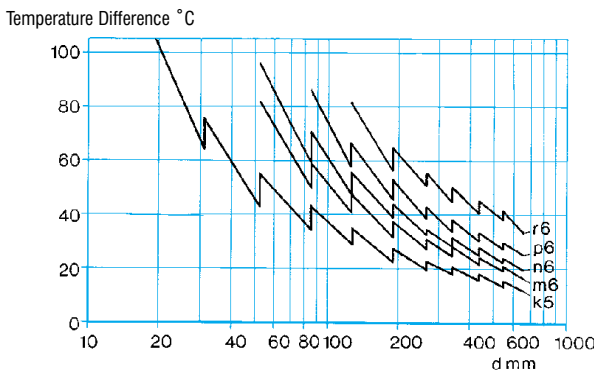

Figure 3

Bearings fabricated from AISI 52100 steel, or other steels suitable for normal operating temperatures (for example, 150°C [300°F]) should not be heated to more than 125°C [250°F] since dimensional changes caused by alterations in the material structure may occur.

Bearings fabricated from steels capable of operation at higher temperatures may be heated to somewhat higher temperatures; e.g., 205°C [400°F] for mounting purposes. The indicated temperature is more dictated by the preserving lubricant temperature limit than by the steel. Ready-greased bearings fitted with seals and/or shields should not be heated.

Local overheating must be avoided when heating bearings. Uniform, risk-free heating can be achieved using electric heaters, heating cabinets and oil baths. If hotplates are used, the bearing must be turned over a number of times. The inner rings of medium and large cylindrical roller bearings which have no flange or an integral flange on one side only may be heated using an induction heating tool or heating ring.

Bearing Adjustment

The internal clearance of single row, angular contact ball bearings is only established, in contrast to other radial bearings, when one bearing is adjusted against a second bearing. Usually these bearings are arranged in face-to-face or back-to-back pairs, and one bearing ring is axially displaced until a given clearance or preload is attained (Figure 4).

Bearings are placed so that the unmarked (low shoulder side) of the outer rings are together. Contact angle lines of two bearings converge inwardly toward the bore of the bearing.

Bearings are placed so that the marked backs (high shoulder side) of the outer rings are together. Contact angle lines of the bearings converge outwardly, away from the bearing bores.

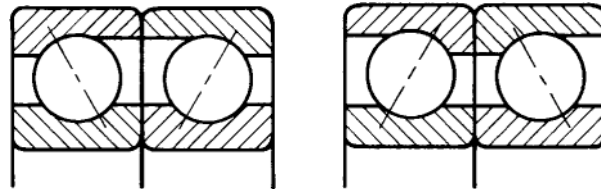

Figure 4 Angular contact ball bearings pair mounting arrangements.

The appropriate value for the clearance to be obtained when mounting is determined by the conditions when the bearing is under load and at the operating temperature. Depending on the size and arrangement of the bearings, the materials from which the shaft and housing are fabricated and the distance between the two bearings, the initial clearance obtained on mounting may be smaller or larger in actual operation. If, for example, differential thermal expansion will cause a reduction in clearance, the initial clearance must be sufficiently large so that distortion of the bearings and resultant detrimental effects are avoided.

Since there is a definite relationship between radial and axial internal clearance of angular contact ball bearings, it is sufficient to specify a single value, generally the axial internal clearance. This specified value is then obtained, starting from a condition of zero clearance, by loosening or tightening a nut on the shaft or a threaded ring in the housing bore, or by inserting calibrated shims between one of the bearing rings and its abutment. The actual methods used to adjust the clearance and measure the set clearance are determined by whether a few or many bearings are to be mounted.

Dismounting of Bearings

If bearings are to be reused after removal from the application, the force used to dismount them must never be applied through the rolling elements. With separable bearings, the ring with the rolling element and cage assembly can be removed independently of the other ring. With non-separable bearings, the ring having the looser fit should be removed from its seating first. To dismount a bearing ring having an interference fit, the tools and accessories described in the following may be used depending on bearing type and size.

Bearing Ring Puller

Small bearings may be removed from their seatings by using a puller as illustrated in Figure 5.

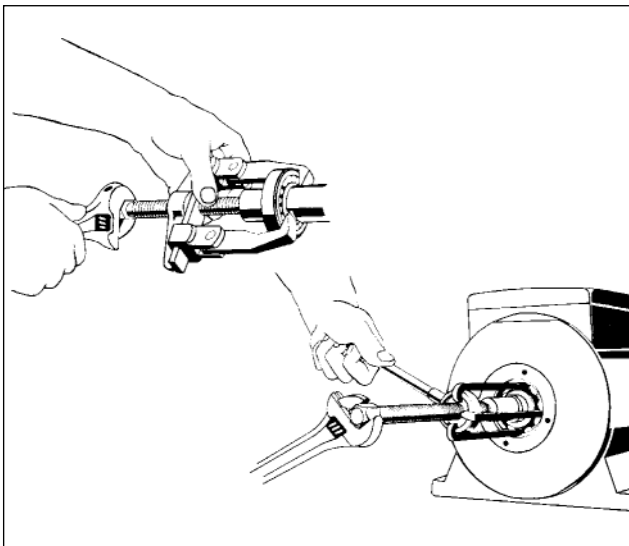
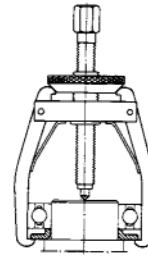
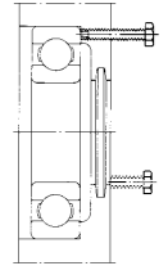

Figure 5

The claws of the puller should be placed against the side face of the ring to be removed or an adjacent component; e.g., a labyrinth ring, etc. Dismounting is made easier if, when designing the bearing arrangement, slots are provided in the shaft and housing shoulders to accommodate the claws of the puller. Outer rings can be removed more easily from their housings if tapped holes are provided in the shoulders to take withdrawal screws (Figure 6).



Puller acting on labyrinth ring



Housing with tapped holes for withdrawal screws

Figure 6

**Typical Horizontal Mountings
For Single-Row
Radial and Double-Row Bearings**

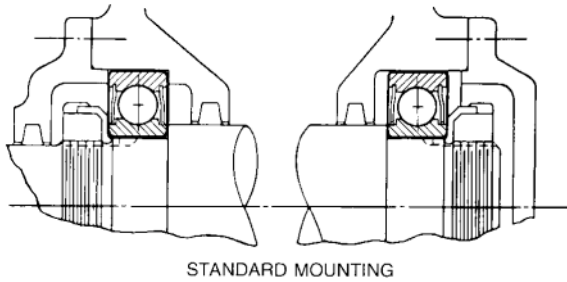

This is the ideal mounting for a shaft supported by two ball bearings, and has these advantages:

1. It permits one bearing to take thrust in either direction.
2. Axial shaft expansion is provided for by the "floating" of the unclamped bearing.
3. The bearings cannot be axially preloaded through improper adjustment of the lock nuts. The lock nuts serve to clamp the bearing inner rings against the shaft shoulder.
4. This mounting arrangement is suitable for a wide range of speed and temperature conditions.

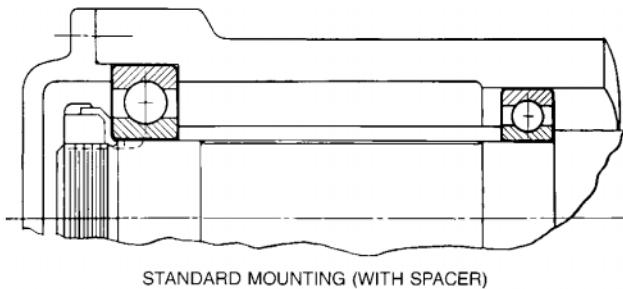

This is an alternate mounting with that shown above, and should be used where the bearings are assembled from one end of the shaft. Note that the inner rings of both bearings, together with the spacer which separates them, are clamped against the shaft shoulder by means of one lock nut at the end of the shaft. (Compare mounting above which requires two lock nuts.) This construction has the same advantages as those enumerated above.

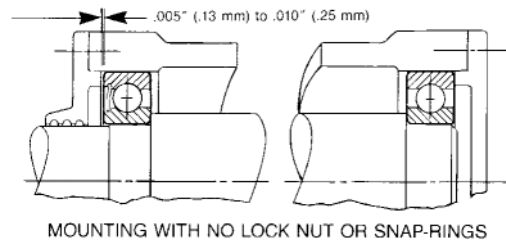

MOUNTING WITH NO LOCK NUT OR SNAP-RINGS

The mounting shown above employs no lock nuts on the shaft and permits through bore in the housing. Due to tolerance build-up of the various components, it is difficult to control the axial play of the shaft unless shims are used. These shims are usually mounted between the face of the bearing outer ring and the end cover shoulder. Axial play of the shaft should be sufficiently large to eliminate any possibility of preloading due to thermal expansions, yet small enough to eliminate excessive chucking under reversing thrust load.

This means of mounting may be effectively employed where there is no rapid alternation in the direction of the thrust load. It is also adaptable for locations where shaft length is short.

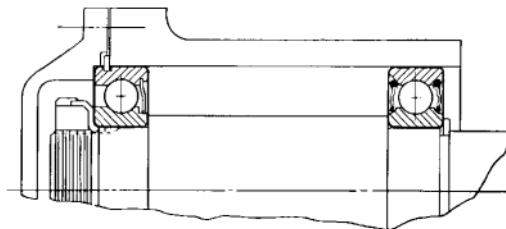

MOUNTING WITH LOCK NUT AND SNAP-RING

This type of mounting differs from that shown in the top sketch on the opposite page in that the bearing on the right end is held on the shaft by a snap-ring which eliminates the lock nut and the necessity of threading the shaft. Use of a snap-ring bearing (as shown on the left) makes use of a through bore housing possible, thereby allowing economies in manufacture.

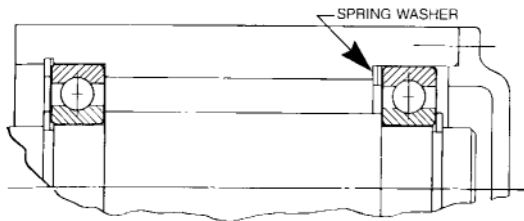

MOUNTING WITH SNAP-RINGS AND SPRING WASHER

The above mounting can be used where both shaft and housing have shoulders, and where thrust is not excessive. The commercially available spring washer provides a small preload to the bearings. This eliminates shaft end play and enhances quiet bearing operation.

Pair of Angular-Contact bearings mounted opposed to take thrust in either direction.

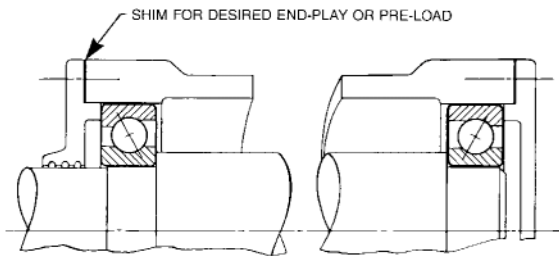

This construction requires a shoulder on the shaft, and a clamping member of the outer ring, with shim adjustment.

Lock nuts on the shaft can in general be dispensed with, but should be used where the inner ring must be very firmly secured to resist shock or vibratory loads.

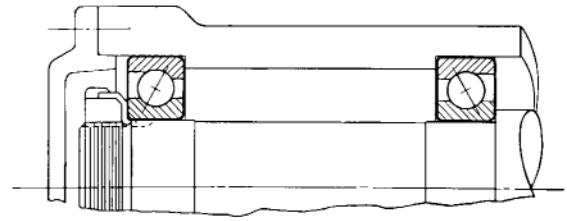

This construction requires housing shoulders, and a lock nut on the shaft. Adjustment is made by means of the lock nut. The left hand bearing should have a sliding fit on the shaft.

Owing to the difficulty of accurate adjustment and danger of excessive tightening, this mounting is not often recommended.

If the thrust in one direction is substantially less than in the opposite direction, the bearings can be of different sizes so as to give approximately equal safety factors. Also the reverse thrust can, if desired, be taken care of by a smaller angular-contact bearing, or by a radial bearing.

**Typical Vertical Mountings
For Angular-Contact Bearings**

Vertical mountings are frequently used with oil lubrication. This requires a means for lifting the oil into contact with the bearings. The sketches below show three approved mounting arrangements.

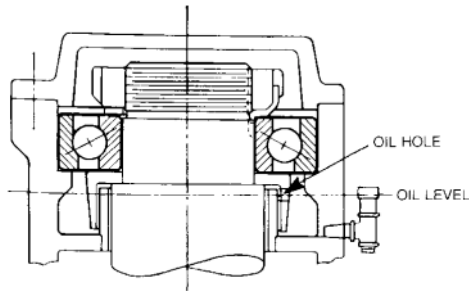

The design above is suited for uni-directional thrust. If reversing thrust is present, it must be taken by an opposed bearing mounted at the bottom of the shaft. Note that the oil is lifted into the bearing by means of the inverted rotating cone. Attention is called to the drilled hole which prevents possible siphoning out of the oil when the shaft is stationary.

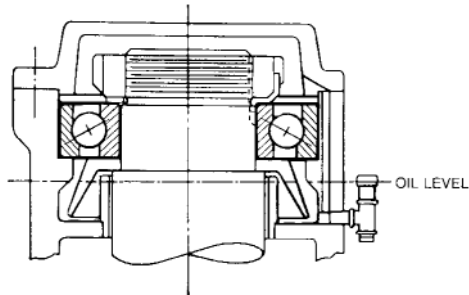

The sketch above shows the conventional method of circulating oil in a vertical application. Note that the dish-shaped oil thrower pumps the oil up through the drilled hole in the housing from which the oil flows downward through the bearing by gravity. Reverse thrust loads must be carried by an opposed bearing.

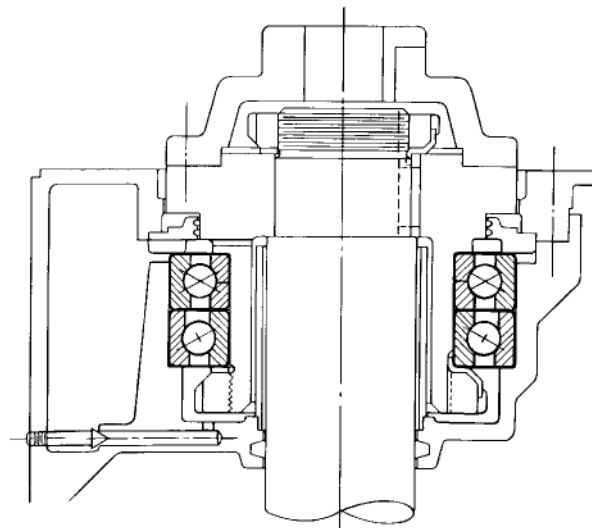

Application of MRC 97000 Series

The bearing arrangement above is capable of supporting extremely heavy thrust in the downward direction as well as substantially heavy thrust loads in the upward direction. The radial support bearing at the bottom of the shaft need not be shimmed to carry the up-thrust. The 9000-UD bearing may be mounted above (as shown) or below, the 7000-D, but maintaining the same orientation of bearing faces.

In the lubricating arrangement shown, the bearings serve as a pump to elevate the oil from the chamber immediately below the bearings to a passageway at the top of the bearings. From this point the oil returns by gravity to the reservoir shown at the left. Oil flow into the chamber below the bearings is adjusted by means of a metering pin. This system has a unique advantage in that the bearings may be completely covered by the oil level during shut-down, thereby protecting them against damage through corrosion.

Typical Methods of Mounting Bearings For High Speed Operation

The drawings here illustrate proven designs for high speed service, primarily for machine tool spindles. Note the rugged sections for minimizing deflection and the labyrinth flinger seals for protecting the bearings against the entrance of foreign material. Additional sealing protection is often provided by introducing air-oil mist in the chamber between the two bearings. This not only lubricates the bearings, but also assures a positive outward flow of air through the labyrinth passage. The radial clearances in the labyrinth should be .005" (.13mm) to .010" (.25mm) and the axial clearances should be approximately $\frac{1}{32}$ " (.080mm) to $\frac{1}{16}$ " (1.59mm).

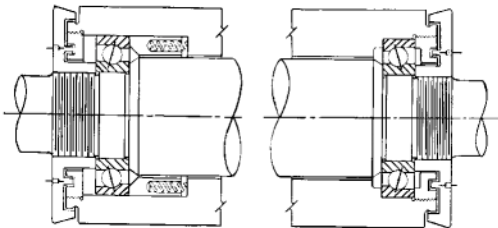

This is the simplest high speed mounting arrangement and is used for a wide variety of applications involving extremely high speeds. The spring pack bears against the face of the outer ring on the bearing at the left in order to preload the two bearings. Bearing on left end of shaft must be free to float in housing for preload to be effective. For extremely high speeds, the floating bearing is sometimes mounted in a cartridge in order to improve the length-to-diameter ratio of the sliding member.

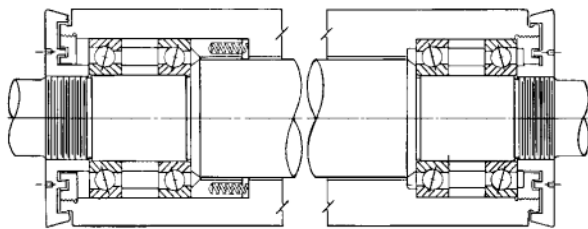

In this arrangement, the duplex tandem pair on the left end of the shaft is spring preloaded against another duplex tandem pair on the right. The pairs at either end are separated by equal length spacers between bearing outer rings and inner rings. This arrangement produces good shaft rigidity due to the multiple shaft support.

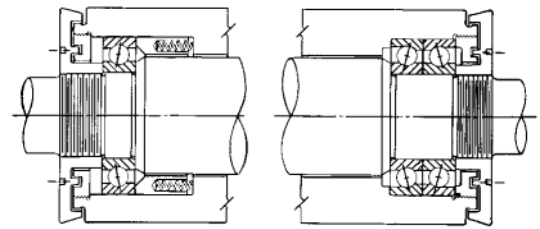

In this arrangement the shaft is supported at the right end by a duplex pair mounted in the back-to-back relationship. These bearings may be supplied as a preloaded set if operating conditions require that deflections be minimized. The bearing on the left end of the shaft is a single-row deep-groove bearing which floats axially in the housing and is lightly spring loaded to remove residual clearances.

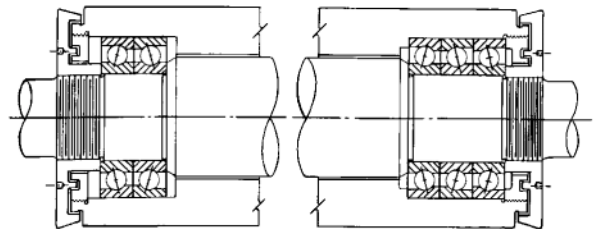

The shaft is located axially by the arrangement on the right end of the shaft which consists of a pair of tandem bearings opposed back-to-back against a single bearing. The duplex back-to-back pair on the left end of the shaft is free to move axially in the housing. This mounting arrangement has great rigidity.

Shaft and Housing Shoulder Diameters

MRC Bearing Services

Shoulder Diameters for Millimeter and Inch-size MRC Ball Bearings

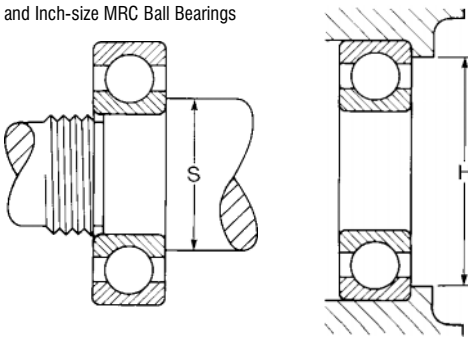

The tables on these pages show minimum shaft shoulder diameters and maximum housing shoulder diameters as established by the MRC Technical Services Department. However, the user may wish to modify these diameters to meet specific requirements such as assembly or disassembly problems or extremely heavy thrust loads. Please consult the MRC Technical Services Department for specific recommendations concerning your requirements.

MRC Bearing Number	S Min.		H Max.	
	mm	in	mm	in
	34	5.51	.22	14.2
35	6.61	.26	17.0	.67
36	7.61	.30	17.0	.67
37	8.61	.34	20.0	.79
38	9.71	.38	20.0	.79
39	11.4	.45	23.4	.92
R2	4.6	.179	8.3	.33
R2A	4.6	.179	11.8	.47
R3	6.2	.24	11.8	.47
R4	7.9	.31	14.4	.57
R4A	8.2	.32	17.2	.68
R6	11.5	.45	20.3	.80
R8	15.9	.63	26.0	1.03
R10	19.1	.75	31.8	1.25
R12	22.2	.88	38.1	1.50
R14	25.4	1.00	44.5	1.75
R16	28.6	1.13	47.6	1.88
R18	31.8	1.25	50.8	2.00
R20	34.9	1.38	54.0	2.13
R22	38.1	1.50	60.3	2.38
R24	41.3	1.63	63.5	2.50
102	17.0	.67	30.0	1.18
103	19.1	.75	35.1	1.38
104	22.6	.89	37.1	1.46
105	27.4	1.08	46.7	1.84
106	34.0	1.34	56.1	2.21
107	38.9	1.53	64.0	2.52
108	43.9	1.73	73.9	2.91
109	49.3	1.94	79.0	3.11
110	54.1	2.13	83.1	3.27
111	59.2	2.33	92.9	3.66
112	64.3	2.53	98.0	3.86
113	69.1	2.72	108.0	4.25
114	73.9	2.91	113.0	4.45
115	79.0	3.11	123.0	4.84
116	84.1	3.31	128.0	5.05
117	88.9	3.50	136.0	5.35
118	97.5	3.84	141.0	5.55
119	102.0	4.05	150.0	5.91
120	107.0	4.23	141.0	5.55
121K	115.0	4.53	150.0	5.91
122K	120.0	4.72	160.0	6.30
124K	130.0	5.12	170.0	6.69
126K	140.0	5.51	190.0	7.48
128K	150.0	5.91	200.0	7.87
130K	162.0	6.38	213.0	8.39
132K	172.0	6.77	228.0	8.98
134K	182.0	7.17	248.0	9.76
136K	192.0	7.56	266.0	10.55
138K	202.0	7.95	278.0	10.95
140K	212.0	8.35	298.0	11.73
144K	234.0	9.21	326.0	12.84

MRC Bearing Number	S Min.		H Max.	
	mm	in	mm	in
	132	172.0	6.77	238.0
134	182.0	7.17	253.0	9.96
136	192.0	7.56	266.0	10.55
138	202.0	7.95	288.0	11.34
140	212.0	8.35	308.0	12.13
142	222.0	8.74	326.0	12.84
144	234.0	9.21	336.0	13.23
146	244.0	9.61	356.0	14.02
148	254.0	10.00	372.0	14.65
150	266.0	10.47	392.0	15.43
152	278.0	10.95	412.0	16.22
156	298.0	11.73	442.0	17.40
164	338.0	13.31	482.0	18.98
100K	11.9	.47	24.1	.95
101K	14.0	.55	25.9	1.02
102K	17.0	.67	30.0	1.18
103K	19.1	.75	33.0	1.30
104K	22.6	.89	37.1	1.46
105K	27.4	1.08	41.9	1.65
106K	34.0	1.34	49.0	1.93
107K	38.9	1.53	56.1	2.21
108K	43.9	1.73	62.0	2.44
109K	49.3	1.94	69.0	2.72
110K	54.1	2.13	73.9	2.91
111K	59.2	2.33	83.1	3.27
112K	64.3	2.53	88.1	3.47
113K	69.1	2.72	92.9	3.66
114K	73.9	2.91	103.0	4.06
115K	79.0	3.11	108.0	4.25
116K	84.1	3.31	118.0	4.65
117K	88.9	3.50	123.0	4.84
118K	97.5	3.84	131.0	5.16
119K	102.0	4.05	136.0	5.35
120K	107.0	4.23	141.0	5.55
121K	115.0	4.53	150.0	5.91
122K	120.0	4.72	160.0	6.30
124K	130.0	5.12	170.0	6.69
126K	140.0	5.51	190.0	7.48
128K	150.0	5.91	200.0	7.87
130K	162.0	6.38	213.0	8.39
132K	172.0	6.77	228.0	8.98
134K	182.0	7.17	248.0	9.76
136K	192.0	7.56	266.0	10.55
138K	202.0	7.95	278.0	10.95
140K	212.0	8.35	298.0	11.73
144K	234.0	9.21	326.0	12.84

MRC Bearing Number	S Min.		H Max.	
	mm	in	mm	in
	148K	254.0	10.00	346.0
152K	278.0	10.95	382.0	15.04
156K	298.0	11.73	402.0	15.83
160K	318.0	12.52	442.0	17.40
164K	338.0	13.31	462.0	18.19
200	12.7	.50	24.9	.98
201	14.7	.58	26.9	1.06
202	17.5	.69	30.0	1.18
203	19.6	.77	34.0	1.34
204	23.9	.94	40.9	1.61
205	29.0	1.14	46.0	1.81
206	34.0	1.34	56.1	2.21
207	38.9	1.53	65.0	2.56
208	43.9	1.73	72.9	2.87
209	49.3	1.94	78.0	3.07
210	54.1	2.13	83.1	3.27
211	61.2	2.41	93.5	3.68
212	67.8	2.67	101.0	3.98
213	72.6	2.86	111.0	4.37
214	77.7	3.06	116.0	4.57
215	82.6	3.25	121.0	4.76
216	90.2	3.55	130.0	5.12
217	95.3	3.75	140.0	5.51
218	100.0	3.94	150.0	5.91
219	107.0	4.21	158.0	6.22
220	112.0	4.41	168.0	6.61
221	117.0	4.61	178.0	7.01
222	122.0	4.80	188.0	7.40
224	132.0	5.20	203.0	7.99
226	144.0	5.67	216.0	8.50
228	154.0	6.05	236.0	9.29
230	164.0	6.46	256.0	10.08
232	174.0	6.85	276.0	10.87
234	188.0	7.40	292.0	11.50
236	198.0	7.80	302.0	11.89
238	208.0	8.19	322.0	12.68
240	218.0	8.58	342.0	13.47
242	232.0	9.13	359.0	14.13
244	238.0	9.37	382.0	15.04
246	254.0	10.00	397.0	15.63
248	258.0	10.16	422.0	16.61
250	277.0	10.92	434.0	17.07
252	282.0	11.10	458.0	18.03
256	302.0	11.89	478.0	18.82
260	322.0	12.68	518.0	20.39
264	342.0	13.47	558.0	21.97

Shoulder Diameters for Millimeter and Inch-size MRC Ball Bearings

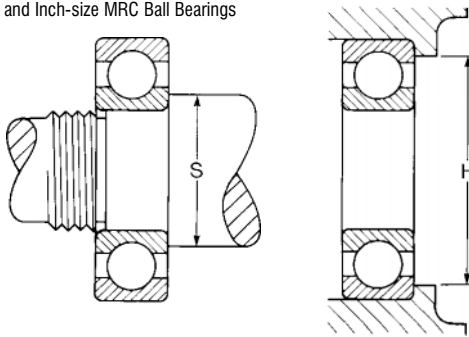

MRC Bearing Number	S Min.		H Max.	
	mm	in	mm	in
300	12.7	.50	30	1.18
301	16.0	.63	31	1.22
302	19.1	.75	36.1	1.42
303	21.1	.83	40.9	1.61
304	23.9	.94	45.0	1.77
305	29.0	1.14	55.1	2.17
306	34.0	1.34	65.0	2.56
307	42.9	1.69	71.1	2.80
308	49.0	1.93	81.0	3.19
309	54.1	2.13	90.9	3.58
310	59.9	2.36	100.0	3.94
311	65.0	2.56	110.0	4.33
312	72.1	2.84	118.0	4.65
313	77.0	3.03	128.0	5.04
314	82.0	3.23	138.0	5.43
315	87.1	3.43	148.0	5.83
316	91.9	3.62	158.0	6.22
317	99.1	3.90	166.0	6.54
318	104.0	4.09	176.0	6.93
319	109.0	4.29	186.0	7.32
320	114.0	4.49	201.0	7.91
321	119.0	4.69	211.0	8.31
322	124.0	4.88	226.0	8.90
324	134.0	5.28	246.0	9.69
326	148.0	5.83	262.0	10.32
328	158.0	6.22	282.0	11.10
330	168.0	6.61	302.0	11.89
332	178.0	7.01	322.0	12.68
334	188.0	7.40	342.0	13.47
336	198.0	7.80	362.0	14.25
338	212.0	8.35	378.0	14.88
340	222.0	8.74	398.0	15.67
342	240.0	9.43	412.0	16.21
344	242.0	9.53	438.0	17.24
348	262.0	10.32	478.0	18.82
352	288.0	11.34	512.0	20.16
356	308.0	12.13	552.0	21.73
403	24.1	.95	55.1	2.17
404	26.9	1.06	65.0	2.56
405	34.0	1.34	71.1	2.80
406	39.1	1.54	81.0	3.19
407	43.9	1.73	90.9	3.58
408	50.0	1.97	100.0	3.94
409	55.1	2.17	110.0	4.33
410	62.0	2.44	118.0	4.65
411	67.1	2.64	128.0	5.04
412	72.1	2.84	138.0	5.43
413	77.0	3.03	148.0	5.83
414	84.1	3.31	166.0	6.54
415	88.9	3.50	176.0	6.93
416	94.0	3.70	186.0	7.32
417	103.0	4.06	192.0	7.56

MRC Bearing Number	S Min.		H Max.	
	mm	in	mm	in
418	108.0	4.25	207.0	8.15
419	109.0	4.30	231.0	9.10
420	121.0	4.75	245.0	9.64
421	130.0	5.10	267.0	10.52
422	138.0	5.42	294.0	11.57
1800	12.0	.47	17.0	.67
1801	14.0	.55	19.0	.75
1802	17.0	.67	22.0	.87
1803	19.0	.75	24.0	.95
1804	22.0	.87	30.0	1.18
1805	27.0	1.06	35.0	1.38
1806	32.0	1.26	40.0	1.58
1807	37.0	1.46	45.0	1.77
1808	42.0	1.65	50.0	1.97
1809	47.0	1.85	56.0	2.21
1810	52.0	2.05	63.0	2.48
1811	57.0	2.24	70.0	2.76
1812	62.0	2.44	76.0	2.99
1813	69.0	2.72	81.0	3.19
1814	74.0	2.91	86.0	3.39
1815	79.0	3.11	91.0	3.58
1816	84.0	3.31	96.0	3.78
1817	90.0	3.54	105.0	4.13
1818	95.0	3.74	110.0	4.33
1819	100.0	3.94	115.0	4.53
1820	105.0	4.13	120.0	4.72
1821	110.0	4.33	125.0	4.92
1822	115.0	4.53	135.0	5.32
1824	125.0	4.92	145.0	5.71
1826	136.5	5.37	158.5	6.24
1828	146.5	5.77	168.5	6.63
1830	156.5	6.16	183.5	7.22
1832	166.5	6.56	193.5	7.62
1834	176.5	6.95	208.5	8.21
1836	186.5	7.34	218.5	8.61
1838	198.0	7.80	232.0	9.13
1840	208.0	8.19	242.0	9.53
1844	228.0	8.98	262.0	10.32
1848	249.0	9.81	291.0	11.46
1852	269.0	10.59	311.0	12.24
1856	289.0	11.38	341.0	13.43
1860	311.0	12.24	369.0	14.53
1864	331.0	13.03	389.0	15.32
1868	351.0	13.82	409.0	16.10
1872	371.0	14.61	429.0	16.89
1876	391.0	15.39	469.0	18.47
1880	411.0	16.18	489.0	19.25
1884	431.0	16.97	509.0	20.04
1888	451.0	17.76	529.0	20.83
1892	473.0	18.62	567.0	22.32
1896	493.0	19.41	587.0	23.11

MRC Bearing Number	S Min.		H Max.	
	mm	in	mm	in
1900	11.2	.44	20.8	.82
1901	13.2	.52	22.9	.90
1902	16.3	.64	26.9	1.06
1903	18.0	.71	29.0	1.14
1904	21.6	.85	35.3	1.39
1905	26.7	1.05	39.9	1.57
1906	31.8	1.25	45.5	1.79
1907	37.1	1.46	52.8	2.08
1908	42.7	1.68	59.4	2.34
1909	47.8	1.88	65.3	2.57
1910	52.3	2.06	69.6	2.74
1911	58.2	2.29	76.7	3.02
1912	63.2	2.49	81.8	3.22
1913	68.1	2.68	86.9	3.42
1914	73.9	2.91	96.0	3.78
1915	78.5	3.09	101.0	3.99
1916	83.8	3.30	106.0	4.18
1917	89.4	3.52	116.0	4.56
1918	94.2	3.71	121.0	4.75
1919	99.8	3.93	125.0	4.93
1920	105.0	4.13	135.0	5.33
1921	110.0	4.33	140.0	5.51
1922	115.0	4.52	145.0	5.70
1924	125.0	4.93	160.0	6.28
1926	136.0	5.36	174.0	6.85
1928	146.0	5.76	184.0	7.24
1930	158.0	6.21	202.0	7.97
1932	168.0	6.62	212.0	8.33
1934	178.0	7.01	222.0	8.74
1936	189.0	7.44	241.0	9.50
1938	199.0	7.83	251.0	9.89
1940	210.0	8.27	269.0	10.61
1944	231.0	9.09	289.0	11.38
1948	251.0	9.88	309.0	12.17
1952	271.0	10.67	349.0	13.74
1956	291.0	11.46	369.0	14.53
1960	313.0	12.32	407.0	16.02
1964	333.0	13.11	427.0	16.81
1968	353.0	13.90	447.0	17.60
1972	373.0	14.69	467.0	18.39
1976	396.0	15.59	504.0	19.84
1980	416.0	16.38	524.0	20.63
1984	436.0	17.17	544.0	21.42
1988	456.0	17.95	584.0	22.99
1992	476.0	18.74	604.0	23.78
XLS1 ³ / ₈	39.7	1.56	60.3	2.38
XLS1 ¹ / ₂	49.2	1.69	63.5	2.50
XLS1 ¹ / ₄	46.0	1.81	68.3	2.69
XLS1 ³ / ₄	49.2	1.94	71.4	2.81
XLS1 ¹ / ₈	52.4	2.06	76.2	3.00
XLS2	55.6	2.19	79.4	3.13
XLS2 ¹ / ₂	60.3	2.38	81.0	3.19

Shaft and Housing Shoulder Diameters

MRC Bearing Services

Shoulder Diameters for Millimeter and Inch-size MRC Ball Bearings

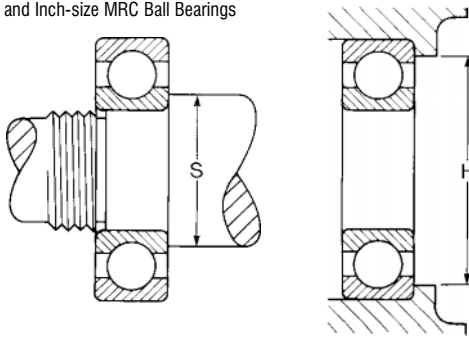

MRC Bearing Number	S		H	
	Min. mm	Min. in	Max. mm	Max. in
XLS2¼	63.5	2.50	84.1	3.31
XLS2¾	66.7	2.63	88.9	3.50
XLS2½	69.9	2.75	92.1	3.63
XLS2⅝	73.0	2.88	98.4	3.88
XLS2¾	76.2	3.00	98.4	3.88
XLS2⅞	81.0	3.19	106.0	4.19
XLS3	84.1	3.31	106.0	4.19
XLS3¼	87.3	3.44	113.0	4.44
XLS3½	90.5	3.56	113.0	4.44
XLS3¾	93.7	3.69	119.0	4.69
XLS3⅞	96.8	3.81	119.0	4.69
XLS3⅝	100.0	3.94	122.0	4.81
XLS3¾	103.0	4.06	122.0	4.81
XLS3⅞	106.0	4.19	135.0	5.31
XLS4	110.0	4.31	135.0	5.31
XLS4¼	113.0	4.44	144.0	5.69
XLS4½	116.0	4.56	144.0	5.69
XLS4⅝	119.0	4.69	151.0	5.94
XLS4¾	122.0	4.81	151.0	5.94
XLS4⅞	125.0	4.94	157.0	6.19
XLS4⅝	129.0	5.06	157.0	6.19
XLS4⅞	132.0	5.19	170.0	6.69
XLS5	135.0	5.31	170.0	6.69
XLS5¼	140.0	5.50	175.0	6.88
XLS5½	143.0	5.63	175.0	6.88
XLS5¾	146.0	5.75	181.0	7.13
XLS5⅞	149.0	5.88	181.0	7.13
XLS5⅝	152.0	6.00	187.0	7.38
XLS5¾	156.0	6.13	187.0	7.38
XLS5⅞	159.0	6.25	194.0	7.63
XLS6	162.0	6.38	194.0	7.63
XLS6¼	168.0	6.63	206.0	8.13
XLS6½	175.0	6.88	213.0	8.38
XLS6¾	184.0	7.25	216.0	8.50
XLS7	191.0	7.50	229.0	9.00
XLS7¼	197.0	7.75	235.0	9.25
XLS7½	203.0	8.00	241.0	9.50
XLS7¾	210.0	8.25	254.0	10.00
XLS8	216.0	8.50	260.0	10.25
XLS8¼	222.0	8.75	267.0	10.50
XLS8½	229.0	9.00	279.0	11.00
XLS8¾	235.0	9.25	286.0	11.25
XLS9	241.0	9.50	292.0	11.50
XLS9½	257.0	10.13	308.0	12.13
XLS10	270.0	10.63	321.0	12.63
XLS10½	283.0	11.13	340.0	13.38
XLS11	295.0	11.63	352.0	13.88
XLS11½	308.0	12.13	371.0	14.63
XLS12	321.0	12.63	391.0	15.38
135	7.0	.28	17.0	.67
126	8.0	.32	17.0	.67
127	9.0	.35	20.0	.79

MRC Bearing Number	S		H	
	Min. mm	Min. in	Max. mm	Max. in
108	10.0	.39	20.0	.79
129	13.0	.51	22.0	.87
1200E	14.0	.55	26.0	1.02
1201E	16.0	.63	28.0	1.10
1202E	19.0	.75	31.0	1.22
1203E	21.0	.83	36.0	1.42
1204E	25.0	.98	42.0	1.65
1205E	30.0	1.18	47.0	1.85
1206E	35.0	1.38	57.0	2.24
1207E	41.5	1.63	65.5	2.58
1208E	46.5	1.83	73.5	2.89
1209E	51.5	2.03	78.5	3.09
1210E	56.5	2.22	83.5	3.29
1211E	63.0	2.48	95.0	3.74
1212E	68.0	2.68	102.0	4.02
1213E	73.0	2.87	112.0	4.41
1214	78.0	3.07	117.0	4.61
1215	83.0	3.27	122.0	4.80
1216	89.0	3.51	131.0	5.16
1217	94.0	3.70	141.0	5.55
1218	99.0	3.90	151.0	5.95
1219	106.0	4.17	159.0	6.26
1220	111.0	4.37	169.0	6.65
1221	116.0	4.57	178.0	7.05
1222	121.0	4.76	189.0	7.44
1224	131.0	5.16	204.0	8.03
1226	143.0	5.63	217.0	8.54
1301E	17.0	.67	32.0	1.26
1302E	20.0	.79	37.0	1.46
1303E	22.0	.87	42.0	1.65
1304E	26.5	1.04	45.5	1.79
1305E	31.5	1.24	55.5	2.19
1306E	36.5	1.44	65.5	2.58
1307E	43.0	1.69	72.0	2.84
1308E	48.0	1.89	82.0	3.23
1309E	53.0	2.09	92.0	3.62
1310E	59.0	2.32	101.0	3.98
1311E	64.0	2.52	111.0	4.37
1312E	71.0	2.80	119.0	4.69
1313E	76.0	2.99	129.0	5.08
1314	81.0	3.19	139.0	5.47
1315	86.0	3.39	149.0	5.87
1316	91.0	3.58	159.0	6.26
1317	98.0	3.86	167.0	6.58
1318	103.0	4.06	177.0	6.97
1319	108.0	4.25	187.0	7.36
1320	113.0	4.45	202.0	7.95
1322	123.0	4.84	227.0	8.94
1406	38.0	1.50	82.0	3.23
1407	43.0	1.69	92.0	3.62
1408	49.0	1.93	101.0	3.98

MRC Bearing Number	S		H	
	Min. mm	Min. in	Max. mm	Max. in
1409	54.0	2.13	111.0	4.37
1410	61.0	2.40	119.0	4.69
1411	66.0	2.60	129.0	5.08
1412	71.0	2.80	139.0	5.47
2200E	14.0	.55	26.0	1.02
2201E	16.0	.63	28.0	1.10
2202E	19.0	.75	31.0	1.22
2203E	21.0	.83	36.0	1.42
2204E	25.0	.98	42.0	1.65
2205E	30.0	1.18	47.0	1.85
2206E	35.0	1.38	57.0	2.24
2207E	41.5	1.63	65.5	2.58
2208E	46.5	1.83	73.5	2.89
2209E	51.5	2.03	78.5	3.09
2210E	56.5	2.22	83.5	3.29
2211E	63.0	2.48	95.0	3.74
2212E	68.0	2.68	102.0	4.02
2213E	73.0	2.87	112.0	4.41
2214	78.0	3.07	117.0	4.61
2215	83.0	3.27	122.0	4.81
2216E	89.0	3.50	131.0	5.16
2217	94.0	3.70	141.0	5.55
2218	99.0	3.90	151.0	5.95
2219	106.0	4.17	159.0	6.26
2220	111.0	4.37	169.0	6.65
2221	116.0	4.57	179.0	7.05
2222	121.0	4.76	189.0	7.44
2301	17.0	.67	32.0	1.26
2302	20.0	.79	37.0	1.46
2303	22.0	.87	42.0	1.65
2304	26.5	1.04	45.5	1.79
2305	31.5	1.24	55.5	2.19
2306	36.5	1.44	65.5	2.58
2307E	43.0	1.69	72.0	2.84
2308E	48.0	1.89	82.0	3.23
2309E	53.0	2.09	92.0	3.62
2310	59.0	2.32	101.0	3.98
2311	64.0	2.52	111.0	4.37
2312	71.0	2.80	119.0	4.69
2313	76.0	2.99	129.0	5.08
2314	81.0	3.19	139.0	5.47
2315	86.0	3.39	149.0	5.87
2316	91.0	3.58	159.0	6.26
2317	98.0	3.86	167.0	6.58
2318	103.0	4.06	177.0	6.97
2319	108.0	4.25	187.0	7.36
2320	113.0	4.45	202.0	7.95
2322	123.0	4.84	227.0	8.94
11204E	—	—	42.0	1.65
11205E	—	—	47.0	1.85
11206E	—	—	57.0	2.24

Shoulder Diameters for Millimeter and Inch-size MRC Ball Bearings

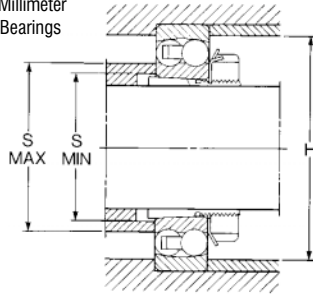

Self-Aligning Bearing with Adapter Sleeve																		
MRC Bearing Number	S		H		MRC Bearing Number	S				H		MRC Bearing Number	S				H	
	Min.		Max.			Max.		Min.		Max.			Max.		Min.		Max.	
	mm	in	mm	in		mm	in	mm	in	mm	in		mm	in	mm	in	mm	in
11207E	—	—	65.5	2.58	1204EK	28.5	1.12	23.0	.91	42.0	1.65	2305K	35.0	1.38	30.0	1.18	55.0	2.19
11208E	—	—	73.5	2.89	1205EK	33.0	1.30	28.0	1.10	47.0	1.85	2306K	41.0	1.61	35.0	1.38	65.5	2.58
11209E	—	—	78.5	3.09	1206EK	40.0	1.58	33.0	1.30	57.0	2.24	2307EK	46.0	1.81	40.0	1.58	72.0	2.84
11210E	—	—	83.5	3.29	1207EK	47.0	1.85	38.0	1.50	65.5	2.58	2308EK	53.0	2.09	45.0	1.77	82.0	3.23
11212E	—	—	102.5	4.02	1208EK	53.0	2.09	43.0	1.69	73.5	2.89	2309EK	60.0	2.36	50.0	1.97	92.0	3.62
					1209EK	57.0	2.24	48.0	1.89	78.5	3.09	2310K	65.0	2.56	56.0	2.21	101.0	3.98
11305E	—	—	55.5	2.19	1210EK	62.0	2.44	53.0	2.09	83.5	3.29	2311K	72.0	2.84	61.0	2.40	111.0	4.37
11306E	—	—	65.5	2.58	1211EK	70.0	2.76	60.0	2.36	95.0	3.74	2312K	76.0	2.99	66.0	2.60	119.0	4.69
11307E	—	—	72.0	2.84	1212EK	78.0	3.07	64.0	2.52	102.0	4.02	2313K	85.0	3.35	72.0	2.84	129.0	5.08
11308E	—	—	82.0	3.23	1213K	85.0	3.35	70.0	2.76	112.0	4.41	2315K	97.0	3.82	82.0	3.23	149.0	5.87
11310E	—	—	101.0	3.98	1215K	93.0	3.66	80.0	3.15	122.0	4.81	2316K	104.0	4.09	88.0	3.47	159.0	6.26
					1216K	101.0	3.98	85.0	3.35	131.0	5.16	2317K	111.0	4.37	94.0	3.70	167.0	6.58
Ball Screw Supports					1217K	107.0	4.21	90.0	3.54	141.0	5.55	2318K	115.0	4.53	100.0	3.94	177.0	6.97
J078DF	27.3	1.07	41.7	1.64	1218K	112.0	4.41	95.0	3.74	151.0	5.95	2319K	121.0	4.76	105.0	4.13	187.0	7.36
J093DF	33.3	1.31	55.3	2.18	1219K	120.0	4.72	100.0	3.94	159.0	6.26	2320K	130.0	5.12	110.0	4.33	202.0	7.95
J098DF	36.3	1.43	55.3	2.18	1220K	127.0	5.00	106.0	4.17	169.0	6.65	2322K	145.0	5.71	121.0	4.76	227.0	8.94
J150DF	47.1	1.86	63.0	2.48	1221K	134.0	5.28	111.0	4.37	179.0	7.05							
J175DF	52.0	2.05	67.9	2.67	1222K	140.0	5.51	116.0	4.57	189.0	7.44							
J225DF	65.2	2.57	81.2	3.20	1224K	150.0	5.91	127.0	5.00	204.0	8.03							
J300DF	85.6	3.37	102.0	4.00	1304EK	33.0	1.30	23.0	.91	45.5	1.79							
J400DF	112.0	4.41	135.0	5.30	1305EK	37.0	1.46	28.0	1.10	55.5	2.19							
					1306EK	44.0	1.73	33.0	1.30	65.5	2.58							
					1307EK	51.0	2.01	39.0	1.54	72.0	2.84							
					1308EK	61.0	2.40	44.0	1.73	82.0	3.23							
					1309EK	67.0	2.64	50.0	1.97	92.0	3.62							
					1310EK	70.0	2.76	55.0	2.17	101.0	3.98							
					1311EK	77.0	3.03	60.0	2.36	111.0	4.37							
					1312EK	87.0	3.43	65.0	2.56	119.0	4.69							
					1313EK	89.0	3.50	70.0	2.76	129.0	5.08							
					1315K	104.0	4.09	80.0	3.15	149.0	5.87							
					1316K	109.0	4.29	85.0	3.35	159.0	6.26							
					1317K	117.0	4.61	91.0	3.58	167.0	6.58							
					1318K	122.0	4.80	96.0	3.78	177.0	6.97							
					1319K	127.0	5.00	102.0	4.02	187.0	7.36							
					1320K	136.0	5.35	108.0	4.25	202.0	7.95							
					1322K	154.0	6.06	118.0	4.65	227.0	8.94							
					2205EK	32.0	1.26	28.0	1.10	47.0	1.85							
					2206EK	38.0	1.50	33.0	1.30	57.0	2.24							
					2207EK	45.0	1.77	39.0	1.54	65.5	2.58							
					2208EK	52.0	2.05	44.0	1.73	73.5	2.89							
					2209EK	55.0	2.17	50.0	1.97	78.5	3.09							
					2210EK	61.0	2.40	55.0	2.17	83.5	3.29							
					2211EK	67.0	2.64	60.0	2.36	92.0	3.62							
					2212EK	74.0	2.91	65.0	2.56	102.0	4.02							
					2213EK	80.0	3.15	70.0	2.76	112.0	4.41							
					2215K	93.0	3.66	80.0	3.15	122.0	4.80							
					2216EK	99.0	3.90	85.0	3.35	131.0	5.16							
					2217K	105.0	4.13	91.0	3.58	141.0	5.55							
					2218K	112.0	4.41	96.0	3.78	151.0	5.95							
					2219K	118.0	4.65	102.0	4.02	159.0	6.26							
					2220K	124.0	4.88	108.0	4.25	169.0	6.65							
					2221K	131.0	5.16	113.0	4.45	179.0	7.05							
					2222K	137.0	5.39	118.0	4.65	189.0	7.44							

NOTES

The ABMA (American Bearing Manufacturers Association) method of identification is arranged in five sections. An abbreviated explanation of each section is provided below. This information will allow

identification of most general purpose bearings. If additional assistance is required please contact MRC Bearing Services.

Schematic Arrangement of Radial Bearings

Radial ball and roller bearings									
Basic Number			Supplementary Number						
Section 1			Section 2			Section 3		Section 4	Section 5
Type and boundary dimensions			Modification of design			Internal fit and tolerances		Lubricants and preservatives	Special requirements
Bore	Type	Outside diameter and width	Cage and separators	Shields and seals	Bearing rings	Internal fit	Tolerances		
				Duplex mounting modification					
0000	AAA	00	A	AA	A	0	0	A	000

Section 1

Bore—Bore Diameter in mm

Type

BC	—S	BD	5000	BS	1200E
BL	—M	BE	5000M	BY	9000H
BH	—R	BG	5000C	BZ	9000U
BA	7000	BF	5000M*	BIC	R(INCH)
BT	7000P	BK	5000C**	BIH	XLS

Outside diameter and width

02 = 200	19 = 1900
03 = 300	32 = 5200
04 = 400	33 = 5300
10 = 100	34 = 5400

Section 2

Cage

- J = Pressed steel
- Y = Pressed brass
- K = Machined bronze, land guided
- D = Non-metallic, land guided
- T = Non-metallic, ball guided
- V = No cage
- X = Any cage acceptable

Shields and seals

- P = Permanently fastened shield
- D = Removable contact seal
- H = Labyrinth seal
- G = Contact seal, any type
- X = Spacer used when no closure required

Bearing ring modification

- G = Snap ring in normal position
- C = Snap ring in opposite position
- N = Snap ring groove, less snap ring
- A = Snap ring groove in opposite position, less snap ring

Duplex mounting

- D = Universally ground single bearing (DU)
- R = DB pair
- U = DF pair
- T = DT pair

Section 3

Internal fit

- 0 = Normal (ST)
- 2 = Tight (TI)
- 3 = Loose (LO)
- 4 = Extra loose (XL)
- 5 = Greater than symbol 4

Duplex bearings

- 7 = Light preload
- 8 = Medium preload
- 9 = Heavy preload

Tolerance

- 0 = ABEC-1
- 6 = ABEC-3
- 5 = ABEC-5
- 4 = ABEC-7
- 2 = ABEC-9

Section 4

Lubricant

- X = Manufacturers standard
- A = Specific lube to satisfy a particular condition

Section 5

Special requirements

See following page

*Radial type, 0° contact angle substitute 5000M.

**Radial type, 0° contact angle substitute 5000C.

Section 5

Special requirements

- 08 = High point of inner ring eccentricity marked on face
- 09 = High point of outer ring eccentricity marked on face
- 10 = High points of inner and outer ring eccentricities marked on faces
- 11 = Surfaces of all steel bearing parts coated by black iron oxide process
- 16 = Bore of inner ring copper plated, .0003 inches thick per side
- 17 = Bore of inner ring and outside surface of outer ring copper plated, .0003 inches thick per side
- 19 = Width tolerance for assembled bearing from thrust face of inner ring to opposite face of outer ring under applied end play gauging load 0 to -.005 inches
- 20 = Rings, rolling elements and cages made of stainless steel
- 25 = Inner and outer rings to be chrome plated
- 26 = Stabilize for size change of less than 0.010% at 300°F after 2500 hours
- 28 = Stabilize for size change of less than 0.015% at 390°F after 2500 hours
- 29 = Stabilize for size change of less than 0.015% at 480°F after 2500 hours
- 30 = Stabilize for size change of less than 0.015% at 570°F after 2500 hours
- 31 = Stabilize for size change of less than 0.015% at 660°F after 2500 hours
- 100 = Government requirements not otherwise coded. Detailed information must be obtained from the appropriate government activity.

210SFFG**50BC02JPPG30X**

50 = Bore in mm
BC = Type S
02 = 200 Series
J = Pressed steel cage
PP = Two shields
G = Snap ring
3 = Loose fit (LO)
0 = ABEC-1
X = Standard lube

113KRDB**65BH10DXXR74**

65 = Bore in mm
BH = Type R
10 = 100 series
D = Phenolic cage
XX = Spacers
R = DB pair
7 = Light preload
4 = ABEC-7

5307CFG**35BG03JPXG00**

35 = Bore in mm
BG = Type 5000C
03 = 300 series
J = Pressed steel cage
P = Shield
X = Spacer
G = Snap ring
0 = Normal fit (ST)
0 = ABEC-1

318 S G**90BC03KXXN4026**

90 = Bore in mm
BC = Type S
03 = 300 series
K = Machined bronze cage
XX = Spacers
N = Snap ring groove, less snap ring
4 = Extra loose fit (XL)
0 = ABEC-1
26 = Stabilize for operation at 300°F

7205 DU**25BA02DXXD0**

25 = Bore in mm
BA = Type 7000
02 = 200 series
D = Phenolic cage
XX = Spacers
D = DU, ½ pair
0 = ABEC-1

Millimeter—Inch Equivalents
(One inch = 25.4 millimeters)

MRC Bearing Services

Note: The + or - sign indicates that the decimal equivalent is larger or smaller than the fractional equivalent.

mm	in			mm	in			mm	in			mm	in		
1	0.0394	1/32	+	56	2.2047	27/32	-	111	4.3701	43/8	-	166	6.5354	617/32	+
2	0.0787	3/32	-	57	2.2441	21/4	-	112	4.4094	413/32	+	167	6.5748	69/16	+
3	0.1181	1/8	-	58	2.2835	29/32	+	113	4.4488	47/16	+	168	6.6142	65/8	-
4	0.1575	5/32	+	59	2.3228	25/16	+	114	4.4882	41/2	-	169	6.6535	621/32	-
5	0.1969	3/16	+	60	2.3622	23/8	-	115	4.5276	417/32	-	170	6.6929	611/16	+
6	0.2362	1/4	-	61	2.4016	213/32	-	116	4.5669	49/16	+	171	6.7323	623/32	+
7	0.2756	9/32	-	62	2.4409	27/16	+	117	4.6063	419/32	+	172	6.7717	625/32	-
8	0.3150	5/16	+	63	2.4803	215/32	+	118	4.6457	421/32	-	173	6.8110	613/16	-
9	0.3543	11/32	+	64	2.5197	217/32	-	119	4.6850	411/16	-	174	6.8504	627/32	+
10	0.3937	13/32	-	65	2.5591	29/16	-	120	4.7244	423/32	+	175	6.8898	67/8	+
11	0.4331	7/16	-	66	2.5984	219/32	+	121	4.7638	43/4	+	176	6.9291	615/16	-
12	0.4724	15/32	+	67	2.6378	25/8	+	122	4.8031	413/16	-	177	6.9685	631/32	-
13	0.5118	1/2	+	68	2.6772	211/16	-	123	4.8425	427/32	-	178	7.0079	7	+
14	0.5512	9/16	+	69	2.7165	223/32	-	124	4.8819	47/8	+	179	7.0472	71/16	-
15	0.5906	19/32	-	70	2.7559	23/4	+	125	4.9213	429/32	+	180	7.0866	73/32	-
16	0.6299	5/8	+	71	2.7953	225/32	+	126	4.9606	431/32	-	181	7.1260	71/8	+
17	0.6693	21/32	+	72	2.8346	227/32	-	127	5.0000	5		182	7.1654	75/32	+
18	0.7087	23/32	-	73	2.8740	27/8	-	128	5.0394	51/32	+	183	7.2047	77/32	-
19	0.7480	3/4	-	74	2.9134	229/32	+	129	5.0787	53/32	-	184	7.2441	71/4	-
20	0.7874	25/32	+	75	2.9528	215/16	+	130	5.1181	51/8	-	185	7.2835	79/32	+
21	0.8268	13/16	+	76	2.9921	3	-	131	5.1575	55/32	+	186	7.3228	75/16	+
22	0.8661	7/8	-	77	3.0315	31/32	+	132	5.1969	53/16	+	187	7.3622	73/8	-
23	0.9055	29/32	-	78	3.0709	31/16	+	133	5.2362	51/4	-	188	7.4016	713/32	-
24	0.9449	15/16	+	79	3.1102	31/8	-	134	5.2756	59/32	-	189	7.4409	77/16	+
25	0.9843	31/32	+	80	3.1496	35/32	-	135	5.3150	55/16	+	190	7.4803	715/32	+
26	1.0236	11/32	-	81	3.1890	33/16	+	136	5.3543	511/32	+	191	7.5197	717/32	-
27	1.0630	11/16	+	82	3.2283	37/32	+	137	5.3937	513/32	-	192	7.5591	79/16	-
28	1.1024	13/32	+	83	3.2677	39/32	-	138	5.4331	57/16	-	193	7.5984	719/32	+
29	1.1417	15/32	-	84	3.3071	35/16	-	139	5.4724	515/32	+	194	7.6378	75/8	+
30	1.1811	13/16	-	85	3.3465	311/32	+	140	5.5118	51/2	+	195	7.6772	711/16	-
31	1.2205	17/32	+	86	3.3858	33/8	+	141	5.5512	59/16	-	196	7.7165	723/32	-
32	1.2598	11/4	+	87	3.4252	37/16	-	142	5.5906	519/32	-	197	7.7559	73/4	+
33	1.2992	15/16	-	88	3.4646	315/32	-	143	5.6299	55/8	+	198	7.7953	725/32	+
34	1.3386	111/32	-	89	3.5039	31/2	+	144	5.6693	521/32	+	199	7.8346	727/32	-
35	1.3780	13/8	+	90	3.5433	317/32	+	145	5.7087	523/32	-	200	7.8740	77/8	-
36	1.4173	113/32	+	91	3.5827	319/32	-	146	5.7480	53/4	-	201	7.9134	729/32	+
37	1.4567	115/32	-	92	3.6220	35/8	-	147	5.7874	525/32	+	202	7.9528	715/16	+
38	1.4961	11/2	-	93	3.6614	321/32	+	148	5.8268	513/16	+	203	7.9921	8	-
39	1.5354	117/32	+	94	3.7008	311/16	+	149	5.8661	57/8	-	204	8.0315	81/32	+
40	1.5748	19/16	+	95	3.7402	33/4	-	150	5.9055	529/32	-	205	8.0709	81/16	+
41	1.6142	15/8	-	96	3.7795	325/32	-	151	5.9449	515/16	+	206	8.1102	81/8	-
42	1.6535	121/32	-	97	3.8189	313/16	+	152	5.9843	531/32	+	207	8.1496	85/32	-
43	1.6929	111/16	+	98	3.8583	327/32	+	153	6.0236	61/32	-	208	8.1890	83/16	+
44	1.7323	123/32	+	99	3.8976	329/32	-	154	6.0630	61/16	+	209	8.2283	87/32	+
45	1.7717	125/32	-	100	3.9370	315/16	-	155	6.1024	63/32	+	210	8.2677	89/32	-
46	1.8110	113/16	-	101	3.9764	331/32	+	156	6.1417	65/32	-	211	8.3071	85/16	-
47	1.8504	127/32	+	102	4.0157	41/32	-	157	6.1811	63/16	-	212	8.3465	811/32	+
48	1.8898	17/8	+	103	4.0551	41/16	-	158	6.2205	67/32	+	213	8.3858	83/8	+
49	1.9291	115/16	-	104	4.0945	43/32	+	159	6.2598	61/4	+	214	8.4252	87/16	-
50	1.9685	131/32	-	105	4.1339	41/8	+	160	6.2992	65/16	-	215	8.4646	815/32	-
51	2.0079	2	+	106	4.1732	43/16	-	161	6.3386	611/32	-	216	8.5039	81/2	+
52	2.0472	21/16	-	107	4.2126	47/32	-	162	6.3780	63/8	+	217	8.5433	817/32	+
53	2.0866	23/32	-	108	4.2520	41/4	+	163	6.4173	613/32	+	218	8.5827	819/32	-
54	2.1260	21/8	+	109	4.2913	49/32	+	164	6.4567	615/32	-	219	8.6220	85/8	-
55	2.1654	25/32	+	110	4.3307	411/32	-	165	6.4961	61/2	-	220	8.6614	821/32	+

Note: The + or - sign indicates that the decimal equivalent is larger or smaller than the fractional equivalent.

mm	in	mm	in	mm	in	mm	in
221	8.7008	8 ¹¹ / ₁₆	+	276	10.8661	10 ⁷ / ₈	-
222	8.7402	8 ³ / ₄	-	277	10.9055	10 ²⁹ / ₃₂	-
223	8.7795	8 ²⁵ / ₃₂	-	278	10.9449	10 ¹⁵ / ₁₆	+
224	8.8189	8 ¹³ / ₁₆	+	279	10.9843	10 ³¹ / ₃₂	+
225	8.8583	8 ²⁷ / ₃₂	+	280	11.0236	11 ¹ / ₃₂	-
226	8.8976	8 ²⁹ / ₃₂	-	281	11.0630	11 ¹ / ₁₆	+
227	8.9370	8 ¹⁵ / ₁₆	-	282	11.1024	11 ³ / ₃₂	+
228	8.9764	8 ³¹ / ₃₂	+	283	11.1417	11 ⁵ / ₃₂	-
229	9.0157	9 ¹ / ₃₂	-	284	11.1811	11 ³ / ₁₆	-
230	9.0551	9 ¹ / ₁₆	-	285	11.2205	11 ⁷ / ₃₂	+
231	9.0945	9 ³ / ₃₂	+	286	11.2598	11 ¹ / ₄	+
232	9.1339	9 ¹ / ₈	+	287	11.2992	11 ⁵ / ₁₆	-
233	9.1732	9 ³ / ₁₆	+	288	11.3386	11 ¹¹ / ₃₂	-
234	9.2126	9 ⁷ / ₃₂	-	289	11.3780	11 ³ / ₈	+
235	9.2520	9 ¹ / ₄	+	290	11.4173	11 ¹³ / ₃₂	+
236	9.2913	9 ⁹ / ₃₂	+	291	11.4567	11 ¹⁵ / ₃₂	-
237	9.3307	9 ¹¹ / ₃₂	-	292	11.4961	11 ¹ / ₂	-
238	9.3701	9 ³ / ₈	-	293	11.5354	11 ¹⁷ / ₃₂	+
239	9.4094	9 ¹³ / ₃₂	+	294	11.5748	11 ⁹ / ₁₆	+
240	9.4488	9 ⁷ / ₁₆	+	295	11.6142	11 ⁵ / ₈	-
241	9.4882	9 ¹ / ₂	-	296	11.6535	11 ²¹ / ₃₂	-
242	9.5276	9 ¹⁷ / ₃₂	-	297	11.6929	11 ¹¹ / ₁₆	+
243	9.5669	9 ⁹ / ₁₆	+	298	11.7323	11 ²³ / ₃₂	+
244	9.6063	9 ¹⁹ / ₃₂	+	299	11.7717	11 ²⁵ / ₃₂	-
245	9.6457	9 ²¹ / ₃₂	-	300	11.8110	11 ¹³ / ₁₆	-
246	9.6850	9 ¹¹ / ₁₆	-	301	11.8504	11 ²⁷ / ₃₂	+
247	9.7244	9 ²³ / ₃₂	+	302	11.8898	11 ⁷ / ₈	+
248	9.7638	9 ³ / ₄	+	303	11.9291	11 ¹⁵ / ₁₆	+
249	9.8031	9 ¹³ / ₁₆	-	304	11.9685	11 ³¹ / ₃₂	-
250	9.8425	9 ²⁷ / ₃₂	-	305	12.0079	12	+
251	9.8819	9 ⁷ / ₈	+	306	12.0472	12 ¹ / ₁₆	-
252	9.9213	9 ²⁹ / ₃₂	+	307	12.0866	12 ³ / ₃₂	-
253	9.9606	9 ³¹ / ₃₂	-	308	12.1260	12 ¹ / ₈	+
254	10.0000	10		309	12.1654	12 ⁵ / ₃₂	+
255	10.0394	10 ¹ / ₃₂	+	310	12.2047	12 ⁷ / ₃₂	-
256	10.0787	10 ³ / ₃₂	-	311	12.2441	12 ¹ / ₄	-
257	10.1181	10 ¹ / ₈	-	312	12.2835	12 ⁹ / ₃₂	+
258	10.1575	10 ⁵ / ₃₂	+	313	12.3228	12 ⁵ / ₁₆	+
259	10.1969	10 ³ / ₁₆	+	314	12.3622	12 ³ / ₈	-
260	10.2362	10 ¹ / ₄	-	315	12.4016	12 ¹³ / ₃₂	-
261	10.2756	10 ⁹ / ₃₂	-	316	12.4409	12 ⁷ / ₁₆	+
262	10.3150	10 ⁵ / ₁₆	+	317	12.4803	12 ¹⁵ / ₃₂	+
263	10.3543	10 ¹¹ / ₃₂	+	318	12.5197	12 ¹⁷ / ₃₂	-
264	10.3937	10 ¹³ / ₃₂	-	319	12.5591	12 ⁹ / ₁₆	-
265	10.4331	10 ⁷ / ₁₆	-	320	12.5984	12 ¹⁹ / ₃₂	+
266	10.4724	10 ¹⁵ / ₃₂	+	321	12.6378	12 ⁵ / ₈	+
267	10.5118	10 ¹ / ₂	+	322	12.6772	12 ¹¹ / ₁₆	-
268	10.5512	10 ⁹ / ₁₆	-	323	12.7165	12 ²³ / ₃₂	-
269	10.5906	10 ¹⁹ / ₃₂	-	324	12.7559	12 ³ / ₄	+
270	10.6299	10 ⁵ / ₈	+	325	12.7953	12 ²⁵ / ₃₂	+
271	10.6693	10 ²¹ / ₃₂	+	326	12.8346	12 ²⁷ / ₃₂	-
272	10.7087	10 ²³ / ₃₂	-	327	12.8740	12 ⁷ / ₈	-
273	10.7480	10 ³ / ₄	-	328	12.9134	12 ²⁹ / ₃₂	+
274	10.7874	10 ²⁵ / ₃₂	+	329	12.9528	12 ¹⁵ / ₁₆	+
275	10.8268	10 ¹³ / ₁₆	+	330	12.9921	13	-
				331	13.0315	13 ¹ / ₃₂	+
				332	13.0709	13 ¹ / ₁₆	+
				333	13.1102	13 ¹ / ₈	-
				334	13.1496	13 ⁵ / ₃₂	-
				335	13.1890	13 ³ / ₁₆	+
				336	13.2283	13 ⁷ / ₃₂	+
				337	13.2677	13 ⁹ / ₃₂	-
				338	13.3071	13 ⁵ / ₁₆	-
				339	13.3465	13 ¹¹ / ₃₂	+
				340	13.3858	13 ³ / ₈	+
				341	13.4252	13 ⁷ / ₁₆	-
				342	13.4646	13 ¹⁵ / ₃₂	-
				343	13.5039	13 ¹ / ₂	+
				344	13.5433	13 ¹⁷ / ₃₂	+
				345	13.5827	13 ¹⁹ / ₃₂	-
				346	13.6220	13 ⁵ / ₈	-
				347	13.6614	13 ²¹ / ₃₂	+
				348	13.7008	13 ¹¹ / ₁₆	+
				349	13.7402	13 ³ / ₄	-
				350	13.7795	13 ²⁵ / ₃₂	-
				351	13.8189	13 ¹³ / ₁₆	+
				352	13.8583	13 ²⁷ / ₃₂	+
				353	13.8976	13 ²⁹ / ₃₂	-
				354	13.9370	13 ¹⁵ / ₁₆	-
				355	13.9764	13 ³¹ / ₃₂	+
				356	14.0157	14 ¹ / ₃₂	-
				357	14.0551	14 ¹ / ₁₆	-
				358	14.0945	14 ³ / ₃₂	+
				359	14.1339	14 ¹ / ₈	+
				360	14.1732	14 ³ / ₁₆	-
				361	14.2126	14 ⁷ / ₃₂	-
				362	14.2520	14 ¹ / ₄	+
				363	14.2913	14 ⁹ / ₃₂	+
				364	14.3307	14 ¹¹ / ₃₂	-
				365	14.3701	14 ³ / ₈	-
				366	14.4094	14 ¹³ / ₃₂	+
				367	14.4488	14 ⁷ / ₁₆	+
				368	14.4882	14 ¹ / ₂	-
				369	14.5276	14 ¹⁷ / ₃₂	-
				370	14.5669	14 ⁹ / ₁₆	+
				371	14.6063	14 ¹⁹ / ₃₂	+
				372	14.6457	14 ²¹ / ₃₂	-
				373	14.6850	14 ¹¹ / ₁₆	-
				374	14.7244	14 ²³ / ₃₂	+
				375	14.7638	14 ³ / ₄	+
				376	14.8031	14 ¹³ / ₁₆	-
				377	14.8425	14 ²⁷ / ₃₂	-
				378	14.8819	14 ⁷ / ₈	+
				379	14.9213	14 ²⁹ / ₃₂	+
				380	14.9606	14 ³¹ / ₃₂	-
				381	15.0000	15	
				382	15.0394	15 ¹ / ₃₂	+
				383	15.0787	15 ³ / ₃₂	-
				384	15.1181	15 ¹ / ₈	-
				385	15.1575	15 ⁵ / ₃₂	+
				386	15.1969	15 ³ / ₁₆	+
				387	15.2362	15 ¹ / ₄	-
				388	15.2756	15 ⁹ / ₃₂	-
				389	15.3150	15 ⁵ / ₁₆	+
				390	15.3543	15 ¹¹ / ₃₂	+
				391	15.3937	15 ¹³ / ₃₂	-
				392	15.4331	15 ⁷ / ₁₆	-
				393	15.4724	15 ¹⁵ / ₃₂	+
				394	15.5118	15 ¹ / ₂	+
				395	15.5512	15 ⁹ / ₁₆	-
				396	15.5906	15 ¹⁹ / ₃₂	-
				397	15.6299	15 ⁵ / ₈	+
				398	15.6693	15 ²¹ / ₃₂	+
				399	15.7087	15 ²³ / ₃₂	-
				400	15.7480	15 ³ / ₄	-
				401	15.7874	15 ²⁵ / ₃₂	+
				402	15.8268	15 ¹³ / ₁₆	+
				403	15.8661	15 ⁷ / ₈	-
				404	15.9055	15 ²⁹ / ₃₂	-
				405	15.9449	15 ¹⁵ / ₁₆	+
				406	15.9843	15 ³¹ / ₃₂	+
				407	16.0236	16 ¹ / ₃₂	-
				408	16.0630	16 ¹ / ₁₆	+
				409	16.1024	16 ³ / ₃₂	+
				410	16.1417	16 ⁵ / ₃₂	-
				411	16.1811	16 ³ / ₁₆	-
				412	16.2205	16 ⁷ / ₃₂	+
				413	16.2598	16 ¹ / ₄	+
				414	16.2992	16 ⁵ / ₁₆	-
				415	16.3386	16 ¹¹ / ₃₂	-
				416	16.3780	16 ³ / ₈	+
				417	16.4173	16 ¹³ / ₃₂	+
				418	16.4567	16 ¹⁵ / ₃₂	-
				419	16.4961	16 ¹ / ₂	-
				420	16.5354	16 ¹⁷ / ₃₂	+
				421	16.5748	16 ⁹ / ₁₆	+
				422	16.6142	16 ⁵ / ₈	-
				423	16.6535	16 ²¹ / ₃₂	-
				424			

*Decimal Equivalents of Fractions
of an Inch*

Decimal Equivalents of Fractions of an Inch

$\frac{1}{64}$.0156	$\frac{33}{64}$.5156
$\frac{1}{32}$.0313	$\frac{17}{32}$.5313
$\frac{3}{64}$.0469	$\frac{35}{64}$.5469
$\frac{1}{16}$.0625	$\frac{9}{16}$.5625
$\frac{5}{64}$.0781	$\frac{37}{64}$.5781
$\frac{3}{32}$.0938	$\frac{19}{32}$.5938
$\frac{7}{64}$.1094	$\frac{39}{64}$.6094
$\frac{1}{8}$.125	$\frac{5}{8}$.625
$\frac{9}{64}$.1406	$\frac{41}{64}$.6406
$\frac{5}{32}$.1563	$\frac{21}{32}$.6563
$\frac{11}{64}$.1719	$\frac{43}{64}$.6719
$\frac{3}{16}$.1875	$\frac{11}{16}$.6875
$\frac{13}{64}$.2031	$\frac{45}{64}$.7031
$\frac{7}{32}$.2188	$\frac{23}{32}$.7188
$\frac{15}{64}$.2344	$\frac{47}{64}$.7344
$\frac{1}{4}$.250	$\frac{3}{4}$.750
$\frac{17}{64}$.2656	$\frac{49}{64}$.7656
$\frac{9}{32}$.2813	$\frac{25}{32}$.7813
$\frac{19}{64}$.2969	$\frac{51}{64}$.7969
$\frac{5}{16}$.3125	$\frac{13}{16}$.8125
$\frac{21}{64}$.3281	$\frac{53}{64}$.8281
$\frac{11}{32}$.3438	$\frac{27}{32}$.8438
$\frac{23}{64}$.3594	$\frac{55}{64}$.8594
$\frac{3}{8}$.375	$\frac{7}{8}$.875
$\frac{25}{64}$.3906	$\frac{57}{64}$.8906
$\frac{13}{32}$.4063	$\frac{29}{32}$.9063
$\frac{27}{64}$.4219	$\frac{59}{64}$.9219
$\frac{7}{16}$.4375	$\frac{15}{16}$.9375
$\frac{29}{64}$.4531	$\frac{61}{64}$.9531
$\frac{15}{32}$.4688	$\frac{31}{32}$.9688
$\frac{31}{64}$.4844	$\frac{63}{64}$.9844
$\frac{1}{2}$.500	1	1

Metric Conversion Factors					
Multiply	by	to obtain	Multiply	by	to obtain
British thermal unit (Btu)	1055.056	Joule (J)	Foot per minute (fpm)	18.288	Meter per hour (m/hr)
British thermal unit (Btu/hour)	0.2930711	Watt (W)	Foot per minute (fpm)	0.3048	Meter per minute (m/min)
Celsius temperature (t_c)	$1.8t_c + 32 = t_f$	Fahrenheit temperature (t_f)	Foot per minute (fpm)	0.00508	Meter per second (m/s)
Celsius temperature (t_c)	$t_c + 273.15 = t_k$	Kelvin temperature (t_k)	Foot per second (fps)	30.48	Centimeter per second (cm/s)
Centimeter (cm)	0.03280840	Foot (ft)	Foot per second (fps)	18.288	Meter per minute (m/min)
Centimeter (cm)	0.3937	Inch (in.)	Foot per second (fps)	0.3048	Meter per second (m/s)
Centimeter (cm)	0.01	Meter (m)	Foot per second per second	0.3048	Meter per second per second (m/s ²)
Centimeter (cm)	10	Millimeter (mm)	Foot-pound-force (ft-lbf)	1.3558:8	Joule (J)
Centimeter per minute (cm/min)	0.3937008	Inch per minute (ipm)	Foot-poundal	0.04214011	Joule (J)
Centimeter per second (cm/s)	1.968504	Foot per minute (fpm)	Foot-pound per hour (ft-lb/hr)	0.0003766161	Watt (W)
Centimeter per second (cm/s)	0.03280840	Foot per second (fps)	Foot-pound per minute (ft-lb/min)	0.02259697	Watt (W)
Cubic centimeter (cm ³)	0.061023	Cubic Inch (in ³)	Gallon, U.S. liquid (gal)	0.003785412	Cubic meter (m ³)
Cubic foot (ft ³)	0.02832	Cubic meter (m ³)	Gallon, U.S. liquid (gal)	3.785412	Liter (l)
Cubic foot (ft ³)	28.31685	Liter (l)	Gallon per minute, U.S. liquid (gpm)	3.785412	Liter per minute (l/min)
Cubic foot per minute (ft ³ /min)	0.004719474	Cubic meter per second (m ³ /s)	Gallon per minute, U.S. liquid (gpm)	0.06309020	Liter per second (l/s)
Cubic foot per minute (ft ³ /min)	28.31685	Liter per minute (l/min)	Gallon per minute, U.S. liquid (gpm)	0.003785412	Cubic meter per minute (m ³ /min)
Cubic inch (in ³)	16.38706	Cubic centimeter (cm ³)	Gallon per minute, U.S. liquid (gpm)	0.00006309020	Cubic meter per second (m ³ /s)
Cubic inch (in ³)	0.00001638706	Cubic meter (m ³)	Gram (g)	0.03527397	Ounce, (Av) (oz)
Cubic inch (in ³)	16.387.06	Cubic millimeter (mm ³)	Gram (g)	0.03215074	Ounce, (troy) (oz)
Cubic meter (m ³)	61,023.76	Cubic inch (in ³)	Gram per cubic centimeter (g/cm ³)	0.3612730	Pound per cubic inch (lb./in ³)
Cubic meter (m ³)	35.3147	Cubic foot (ft ³)	Horsepower (hp)	0.7456999	Kilowatt (kW)
Cubic meter (m ³)	264.1720	Gallon, U.S. liquid (gal)	Horsepower (hp)	745.6999	Watt (W)
Cubic meter (m ³)	1000.0	Liter (l)	Horsepower, Metric (hp)	735.499	Watt (W)
Cubic meter per minute (m ³ /min)	264.1720	Gallon per minute, U.S. liquid (gpm)	Inch (in.)	2.540	Centimeter (cm)
Cubic meter per second (m ³ /s)	2118.880	Cubic foot per minute (ft ³ /min)	Inch (in.)	0.0254	Meter (m)
Cubic meter per second (m ³ /s)	15,850.32	Gallon per minute U.S. liquid (gpm)	Inch (in.)	25.4	Millimeter (mm)
Cubic millimeter (mm ³)	0.00006102376	Cubic inch (in ³)	Inch of mercury, 32°F	3386.39	Newton per square meter (N/m ²)
Dyne	0.00001	Newton (N)	Inch per minute (lpm)	2.54	Centimeter per minute (cm/min)
Dyne-centimeter	0.0000001	Newton-meter (N-m)	Inch per minute (lpm)	0.0254	Meter per minute (m/min)
Fahrenheit temperature (t_f)	$(T_f - 32)/1.8 = T_c$	(t_c)	Inch per minute (lpm)	25.4	Millimeter per minute (mm/min)
Fahrenheit temperature (t_f)	$(t_f + 459.67)/1.8 = t_k$	Kelvin temperature (t_k)	Joule (J)	0.0009478170	British thermal unit (Btu)
Foot (ft)	30.48	Centimeter (cm)	Joule (J)	0.7375621	Foot-pound-force (ft-lbf)
Foot (ft)	0.3048	Meter (m)	Joule (J)	23.73036	Foot-Poundal
Foot per hour (fph)	0.3048	Meter per hour (m/hr)	Joule (J)	0.0002777778	Watt-hour (W-h)
Foot per hour (fph)	0.00508	Meter per minute (m/min)			
Foot per hour (fph)	0.00008466667	Meter per second (m/s)			
Foot per minute (fpm)	0.508	Centimeter per second (cm/s)			

Metric Conversion Factors					
Multiply	by	to obtain	Multiply	by	to obtain
Kelvin temperature (t_k)	$t_k - 273.15 = t_c$	Celsius temperature (t_c)	Meter (m)	1.0936	Yard (yd)
Kelvin temperature (t_k)	$1.8t_k - 459.67 = t_f$	Fahrenheit temperature (t_f)	Meter per hour (m/hr)	3.280840	Foot per hour (fph)
Kilogram (kg)	0.0009842064	ton (long)	Meter per hour (m/hr)	0.5468067	Foot per minute (fpm)
Kilogram (kg)	0.001	ton (metric)	Meter per minute (m/min)	3.280840	Foot per minute (fpm)
Kilogram (kg)	0.001102311	Ton (short)	Meter per minute (m/min)	0.05468067	Foot per second (fps)
kilogram (kg)	35.27397	Ounce, (Av) (oz)	Meter per minute (m/min)	39.37008	Inch per minute (ipm)
Kilogram (kg)	32.15074	Ounce, (Troy) (oz)	Meter per second (m/s)	11,811.02	Foot per hour (fph)
Kilogram (kg)	2.20462	Pound, (Av) (lb)	Meter per second (m/s)	196.8504	Foot per minute (fpm)
Kilogram-force (kgf) or kilopound	9.80665	Newton (N)	Meter per second (m/s)	3.280840	Foot per second (fps)
Kilogram force per square millimeter (kgf/mm ²)	9.806650	Megapascal (MPa) or (MN/m ²)	Microinch	0.0254	Micrometer or Micron
Kilogram-force-meter (kgf-m)	9.806650	Newton-meter (N-m)	Micron	0.0000132	Atmosphere
Kilogram-meter per second (kg-m/s) second	7.233011	Pound-foot per (lb-ft/s)	Micron	0.0000394	Inch of mercury
Kilogram-meter per second (kg-m/s)	86.79614	Pound-inch per second (lb-in./s)	Micron	0.001	Millimeter of mercury (Torr)
Kilogram per cubic meter (kg/m ³)	0.06242797	Pound per cubic foot (lb/ft ³)	Micron	0.0000195	Pound per square inch (psi)
Kilometer (km)	0.6213712	Mile, (U.S. Statute)	Micrometer or micron	39.37008	Microinch
Kilometer per hour (kph)	0.6213712	Mile per hour, (U.S. statute) (mph)	Mile (U.S. Statute)	1.609344	Kilometer (km)
Kilogram-force per square centimeter (kgf/cm ²)	14.22334	Pound per square inch (psi)	Mile per hour (mph)	1.609344	Kilometer per hour (kph)
Kilogram-force per square meter (kgf/m ²)	9.806650	Newton per square meter (N/m ²)	Millimeter (mm)	0.03937008	Inch (in.)
Kilogram-force per square meter (kgf/m ²)	9.806650	Pascal (Pa)	Millimeter (mm)	0.003280840	Foot (ft)
Kilogram-force per square meter (kgf/m ²)	0.2048161	Pound per square foot (lb/ft ²)	Millimeter of Mercury (Torr)	0.00132	Atmosphere
Kilogram-force per square meter (kgf/m ²)	0.001422	Pound per square inch (psi)	Millimeter of Mercury (Torr)	0.0394	Inch of Mercury
Kilowatt (kW)	1.341022	Horsepower (hp)	Millimeter of Mercury (Torr)	1000	Micron
Kilowatt-hour (kwh)	3,600,000	Joule (J)	Millimeter of Mercury (Torr)	0.0195	Pound per square inch (psi)
Kilonewton per square meter kN/m ²)	0.1450377	Pound per square inch (psi)	Millimeter per minute (mm/min)	0.3937008	Inch per minute (ipm)
Liter (l)	0.03531466	Cubic foot (ft ³)	Newton (N)	100,000	Dyne
Liter (l)	0.001	Cubic meter (m ³)	Newton (N)	0.1019716	Kilogram-force or kilopound (kgf)
Liter (l)	0.2641720	Gallon, U.S. liquid (gal)	Newton (N)	3.596942	Ounce-force (ozf)
Liter per minute (lpm)	0.03531466	Cubic foot per minute (ft ³ /min)	Newton (N)	7.23301	Poundal
Liter per minute (lpm)	0.2641720	Gallon per minute, U.S. liquid (gpm)	Newton-meter (N-m)	0.2248089	Pound-force (lbf)
Liter per second (lps)	15.85032	Gallon per minute, U.S. liquid (gpm)	Newton-meter (N-m)	10,000,000	Dyne-centimeter
Megapascal (MPa)	145.0377	Pound per square inch (psi)	Newton-meter (N-m)	0.1019716	Kilogram-force-meter (kgf-m)
Meter (m)	39.37008	Inch (in.)	Newton-meter (N-m)	141.6119	Ounce-force-inch (ozf-in.)
Meter (m)	3.280840	Foot (ft)	Newton-meter (N-m)	0.73756	Pound-force-foot (lbf-ft)
			Newton-millimeter (N-mm)	0.1416119	Ounce-force-inch (ozf-in.)
			Newton per meter (N/m)	0.06852178	Pound-force per foot (lbf/ft)
			Newton per meter (N/m)	0.005710148	Pound-force per inch (lbf/in.)
			Newton per square centimeter (N/cm ²)	1.450377	Pound per square inch (psi)

Metric Conversion Factors					
Multiply	by	to obtain	Multiply	by	to obtain
Newton per square meter (N/m ²)	0.0002953	Inch of mercury	Pound per square inch (psi)	0.70730697	Kilogram per square centimeter (kg/cm ²)
Newton per square meter (N/m ²)	0.1019716	Kilogram per square meter (kg/m ²)	Pound per square inch (psi)	703.1	Kilogram per square meter (kg/m ²)
Newton per square meter (N/m ²)	1.0	Pascal (Pa)	Pound per square inch (psi)	6.8948	Kilonewton per square meter (kN/m ²)
Newton per square meter (N/m ²)	0.0001450	Pound per square inch (psi)	Pound per square inch (psi)	51.500	Micron
Newton per square millimeter (N/mm ²)	145.0377	Pound per square inch (psi)	Pound per square inch (psi)	51.5	Millimeter of Mercury (Torr)
Ounce, (Av) (oz)	28.3495	Gram (g)	Pound per square inch (psi)	0.6894757	Newton per square centimeter (N/cm ²)
Ounce, (troy) (oz)	31.10348	Gram (g)	Pound per square inch (psi)	6894.76	Newton per square meter (N/m ²)
Ounce, (Av) (oz)	0.02834952	Kilogram (kg)	Pound per square inch (psi)	0.006895	Newton per square millimeter (N/mm ²)
Ounce, (Troy) (oz)	0.03110348	Kilogram (kg)	Pound per square inch (psi)	6894.757	Pascal (Pa)
Ounce-force (ozf)	0.2780139	Newton (N)	Square centimeter (cm ²)	0.001076391	Square foot (ft ²)
Ounce-force-inch (ozf-in.)	0.007061552	Newton-meter (N-m)	Square centimeter (cm ²)	0.1550003	Square inch (in. ²)
Ounce-force-inch (ozf-in.)	7.061552	Newton-millimeter (N-mm)	Square foot (ft ²)	929.0304	Square centimeter (cm ²)
Pascal (Pa)	0.1019716	Kilogram per square meter (kg/m ²)	Square foot (ft ²)	0.09290304	Square meter (m ²)
Pascal (Pa)	1.0	Newton per square meter (N/m ²)	Square foot (ft ²)	92,903.04	Square millimeter (mm ²)
Pascal (Pa)	0.02088543	Pound per square foot (lb/ft ²)	Square foot per second (ft ² /s)	0.092900304	Square meter per second (m ² /s)
Pascal (Pa)	0.0001450377	Pound per square inch (psi)	Square inch (in. ²)	6.4516	Square centimeter (cm ²)
Pound, (Av) (lb)	0.453592	Kilogram (kg)	Square inch (in. ²)	0.00064516	Square meter (m ²)
Poundal	0.1382550	Newton (N)	Square inch (in. ²)	645.16	Square millimeter (mm ²)
Pound-foot-(lb-ft)	1.355818	Newton-meter (N-m)	Square meter (m ²)	10.763910	Square foot (ft ²)
Pound-foot per second (lb-ft/s)	0.1382550	Kilogram-meter per second (kg-m/s)	Square meter (m ²)	1550.003	Square inch (in. ²)
Pound-force (lbf)	4.448222	Newton (N)	Square millimeter (mm ²)	0.0001076387	Square foot (ft ²)
Pound-inch per second (lb-in./s)	0.01152125	Kilogram-meter per second (kg-m/s)	Square millimeter (mm ²)	0.001550003	Square inch (in. ²)
Pound per cubic inch (lb/in. ³)	27.67990	Gram per cubic centimeter (g/cm ³)	Ton (metric)	1000	Kilogram (kg)
Pound per cubic foot (lb/ft ³)	16.01846	Kilogram per cubic meter (kg/m ³)	Ton (long)	1016.047	Kilogram (kg)
Pound per foot (lb/ft)	14.59390	Newton per meter (N/m)	Ton (short)	907.1847	Kilogram (kg)
Pound per inch (lb/in.)	175.1268	Newton per meter (N/m)	Torr (mm Hg)	133.322	Pascal (Pa)
Pound per square foot (lb/ft ²)	4.882429	Kilogram per square meter (kg/m ²)	Watt (W)	3.412141	British thermal unit (Btu/hour)
Pound per square foot (lb/ft ²)	47.88026	Newton per square meter (N/m ²)	Watt (W)	2655.224	Foot-pound per hour (ft-lb/hour)
Pound per square foot (lb/ft ²)	47.88026	Pascal (Pa)	Watt (W)	44.25372	Foot-pound per min. (ft-lb/min)
Pound per square inch (psi)	0.063	Atmosphere	Watt (W)	0.001341022	Horsepower (hp)
Pound per square inch (psi)	2.036	Inch of Mercury	Watt (W)	0.001359621	Horsepower (metric) (hp)
			Watt-hour (W-h)	3600.	Joule (J)
			Yard (yd)	0.9144	Meter (m)

Solutions of Triangles

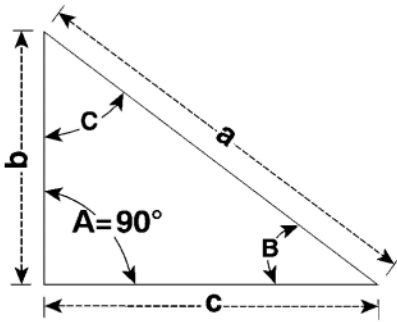

Right-angled Triangles

Sides and Angles Known	Formulas for Sides and Angles to be Found		
Sides a and b	$c = \sqrt{a^2 - b^2}$	$\sin B = \frac{b}{a}$	$C = 90^\circ - B$
Sides a and c	$b = \sqrt{a^2 - c^2}$	$\sin C = \frac{c}{a}$	$B = 90^\circ - C$
Sides b and c	$a = \sqrt{b^2 + c^2}$	$\tan B = \frac{b}{c}$	$C = 90^\circ - B$
Side a; angle B	$b = a \times \sin B$	$c = a \times \cos B$	$C = 90^\circ - B$
Side b; angle B	$a = \frac{b}{\sin B}$	$c = a \times \cot B$	$C = 90^\circ - B$
Side c; angle B	$a = \frac{c}{\cos B}$	$b = c \times \tan B$	$C = 90^\circ - B$

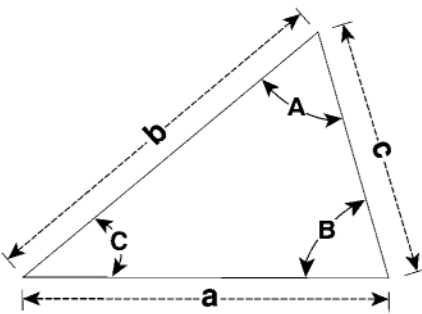

Oblique-angled Triangles

Sides and Angles Known	Formulas for Sides and Angles to be Found		
Side a; angles A, B	$C = 180^\circ - (A + B)$	$b = \frac{a \times \sin B}{\sin A}$	$c = \frac{a \times \sin C}{\sin A}$
Sides a, b; angle C	$\tan A = \frac{a \times \sin C}{b - a \times \cos C}$	$c = \frac{a \times \sin C}{\sin A}$	$B = 180^\circ - (A + C)$
Sides a, b; angle A	$\sin B = \frac{b \times \sin A}{a}$	$C = 180^\circ - (A + B)$	$c = \frac{a \times \sin C}{\sin A}$
Sides a, b, c	$\cos A = \frac{b^2 + c^2 - a^2}{2bc}$	$\sin B = \frac{b \times \sin A}{a}$	$C = 180^\circ - (A + B)$

Areas of Plane Figures

$A = \text{area}$

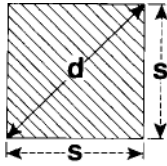

Square

$$A = s^2$$

$$A = \frac{1}{2}d^2$$

$$s = 0.707d = \sqrt{\frac{A}{2}}$$

$$d = 1.414s = 1.414\sqrt{A}$$

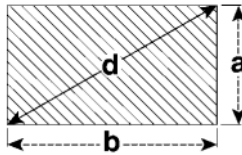

Rectangle

$$A = ab$$

$$A = a\sqrt{d^2 - a^2} = b\sqrt{d^2 - b^2}$$

$$d = \sqrt{a^2 + b^2}$$

$$a = \sqrt{d^2 - b^2} = A \div b$$

$$b = \sqrt{d^2 - a^2} = A \div a$$

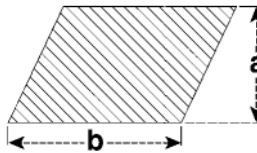

Parallelogram

$$A = ab$$

$$a = A \div b$$

$$b = A \div a$$

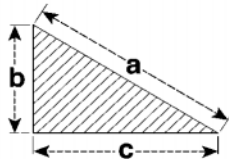

Right-angled Triangle

$$A = \frac{bc}{2}$$

$$a = \sqrt{b^2 + c^2}$$

$$b = \sqrt{a^2 - c^2}$$

$$c = \sqrt{a^2 - b^2}$$

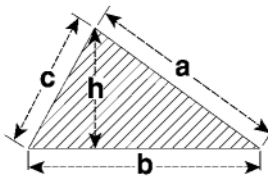

Acute-angled triangle

$$A = \frac{bh}{2} = \frac{b}{2} \sqrt{c^2 - \left(\frac{a^2 + b^2 - c^2}{2b}\right)^2}$$

If $S = \frac{1}{2}(a + b + c)$, then

$$A = \sqrt{S(S-a)(S-b)(S-c)}$$

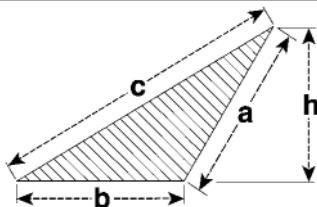

Obtuse-angled triangle

$$A = \frac{bh}{2} = \frac{b}{2} \sqrt{a^2 - \left(\frac{c^2 - a^2 - b^2}{2b}\right)^2}$$

If $S = \frac{1}{2}(a + b + c)$, then

$$A = \sqrt{S(S-a)(S-b)(S-c)}$$

Areas of Plane Figures

A = area

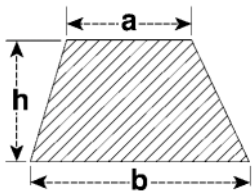

Trapezoid

$$A = \frac{(a + b) h}{2}$$

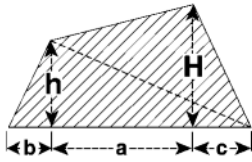

Trapezium

$$A = \frac{(H + h) a + bh + cH}{2}$$

A trapezium can also be divided into two triangles as indicated by the dotted line. The area of each of the triangles is computed, and the results added to find the area of the trapezium.

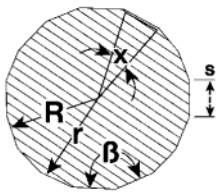

Regular Polygon

n = number of sides.
 $\alpha = 360^\circ \div n$ $\beta = 180^\circ - \alpha$
 $A = \frac{nsr}{2} = \frac{ns}{2} \sqrt{R^2 - \frac{s^2}{4}}$
 $R = \sqrt{r^2 + \frac{s^2}{4}}$, $r = \sqrt{R^2 - \frac{s^2}{4}}$, $s = 2\sqrt{R^2 - r^2}$

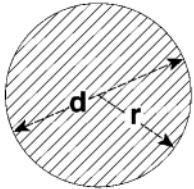

Circle

C = circumference.
 $A = \pi r^2 = 3.1416 r^2 = 0.7854 d^2$
 $C = 2\pi r = 6.2832 r = 3.1416 d$
 $r = C \div 6.2832 = \sqrt{A \div 3.1416} = 0.564 \sqrt{A}$
 $d = C \div 3.1416 = \sqrt{A \div 0.7854} = 1.128 \sqrt{A}$
 Length of arc for center-angle of $1^\circ = 0.008727 d$
 Length of arc for center-angle of $n^\circ = 0.008727 nd$

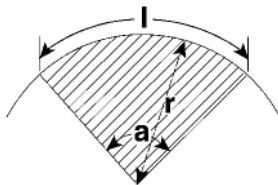

Circular Sector

l = length of arc; α = angle, in degrees.
 $l = \frac{r \times \alpha \times 3.1416}{180} = 0.01745 r\alpha = \frac{2A}{r}$
 $A = \frac{1}{2} rl = 0.008727 \alpha r^2$
 $\alpha = \frac{57.296 l}{r}$ $r = \frac{2A}{l} = \frac{57.296 l}{\alpha}$

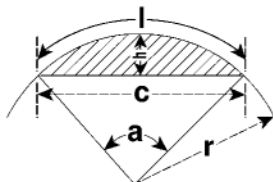

Circular Segment

l = length of arc; α = angle, in degrees.
 $c = 2\sqrt{h(2r-h)}$ $A = \frac{1}{2} [rl - c(r-h)]$
 $r = \frac{c^2 + 4h^2}{8h}$ $l = 0.01745 r\alpha$
 $h = r - \frac{1}{2}\sqrt{4r^2 - c^2}$ $\alpha = \frac{57.296 l}{r}$

Areas of Plane Figures

A = area

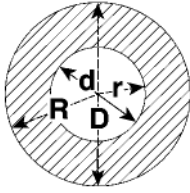

Circular Ring

$$\begin{aligned} A &= \pi (R^2 - r^2) = 3.1416 (R^2 - r^2) \\ &= 3.1416 (R + r) (R - r) \\ &= 0.7854 (D^2 - d^2) = 0.7854 (D + d) (D - d) \end{aligned}$$

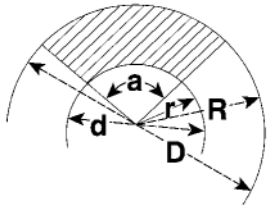

Circular Ring Sector

α = angle, in degrees.

$$\begin{aligned} A &= \frac{\alpha\pi}{360} (R^2 - r^2) = 0.00873 \alpha (R^2 - r^2) \\ &= \frac{\alpha\pi}{4 \times 360} (D^2 - d^2) = 0.00218 \alpha (D^2 - d^2) \end{aligned}$$

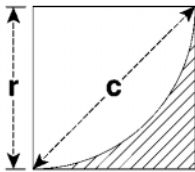

Spandrel or Fillet

$$\begin{aligned} A &= r^2 - \frac{\pi r^2}{4} = 0.215 r^2 \\ &= 0.1075 c^2 \end{aligned}$$

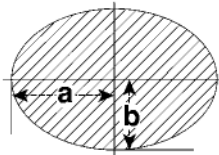

Ellipse

P = perimeter or circumference.

$$\begin{aligned} A &= \pi ab = 3.1416 ab. \\ \text{An approximate formula for the perimeter is:} \\ P &= 3.1416 \sqrt{2(a^2 + b^2)} \\ \text{A closer approximation is:} \\ P &= 3.1416 \sqrt{2(a^2 + b^2) - \frac{(a-b)^2}{2.2}} \end{aligned}$$

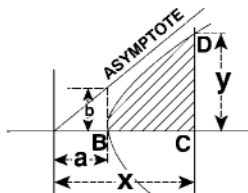

Hyperbola

A = area BCD .

$$A = \frac{xy}{2} - \frac{ab}{2} \text{hyp. log} \left(\frac{x}{a} + \frac{y}{b} \right)$$

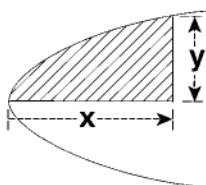

Parabola

$$A = \frac{2}{3} xy$$

(The area is equal to two-thirds of the rectangle which has x for its base and y for its height.)

Volumes of Solids

V = volume

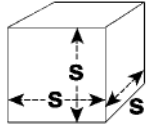

$$V = s^3$$

$$s = \sqrt[3]{V}$$

Cube

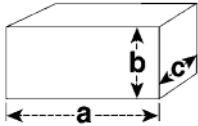

$$V = abc$$

$$a = \frac{V}{bc} \quad b = \frac{V}{ac} \quad c = \frac{V}{ab}$$

Square Prism

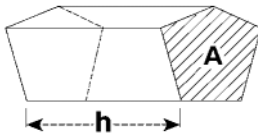

$$A = \text{area of end surface.}$$

$$V = h \times A$$

The area A of the end surface is found by the formulas for areas of plane figures on the preceding pages.

Prism

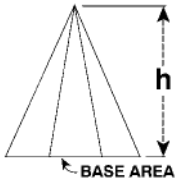

$$V = \frac{1}{3} h \times \text{area of base.}$$

If the base is a regular polygon with n sides, and s = length of side, r = radius of inscribed circle, and R = radius of circumscribed circle, then:

$$V = \frac{nsrh}{6} = \frac{nsh}{6} \sqrt{R^2 - \frac{s^2}{4}}$$

Pyramid

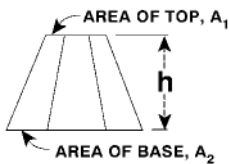

$$V = \frac{h}{3} (A_1 + A_2 + \sqrt{A_1 \times A_2})$$

Frustum of Pyramid

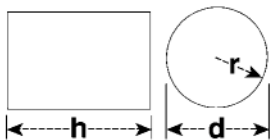

S = area of cylindrical surface.

$$V = 3.1416 r^2 h = 0.7854 d^2 h$$

$$S = 6.2832 rh = 3.1416 dh$$

Total area A of cylindrical surface and end surfaces:

$$A = 6.2832 r (r + h) = 3.1416 d \left(\frac{1}{2} d + h \right)$$

Cylinder

Volumes of Solids

$V =$ volume

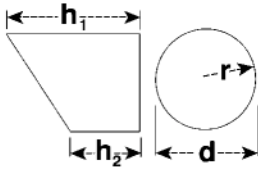

$S =$ area of cylindrical surface.
 $V = 1.5708 r^2 (h_1 + h_2) = 0.3927 d^2 (h_1 + h_2)$
 $S = 3.1416 r (h_1 + h_2) = 1.5708 d (h_1 + h_2)$

Portion of Cylinder

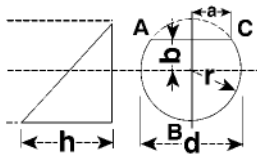

$S =$ area of cylindrical surface.
 $V = \left(\frac{2}{3} a^3 \pm b \times \text{area } ABC \right) \frac{h}{r \pm b}$
 $S = (ad \pm b \times \text{length of arc } ABC) \frac{h}{r \pm b}$

Use + when base area is larger, and - when base area is less than one-half the base circle.

Portion of Cylinder

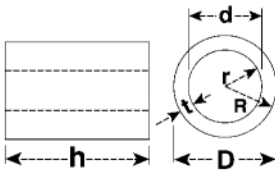

$V = 3.1416 h (R^2 - r^2) = 0.7854 h (D^2 - d^2)$
 $= 3.1416 ht (2R - t) = 3.1416 ht (D - t)$
 $= 3.1416 ht (2r + t) = 3.1416 ht (d + t)$
 $= 3.1416 ht (R + r) = 1.5708 ht (D + d)$

Hollow Cylinder

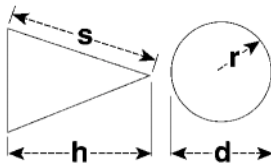

$A =$ area of conical surface.
 $V = \frac{3.1416 r^2 h}{3} = 1.0472 r^2 h = 0.2618 d^2 h$
 $A = 3.1416 r \sqrt{r^2 + h^2} = 3.1416 rs = 1.5708 ds$
 $s = \sqrt{r^2 + h^2} = \sqrt{\frac{d^2}{4} + h^2}$

Cone

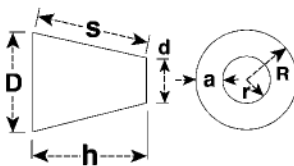

$A =$ area of conical surface.
 $V = 1.0472 h (R^2 + Rr + r^2) = 0.2618 h (D^2 + Dd + d^2)$
 $A = 3.1416 s (R + r) = 1.5708 s (D + d)$
 $a = R - r \quad s = \sqrt{a^2 + h^2} = \sqrt{(R - r)^2 + h^2}$

Frustum of Cone

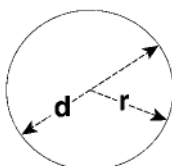

$A =$ area of surface.
 $V = \frac{4 \pi r^3}{3} = \frac{\pi d^3}{6} = 4.1888 r^3 = 0.5236 d^3$
 $A = 4 \pi r^2 = \pi d^2 = 12.5664 r^2 = 3.1416 d^2$
 $r = \sqrt[3]{\frac{3V}{4\pi}} = 0.6204 \sqrt[3]{V}$

Sphere

Volumes of Solids

V = volume

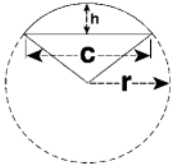

Spherical Sector

A = total area of conical and spherical surface.

$$V = \frac{2 \pi r^2 h}{3} = 2.0944 r^2 h$$

$$A = 3.1416 r \left(2h + \frac{1}{2} c \right)$$

$$c = 2 \sqrt{h(2r-h)}$$

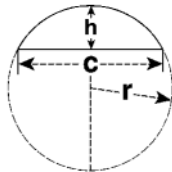

Spherical Segment

A = area of spherical surface.

$$V = 3.1416 h^2 \left(r - \frac{h}{3} \right) = 3.1416 h \left(\frac{c^2}{8} + \frac{h^2}{6} \right)$$

$$A = 2 \pi r h = 6.2832 r h = 3.1416 \left(\frac{c^2}{4} + h^2 \right)$$

$$c = 2 \sqrt{h(2r-h)}; \quad r = \frac{c^2 + 4h^2}{8h}$$

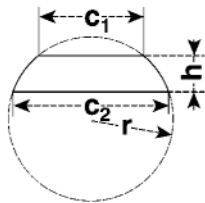

Spherical Zone

A = area of spherical surface.

$$V = 0.5236 h \left(\frac{3c_1^2}{4} + \frac{3c_2^2}{4} + h^2 \right)$$

$$A = 2 \pi r h = 6.2832 r h$$

$$r = \sqrt{\frac{c_2^2}{4} + \left(\frac{c_2^2 - c_1^2 - 4h^2}{8h} \right)^2}$$

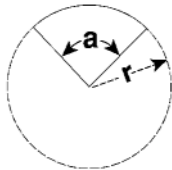

Spherical Wedge

A = area of spherical surface;

α = center angle in degrees

$$V = \frac{\alpha}{360} \times \frac{4 \pi r^3}{3} = 0.0116 \alpha r^3$$

$$A = \frac{\alpha}{360} \times 4 \pi r^2 = 0.0349 \alpha r^2$$

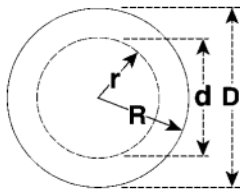

Hollow Sphere

$$V = \frac{4 \pi}{3} (R^3 - r^3) = 4.1888 (R^3 - r^3)$$

$$= \frac{\pi}{6} (D^3 - d^3) = 0.5236 (D^3 - d^3)$$

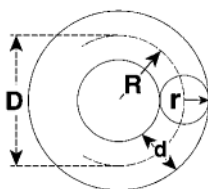

Torus

A = area of surface.

$$V = 2\pi^2 Rr^2 = 19.739 Rr^2$$

$$= \frac{\pi^2}{4} Dd^2 = 2.4674 Dd^2$$

$$A = 4 \pi^2 Rr = 39.478 Rr$$

$$= \pi^2 Dd = 9.8696 Dd$$

Horsepower and Torque

Shaft torque, or twisting moment of the shaft, can be determined from the applied horsepower and speed in the following relationship:

$$Q = \frac{H \times 63000}{R}$$

where, Q = Torque in inch-lbs
 H = Horsepower
 R = Speed in RPM

The torque used in computations is usually that of the main driving shaft or that of the engine or motor. The power is generally transmitted to another shaft by means of gears, pulleys, chains or other drives. The torque of the driving and driven shafts is inversely proportional to the RPM, so that if the torque of the driving shaft and RPM of both shafts are known, the torque of the driven shaft can be determined.

Example:

Fig. 1 shows a gear train, shaft (1) coupled with engine developing 35 horsepower at 1200 r.p.m. The torque of shaft (1) is therefore

$$\frac{63000 \times 35}{1200} = 1840 \text{ in. lbs.}$$

Torque of shaft (2) $1840 \times 48/16 = 5520 \text{ in. lbs.}$

Torque of shaft (3) $5520 \times 24/12 = 11040 \text{ in. lbs.}$

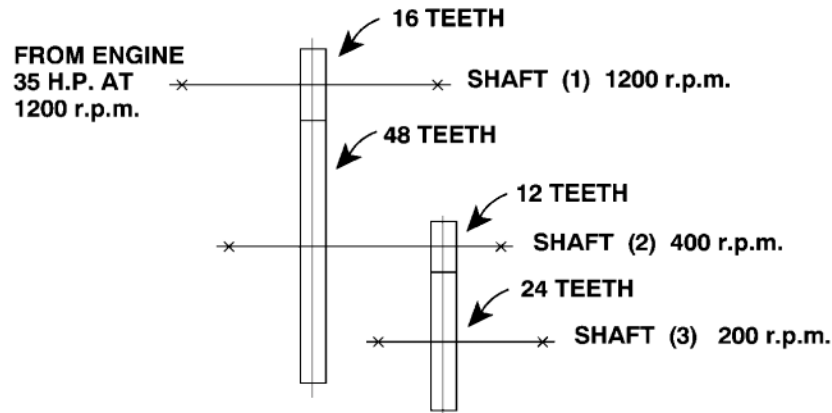

Fig. 1

If the r.p.m. of the shafts is known, the torque is figured directly from the horsepower. For instance the torque of shaft (2) is:

$$\frac{35 \times 63000}{400} = 5520 \text{ inch-pounds.}$$

In some cases, such as on auxiliary drives, a shaft absorbs a certain amount of power from the drive shaft. The torque of the auxiliary shaft is easily computed by substituting values of "H" and "R" in the formula.

Bearing Loads

Radial and Thrust Loads

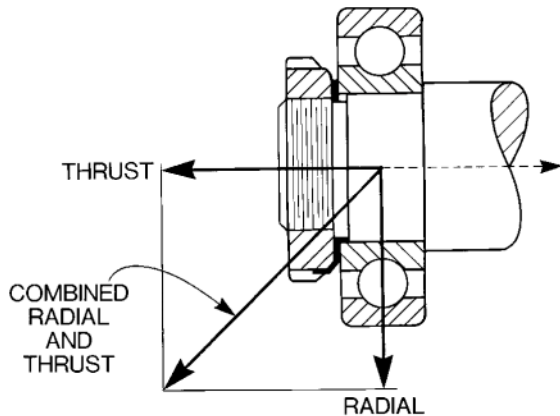

Fig. 2

Radial Loads

A radial load is one applied at right angles to the axis of the shaft. This load passes from the shaft to the inner ring through the balls to the outer ring and thence to the housing. In some cases this condition may be reversed, i. e., the radial load passing from a revolving housing through the bearing to a stationary shaft. A radial load is sustained by not more than one-half of the balls in the bearing.

A radial load may be due to a single force, such as weights of shaft and other revolving parts. More often, however, the radial load is due to two or more components such as tangential forces, separating forces, overturning moments, etc. which are combined into one load acting in a single direction at right angles to the axis of the shaft and the axis of the bearing.

Radial loads are supported by a pair of bearings which are mounted in one of two different manners: (1) Straddle; (2) Overhung. (See following page.)

In the *straddle* mounting, the radial load is divided in inverse proportion to the distance from the point of application of the load to the center of the bearing. The reactions at the bearings act in a direction opposite to

the direction of the load. (See Fig. 3.) The straddle mounting is the most commonly used in supporting shafts.

The *overhung* mounting produces an entirely dissimilar result. In this, the load is applied at a point outside of the two bearings. The effect of this is to produce on the nearest bearing a load greater than the original radial load. The load on the opposite end bearing is generally relatively small. The load on the bearing nearest to the point of application acts in the same direction as that of the applied load. The load at the other bearing acts in the opposite direction to that of the applied load. (See Fig. 4.)

Thrust Loads

A Thrust or End Thrust load is one that acts in the same direction as the axis of the shaft. Its effect is to push the entire circle of balls against the race shoulder. The thrust may act from left to right or from right to left, or it may alternate. In the majority of cases, however, the thrust acts in one direction only. Horizontal mountings always require provision for thrust in both directions, although generally the thrust in one direction may be only a "locating" or nominal thrust. The ideal mounting for a ball bearing is where one bearing takes thrust in both directions. The "opposed" method of mounting allows one bearing to take thrust in one direction, and the other bearing to take thrust in the opposite direction.

Combined Radial and Thrust Loads

One bearing of the pair sustains both radial and thrust loads. The resultant load is indicated by the diagonal line, which also shows the direction in which the shaft would move if not restrained by the bearing.

Bearing Loads

Straddle and Overhung Mountings

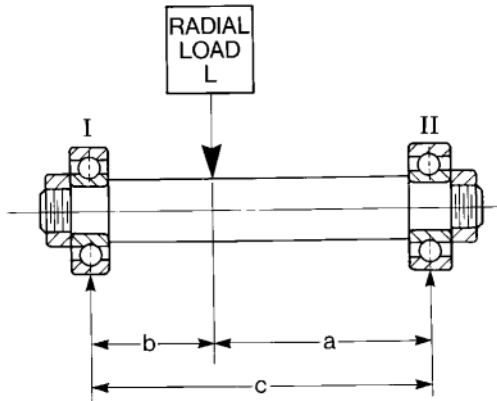

Fig. 3
Straddle Mounting

Radial load on Brg. I $\frac{L \times a}{c}$

Radial load on Brg. II $\frac{L \times b}{c}$

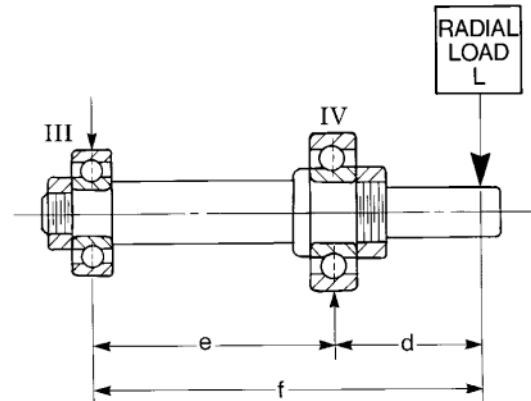

Fig. 4
Overhung Mounting

Radial load on Brg. III $\frac{L \times d}{e}$

Radial load on Brg. IV $\frac{L \times f}{e}$

Example

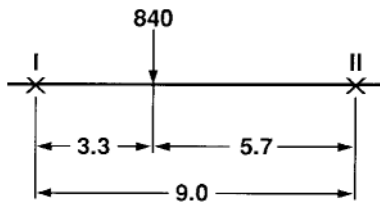

Fig. 5

Radial load on I = $\frac{840 \times 5.7}{9.0} = 530$ lbs.

Radial load on II = $\frac{840 \times 3.3}{9.0} = 310$ lbs.

(530 + 310 = 840 check)

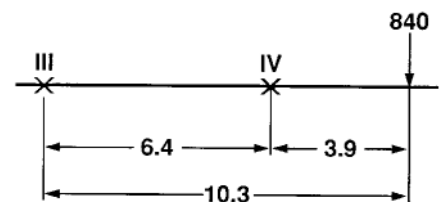

Fig. 6

Radial load on III = $\frac{840 \times 3.9}{6.4} = 510$ lbs.

Radial load on IV = $\frac{840 \times 10.3}{6.4} = 1350$ lbs.

(1350 - 510 = 840 check)

Radial Loads Due to Spur Gears

To compute radial loads on the bearings:—

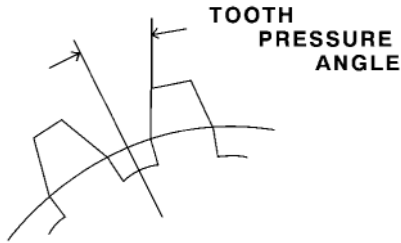

Fig. 7

Obtain following data:

- Horsepower (H) or Torque (Q)
- r.p.m. of driving gear
- Number of teeth (t) in driving gear
- Diametral pitch (p) of gears
- Pitch diameter (D) of driving gear in inches
- Tooth pressure angle
- Gear ratio

Follow the example step by step in solving similar problems.

Example

Horsepower (H) = 35 r.p.m. (R) = 1200
 Number of teeth (t) in driving gear = 18
 Diametral pitch (p) of gears = 6
 Pitch diameter (D) of driving gear = 18/6 = 3
 Tooth pressure angle = A = 17½° COS 17½° = .954
 Gear ratio = 4

$$\text{Torque (Q)} = \frac{63000 H}{R} = \frac{63000 \times 35}{1200} = 1840 \text{ in. lbs.}$$

$$\text{Tooth Load} = \frac{2 Q}{D \cos A} = \frac{2 \times 1840}{3 \times .954} = 1290 \text{ lbs.}$$

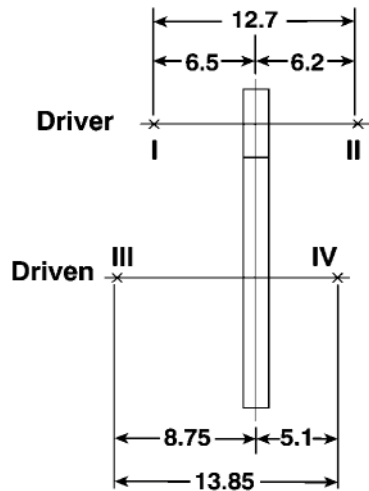

Fig. 8
Straddle Mounting

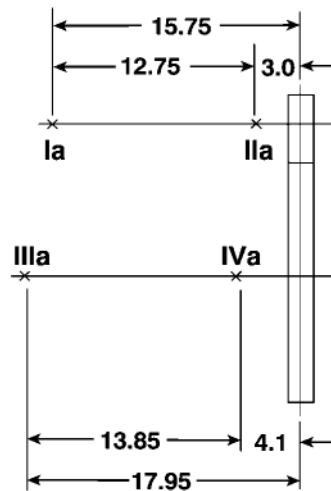

Fig. 9
Overhung Mounting

Radial load on I
 $1290 \times 6.2/12.7 = 630 \text{ lbs. at } 1200 \text{ r.p.m.}$

Radial load on II
 $1290 \times 6.5/12.7 = 660 \text{ lbs. at } 1200 \text{ r.p.m.}$

Radial load on III
 $1290 \times 5.1/13.85 = 480 \text{ lbs. at } 300 \text{ r.p.m.}$

Radial load on IV
 $1290 \times 8.75/13.85 = 810 \text{ lbs. at } 300 \text{ r.p.m.}$

Radial load on Ia
 $1290 \times 3.0/12.75 = 300 \text{ lbs. at } 1200 \text{ r.p.m.}$

Radial load on IIa
 $1290 \times 15.75/12.75 = 1590 \text{ lbs. at } 1200 \text{ r.p.m.}$

Radial load on IIIa
 $1290 \times 4.1/13.85 = 380 \text{ lbs. at } 300 \text{ r.p.m.}$

Radial load on IVa
 $1290 \times 17.95/13.85 = 1670 \text{ lbs. at } 300 \text{ r.p.m.}$

Radial Loads Due to Spur Gears

Idler and Intermediate Shafts Graphic Method

Where loads are due both to driver and driven gears, plot end view and determine resultant load graphically as shown below.

Proceed as follows:

- (1) Draw gears in correct position, preferably to full or half scale.
- (2) Indicate direction of rotation with arrows.
- (3) Draw tangent (same direction as arrows).
- (4) Complete triangle making hypotenuse (tooth load) intersect driven gear.
- (5) Combine two forces as indicated in Fig. 11
- (6) Compute reactions on the bearings. (See page 365)

Example: Horsepower (H) = 35
 r.p.m. (R) of driver = 1200
 Number of teeth in gears 18, 36, 72
 Diametral pitch (p) of gears = 6
 Tooth pressure angle = $17\frac{1}{2}^\circ$

$$\text{Torque (Q)} = \frac{63000 \times 35}{1200} = 1840 \text{ in. lbs.}$$

$$\text{Pitch dia. of driver} = \frac{18}{6} = 3''$$

$$\text{Tooth pressure angle} = A = 17\frac{1}{2}^\circ \cos 17\frac{1}{2}^\circ = .954$$

$$\text{Tooth Load} = \frac{2Q}{D \cos A} = \frac{2 \times 1840}{3 \times .954} = 1290 \text{ pounds}$$

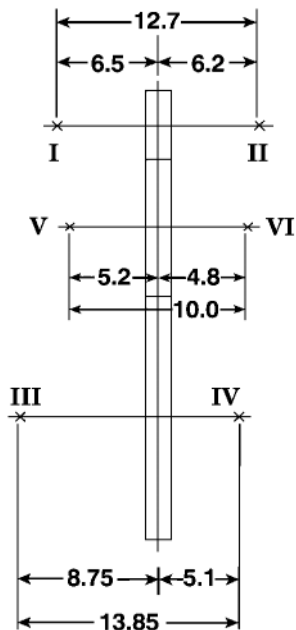

Fig. 10

For loads on bearings on this shaft see opposite page.

For loads on bearings on this shaft see below.

For loads on bearings on this shaft see opposite page.

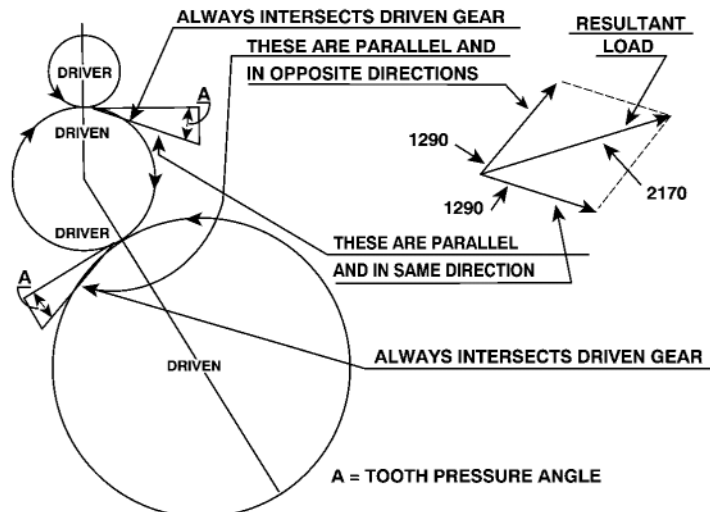

Fig. 11

Load on V $2170 \times 4.8/10 = 1040$ lbs. at 600 r.p.m.
 Load on VI $2170 - 1040 = 1130$ lbs. at 600 r.p.m.

Radial Loads Due to Spur Gears

Idler and Intermediate Shafts Solution by Formulas

Case 1—See Fig. 12 on following page.

H = Horsepower Q = Torque
 R = r.p.m. of driver D = Pitch dia. of driver

$$\text{Resultant tooth load on brgs. V \& VI} = \frac{4 Q}{D} \text{ or } \frac{252000 H}{R D}$$

Example: H = 35 R = 1200 D = 3" Gear reduction = 2

$$\text{Resultant tooth load} = \frac{252000 \times 35}{1200 \times 3} = 2450 \text{ lbs.}$$

Radial load on V $2450 \times 4.8/10 = 1180$ lbs. at 600 r.p.m.
 Radial load on VI $2450 - 1180 = 1270$ lbs. at 600 r.p.m.
 Radial loads on I, II, III and IV—see page 366.

Case 2—See Fig. 14 on following page.

A = Tooth pressure angle Z = angle (fig. 14)

$$K = \frac{2A + Z}{2} \quad \text{Other symbols as in Case (1) above.}$$

$$\text{Resultant tooth load on brgs. V \& VI} = \frac{4 Q \cos K}{D \cos A} \text{ or } \frac{252000 H \cos K}{R D \cos A}$$

Example: H = 35 R = 1200 D = 3" Gear reduction = 2
 Tooth pressure angle = $17\frac{1}{2}^\circ$ $\cos 17\frac{1}{2}^\circ = .954$

$$Z = 30^\circ \quad K = \frac{35 + 30}{2} = 32\frac{1}{2}^\circ \quad \cos 32\frac{1}{2}^\circ = .843$$

$$\text{Resultant tooth load} = \frac{252000 \times 35 \times .843}{1200 \times 3 \times .954} = 2170 \text{ lbs.}$$

Radial load on V $2170 \times 4.8/10 = 1040$ lbs. at 600 r.p.m.
 Radial loads on VI $2170 - 1040 = 1130$ lbs. at 600 r.p.m.
 Radial loads on I, II, III and IV—see page 366.

Case 3—See Fig. 15 on following page.

A = Tooth pressure angle Z = Angle (fig. 15)

$$J = \frac{2A - Z}{2} \quad \text{Other symbols as in Case (1) above.}$$

$$\text{Resultant tooth load on brgs. V \& VI} = \frac{4 Q \cos J}{D \cos A} \text{ or } \frac{252000 H \cos J}{R D \cos A}$$

Example: H = 35 R = 1200 D = 3" Gear reduction = 2
 Tooth pressure angle = $17\frac{1}{2}^\circ$ $\cos 17\frac{1}{2}^\circ = .954$

$$Z = 30^\circ \quad J = \frac{35 - 30}{2} = 2\frac{1}{2}^\circ \quad \cos 2\frac{1}{2}^\circ = .999$$

$$\text{Resultant tooth load} = \frac{252000 \times 35 \times .999}{1200 \times 3 \times .954} = 2570 \text{ lbs.}$$

Radial load on V $2570 \times 4.8/10 = 1230$ lbs. at 600 r.p.m.
 Radial load on VI $2570 - 1230 = 1340$ lbs. at 600 r.p.m.
 Radial loads on I, II, III and IV—see page 366.

Radial Loads Due to Spur Gears

Idler and Intermediate Shafts Solution by Formulas

Case 1: Where centers of driver, idler and driven shafts lie on one line. Direction of rotation of gears is immaterial.

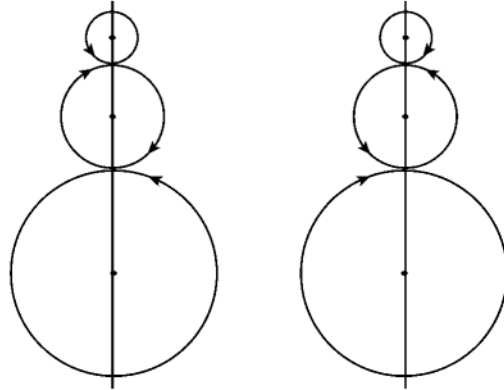

Fig. 12

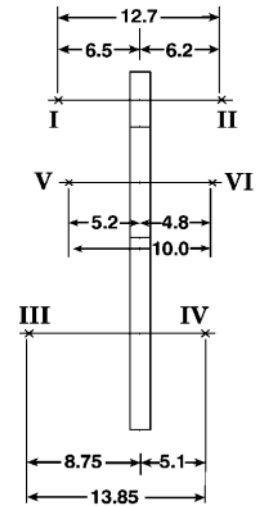

Fig. 13

Case 2: Where end view of gears is as shown in Fig. 14.

Note direction of rotation
(compare Fig. 15 below).

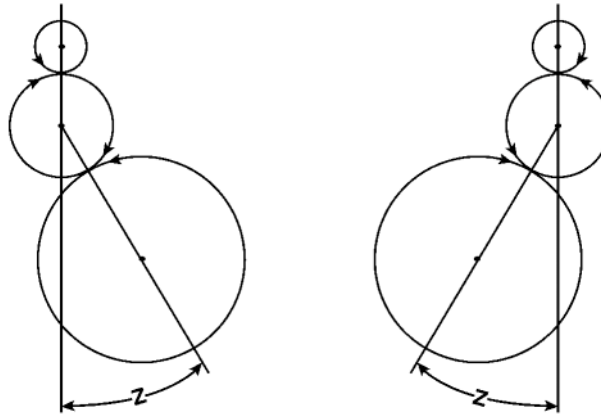

Fig. 14

Case 3: Where end view of gears is as shown in Fig. 15
(compare Fig. 14 above).

Note direction of rotation
(compare Fig. 14 above).

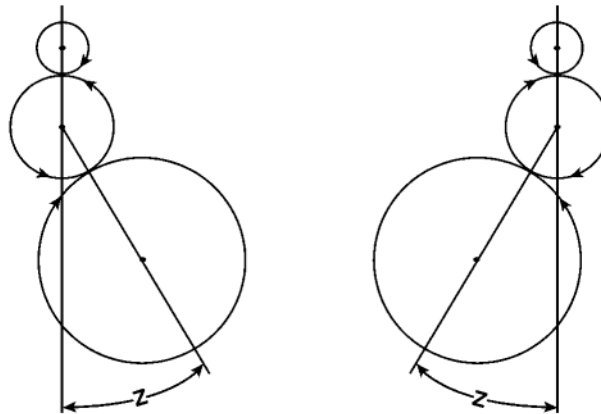

Fig. 15

Loads Due to Planetary Gears

The Methods Shown Consider Simple Planetary Spur Gear Arrangements Only

To compute radial loads on the bearings:

(1) Refer to page 365 for distribution of load (L) on bearings.

(2) Obtain following data:

Horsepower (H) or Torque (Q)

$$\text{Torque in in. lbs. (Q)} = \frac{63000 H}{\text{r.p.m. of driver}}$$

Pitch diameter (s) of sun gear

Pitch diameter (p) of planet gear

Pitch diameter (g) of internal gear

Tooth pressure angle (necessary for single planet drive only)

(3) See table on opposite page which gives resultant radial loads on bearings, and also the r.p.m.'s of the members. Note that the portion of the table devoted to loads is divided into two parts. The first is for the resultant radial load "L" on bearings III & IV for single planet, two planets or three planets. The second is for the resultant radial load "P" on bearings I & II and V & VI for single planet.

(4) Consider first bearings III & IV. Select the proper expression for "L" according to whether your particular problem involves single planet, two planets or three planets.

(5) Resultant radial load "L" is imposed on bearings III & IV. Compute individual loads on III & IV by method shown on page 365, unless planet is supported by a single centrally located bearing in which case "L" is the resultant bearing load.

(6) Bearings III & IV are also subjected to centrifugal forces (except in combinations 3 and 4, see opposite page) which, if the speeds are very high, should be computed and combined with "L" as obtained in (5) above.

These centrifugal forces can be computed from the formula shown below, noting that : "W" equals the weight of the planet gear and shaft; r.p.m. is that of the cage; "r" is as shown in Fig. 19 on the opposite page.

Centrifugal Force (CF) and "L" are combined as follows: $\sqrt{(CF)^2 + L^2}$. Use this instead of "L" when considering centrifugal force. The loads on the individual bearings must be computed as described on page 365.

(Note: the centrifugal force to weight ratio $\frac{CF}{W}$ is of prime importance in the proper selection of the cage used in the bearing, or bearings, on the planet shaft. Send complete data on high speed planetary gear problems for review and selection of bearing type.)

(7) When the planetary drive has a single planet there are also loads on the bearings supporting the driving and driven members. These values are given in the table on the opposite page as load "P" and are imposed on bearings I, II, V & VI. (Note that the expression for "P" is given in terms of "L" as obtained for bearings III & IV due to a single planet.)

Compute the loads on the individual bearings as described on page 365.

For two or more planets, there is no theoretical load on bearings I, II, V & VI. Actually there is some load due to mechanical unbalance and machining inaccuracies, but generally can be neglected.

Centrifugal Force

$$\text{Centrifugal Force} = \frac{W \times r \times R^2}{35200}$$

where W = Weight in pounds

r = Radius in inches

R = r.p.m.

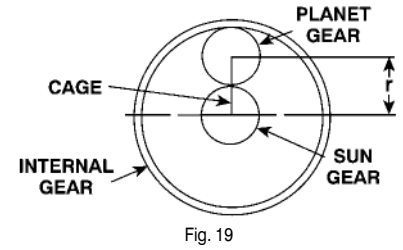
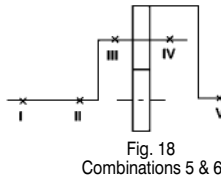
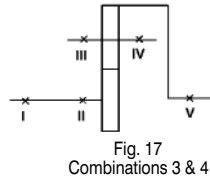
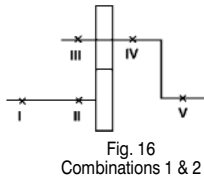

Element		Combination					
		1	2	3	4	5	6
Sun Gear		Driving	Driven	Driving	Driven	Stationary	Stationary
Cage		Driven	Driving	Stationary	Stationary	Driving	Driven
Internal Gear		Stationary	Stationary	Driven	Driving	Driven	Driving
Resultant Radial Load (L) on III & IV	Single Planet	$\frac{4Q}{s}$	$\frac{2Q}{(s+p)}$	$\frac{2Q}{s}$	$\frac{4Q}{g}$	$\frac{2Q}{(s+p)}$	$\frac{4Q}{g}$
	Two Planets	$\frac{2Q}{s}$	$\frac{Q}{(s+p)}$	$\frac{2Q}{s}$	$\frac{2Q}{g}$	$\frac{Q}{(s+p)}$	$\frac{2Q}{g}$
	Three Planets	$\frac{4Q}{3s}$	$\frac{2Q}{3(s+p)}$	$\frac{4Q}{3s}$	$\frac{4Q}{3g}$	$\frac{2Q}{3(s+p)}$	$\frac{4Q}{3g}$
Resultant Radial Load (P) due to Single Planet	See Sketch	Fig. 16		Fig. 17		Fig. 18	
	On I & II	$\frac{L}{2 \cos A}$		$\frac{L}{2 \cos A}$		L	
	On V & VI	L		$\frac{L}{2 \cos A}$		$\frac{L}{2 \cos A}$	
r.p.m.*	Sun Gear	R	$R \times \frac{s}{(g+s)}$	R	$R \times \frac{g}{s}$	0	0
	Planet about own center	$R \times \frac{s}{(g+s)} \times \frac{g}{p}$	$R \times \frac{g}{p}$	$R \times \frac{s}{p}$	$R \times \frac{g}{p}$	$R \times \frac{s}{p}$	$R \times \frac{g}{(g+s)} \times \frac{s}{p}$
	Cage	$R \times \frac{s}{(g+s)}$	R	0	0	R	$R \times \frac{g}{(g+s)}$
	Internal Gear	0	0	$R \times \frac{s}{g}$	R	$R \times \frac{(g+s)}{g}$	R

*In computing r.p.m. it may be more convenient to use number of teeth of gears, that is: s = number of teeth of sun gear; p = number of teeth of planet gear; g = number of teeth of internal gear.

**Loads Due to Belt, Rope and Chain Drives
and Cutting or Working Tools**

General Formula

$$L = \frac{K \times 126000 \times H}{DR}$$

where, L = radial load
 H = horsepower
 D = pitch diameter of pulley sprocket or cutting tool
 R = r.p.m.
 K = service factor

For distribution of load (L) on bearings, refer to page 365.

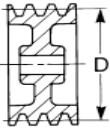
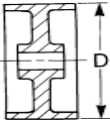
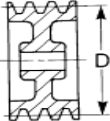
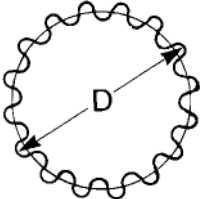
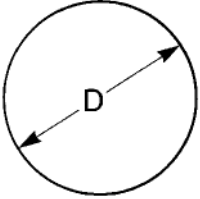
Drive	K
	1.5
	Flat Belt Single Ply 2.0 Double Ply 2.5 Triple Ply, Small Pulley Diameter 3.0
	Rope Pulley Groove Included Angle 45° 2.0 Pulley Groove Included Angle 45°-60° 2.5
	1.25
	5.0

Loads on Electric Motor Bearings

H = Horsepower
R = r.p.m.

W = Weight of rotor in pounds*
D = Diameter of pulley (or pitch dia. of driving gear) in inches

Horizontal Belted Motors

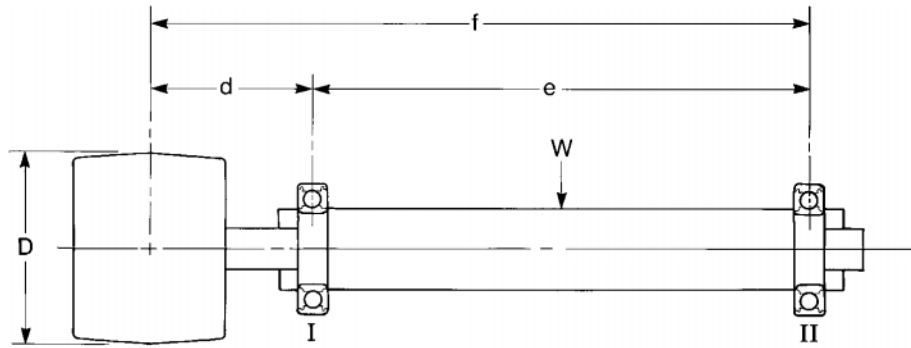

Fig. 20

$$\text{Belt Pull} = \frac{252000 H}{R D} = B$$

$$\begin{aligned} \text{Radial load on I} & \quad (B \times f/e) + W/2 \\ \text{Radial load on II} & \quad (B \times d/e) + W/2 \end{aligned}$$

Example:

$$\begin{array}{lll} H = 30 & W = 240 & d = 8 \\ R = 1200 & D = 10 & e = 24 \\ & & f = 32 \end{array}$$

$$\text{Belt Pull} = \frac{252000 \times 30}{1200 \times 10} = 630 \text{ pounds}$$

$$\text{Radial load on I } 630 \times 32/24 + 240/2 = 960 \text{ lbs. at } 1200 \text{ r.p.m.}$$

$$\text{Radial load on II } 630 \times 8/24 + 240/2 = 330 \text{ lbs. at } 1200 \text{ r.p.m.}$$

Vertical Belted Motors

$$\begin{aligned} \text{Radial load on I} & \quad B \times f/e \\ \text{Radial load on II} & \quad B \times d/e \end{aligned}$$

$$\text{Thrust load on I (or II)} = W$$

\(See formula above for "B")

Horizontal Geared Motors

$$\text{Tooth Load} = \frac{132000 H}{R D} = C$$

$$\begin{aligned} \text{Radial load on I} & \quad (C \times f/e) + W/2 \\ \text{Radial load on II} & \quad (C \times d/e) + W/2 \end{aligned}$$

Direct Coupled Motors

$$\text{Horizontal Motors} \quad \text{Radial load} = W/2 \text{ on each bearing}$$

$$\text{Vertical Motors} \quad \text{Thrust load} = W \text{ on I (or II)}$$

In addition to the above loads there is often a shock load due to the coupling which should be considered in the selection of bearing sizes.

*If unbalanced, "W" equals two or three times the weight of the rotor in the formulas for radial loads.

Thrust Loads

Aircraft, Motor Boats, Twist Drills

Thrust Due to Propellers

H = Brake horsepower of engine

E = Propeller efficiency

R = r.p.m. of engine at rated horsepower

r = r.p.m. of propeller

M = Land miles per hour of motor boat

N = Level flight air speed of aircraft in miles per hour

n = Air speed of aircraft in climb in miles per hour

F = Pitch of propeller in feet

Wanted	Data Given	Formula
Aircraft propeller thrust in level flight	(1) Brake horsepower of engine "H" (2) Level flight air speed of aircraft in miles per hour "N" (Propeller efficiency assumed 85%)	$\frac{320 H}{N}$
Aircraft propeller thrust in level flight	(1) Brake horsepower of engine "H" (2) Level flight air speed of aircraft in miles per hour "N" (3) Propeller efficiency "E"	$\frac{375 H E}{N}$
Aircraft propeller thrust in climb	(1) Brake horsepower of engine "H" (2) Air speed of aircraft in climb in miles per hour "n" (3) r.p.m. of engine "R" (This formula does not apply to variable pitch propellers, where full power and r.p.m. are maintained in climb.)	$\frac{250 H}{n}$ at approx. .9 "R" r.p.m.
Motor Boat propeller thrust	(1) Brake horsepower of engine "H" (2) Propeller efficiency (.60 to .70) "E" (3) Miles per hour of boat "M"	$\frac{375 H E}{M}$
	(1) Brake horsepower of engine "H" (2) Propeller efficiency (.60 to .70) "E" (3) r.p.m. of propeller (4) Pitch of propeller in feet "F"	$\frac{33000 H E}{r F}$

Thrust due to Twist Drills

Drill Size Dia. inches	Drill Feed* inches per one rev.	Thrust Load	
		Mild Steel	Soft Cast Iron
1/16	.003	160	65
1/8	.004	300	130
3/16	.005	460	200
1/4	.006	620	290
5/16	.007	800	380
3/8	.008	990	480
7/16	.009	1180	580
1/2	.010	1380	690
5/8	.011	1710	870
3/4	.012	2040	1050
7/8	.013	2390	1240
1	.014	2740	1440

*Recommended maximum.

Formulas for Automobile Bearing Loads

H = Horsepower of engine
 D = Diameter of tire in inches
 Q = Torque in inch-pounds
 G = Rear Axle reduction
 R = r.p.m. of crankshaft
 M = Miles per hour
 C = Radius to brake pin in inches—Transmission or propeller shaft brake

J = Proportion of weight carried on front axle (generally .45 for passenger cars)
 K = Proportion of weight carried on rear axle (generally .55 for passenger cars)
 W = Total weight, including passengers or pay load in pounds

Wanted	Data Given	Formula
Torque (in inch-pounds)	(1) Torque in foot-pounds	$Q = (\text{Torque in foot-pounds}) \times 12$
Torque (Q)	(1) Horsepower (2) r.p.m.	$Q = \frac{63000 H}{R}$
Horsepower of engine	(1) Torque in inch-pounds (2) r.p.m.	$H = \frac{Q R}{63000}$
Braking torque at rear wheels	(1) Weight on rear axle (2) Diameter of tire	$.3 K W D$
Braking torque at pinion	(1) Weight on rear axle (2) Diameter of tire (3) Axle reduction	$\frac{.3 K W D}{G}$
Transmission or propeller shaft brake load (pivoted brakes)	(1) Weight on rear axle (2) Diameter of tire (3) Axle reduction (4) Radius to brake pin	$\frac{.3 K W D}{G C}$
Radial load on front wheel bearings	(1) Weight on front axle	$\frac{J W}{2}$
Thrust load on front wheel bearings due to side skid	(1) Weight on front axle	$.3 J W$
Radial load on rear wheel bearings	(1) Weight on rear axle	$.64 K W$
Thrust load on rear wheel bearings due to side skid	(1) Weight on rear axle	$.3 K W$
Miles per hour of automobile	(1) r.p.m. of engine (2) Diameter of tire (3) Axle reduction	$\frac{D R}{336 G}$
r.p.m. of engine	(1) Miles per hour (2) Diameter of tire (3) Axle reduction	$\frac{336 M G}{D}$
r.p.m. of axle	(1) Miles per hour (2) Diameter of tire	$\frac{336 M}{D}$
Axle Reduction	(1) Miles per hour (2) Dia. of tire (3) r.p.m. of engine	$\frac{R D}{336 M}$

Shaft Stresses & Deflections

L = Radial load in pounds
 D = Shaft diameter in inches
 H = Horsepower transmitted
 R = Revolutions per minute of shaft
 B = Bore of bearing in inches
 Q = Torque in inch-pounds
 E = Young's modulus (30,000,000 for steel)

S_B = Bending Stresses in pounds per square inch
 S_M = Max. Bending Stress in pounds per square inch
 S_Q = Max. Torsional Stress in pounds per square inch
 M = Deflection of shaft in inches
 M_M = Max. Deflection of shaft in inches
 A = Angularity of shaft at bearing support (subscript indicates support)

For HOLLOW shafts substitute $\left(\frac{D^4 - D_1^4}{D}\right)$ for D^3 and $(D^4 - D_1^4)$ for D^4 (where D_1 = Inside Diameter of hollow shaft or tube).

	Straddle Mounting	Overhung Mounting
Mounting		
Bending Stress		
S_B at x	$S_B = \frac{10.2 L a x}{D^3 c}$	$S_B = \frac{10.2 L d x}{D^3 e}$
S_B at y	$S_B = \frac{10.2 L b y}{D^3 c}$	$S_B = \frac{10.2 L (d - y)}{B^3}$
Max. Stress S_M	$S_M = \frac{10.2 L a b}{D^3 c}$ (at L)	$S_M = \frac{10.2 L a b}{D^3 c}$ (at IV)
Torsional Stress S_Q	$S_Q = \frac{321,000 H}{R D^3}$ or $\frac{5.1 Q}{D^3}$	
Shaft Deflection		
M at x	$M = \frac{3.40 L a x (c^2 - x^2 - a^2)}{c E D^4}$	$M = \frac{3.40 L d x (e^2 - x^2)}{e E D^4}$
M at y	$M = \frac{3.40 L b y (c^2 - y^2 - b^2)}{c E D^4}$	$M = \frac{3.40 L y (3 d y - y^2 + 2 d e)}{E B^4}$
Max. Deflection between Supports M_M	Let a be greater than b Calculate $Y_1 = a \sqrt{\frac{1}{3} + \frac{2 B}{3 a}}$	
	$M_M = \frac{6.80 L b Y_1^3}{c E D^4}$	$M_M = \frac{1.312 L d e^2}{E D^4}$
Deflection at Load M at L	$M = \frac{6.80 L a^2 b^2}{c E D^4}$	$M = \frac{6.80 L d^2 f}{E B^4}$
Angularity of Shaft at Bearing Supports	$\tan A_I = \frac{3.40 L a (c^2 - a^2)}{c E D^4}$ $\tan A_{II} = \frac{3.40 L b (c^2 - b^2)}{c E D^4}$	$\tan A_{III} = \frac{3.40 L d e}{E D^4}$ $\tan A_{IV} = \frac{6.80 L d e}{E B^4}$

Loads Due to Plain Bevel Gears

General Procedure

To compute loads on plain bevel gear, proceed as follows:

(1) Compute torque of driving gear shaft

$$\text{Torque (Q)} = \frac{\text{Horsepower} \times 63000}{\text{r.p.m. of drive shaft}}$$

or

$$\frac{H \times 63000}{R}$$

(2) Determine Tangential Pressure (P)

$$P = \frac{\text{Torque} \times 2}{\text{Mean pitch dia. of driving gear}}$$

or

$$\frac{Q \times 2}{v}$$

(3) Obtain gear thrust by solving for "X" (see below).

(4) Compute radial load on bearings (see example, page 378.)

Thrust Loads

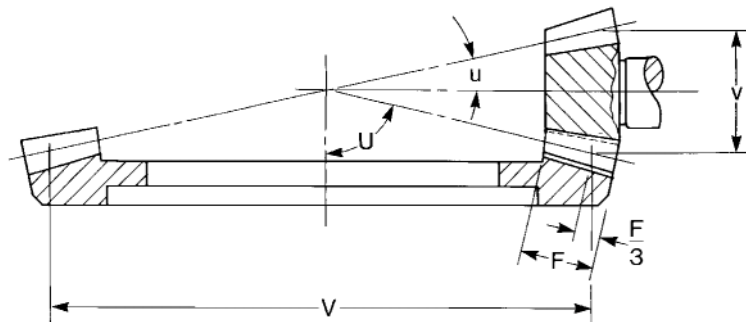

Direction of rotation (clockwise or anticlockwise) viewed from this side.

(Note: Mean Pitch Diameter taken on pitch line $\frac{1}{3}$ face length from pitch diameter, is approximately at the center of the contact area of the gears.)

$$\text{THRUST} = \frac{2 Q X}{v}$$

X = See below

Q = Engine Torque in inch-pounds

G = Gear Ratio

v = Mean Pitch Diameter of Bevel Driving Gear in inches (taken on pitch line $\frac{1}{3}$ face length from pitch dia.)

Value of X

Driving Gear: $X = \text{TAN } A \text{ SIN } u$

Driven Gear: $X = \text{TAN } A \text{ COS } u$

V = Mean Pitch Diameter of Bevel Drive Gear in inches (taken on pitch line $\frac{1}{3}$ face length from pitch dia.)

A = Tooth Pressure Angle

u = Pitch Angle of Driving Gear

$$\text{Tan } u = \frac{\text{No. of teeth in driving gear}}{\text{No. of teeth in driven gear}}$$

Loads due to Plain Bevel Gears

Obtain following data:
 Horsepower (H) or Torque (Q)
 r.p.m. (R) of driving gear shaft
 Mean pitch dia. (v) of driving gear
 Tooth pressure angle

Number of teeth in driving gear
 Number of teeth in driven gear
 Bearing and gear locations (see Figs.)

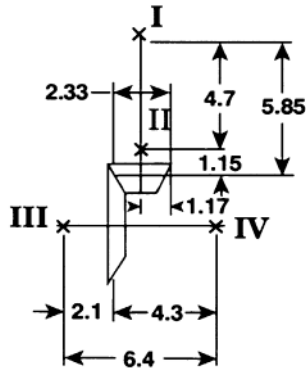

Fig. 23
Overhung Driving Gear

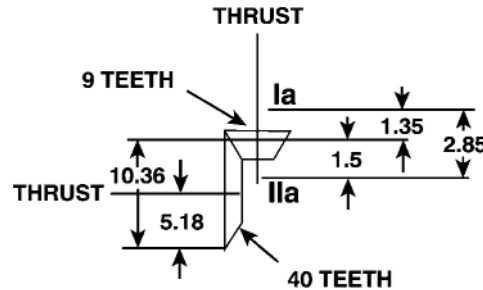

Fig. 24
Straddle Driving Gear

Example:

Horsepower (H) = 35
 r.p.m. (R) = 1200
 Tooth pressure angle = 17½°
 Mean pitch dia. (v) of driving gear = 2.33
 Gear ratio = 40/9 = 4.44
 Mean pitch dia. (V) of driven gear = 2.33 × 4.44 = 10.36
 Pitch angle of driving gear = u
 = tan⁻¹ 9/40 = 12.68°
 Torque (Q) = $\frac{63000 H}{R} = \frac{63000 \times 35}{1200} = 1840$ in. lbs.
 Tangential Pressure (P) = $\frac{2 Q}{v} = \frac{2 \times 1840}{2.33} = 1580$ lbs.

Value of "X" (See page 377.)
 Driver X = TAN A SIN u = TAN 17.5 SIN 12.68 = .07
 Driven X = TAN A COS u = TAN 17.5 COS 12.68 = .31

Thrust on driving gear
 (Tp) = P × X = 1580 × .07 = 110 lbs.
 Thrust on driven gear
 (Tg) = P × X = 1580 × .31 = 490 lbs.
 Overturning moment on driving gear =

$$\frac{T_p \times v/2}{4.7} = \frac{110 \times 1.17}{4.7} = 30 *$$

Overturning moment on driven gear =

$$\frac{T_g \times V/2}{6.4} = \frac{490 \times 5.18}{6.4} = 400 **$$

P	Tp	Tg	v/2	V/2
1580	110	490	1.17	5.18

Driving gear thrust = Tp = 110 pounds thrust on brg. I or Ia.
 Driven gear thrust = Tg = 490 pounds thrust on brg. III.

Brg. I	$1580 \times 1.15/4.7 = 390$	$490 \times 1.15/4.7 = 120$	30 *	
	$\sqrt{390^2 + (120 - 30)^2} = 400$ pounds radial load at 1200 r.p.m.			
Brg. II	$1580 + 390 = 1970$	$490 + 120 = 610$	30 *	
	$\sqrt{1970^2 + (610 - 30)^2} = 2050$ pounds radial load at 1200 r.p.m.			
Brg. III	$1580 \times 4.3/6.4 = 1060$	$110 \times 4.3/6.4 = 70$	400 **	
	$\sqrt{1060^2 + (400 + 70)^2} = 1160$ pounds radial load at 270 r.p.m.			
Brg. IV	$1580 - 1060 = 520$	$110 - 70 = 40$	400 **	
	$\sqrt{520^2 + (400 - 40)^2} = 630$ pounds radial load at 270 r.p.m.			
Brg. Ia	$1580 \times 1.5/2.85 = 830$	$490 \times 1.5/2.85 = 260$	$110 \times 1.17/2.85 = 50$	
	$\sqrt{830^2 + (260 + 50)^2} = 890$ pounds radial load at 1200 r.p.m.			
Brg. IIa	$1580 - 830 = 750$	$490 - 260 = 230$	$110 \times 1.17/2.85 = 50$	
	$\sqrt{750^2 + (230 - 50)^2} = 770$ pounds radial load at 1200 r.p.m.			

<i>Series</i>	<i>Designation</i>	<i>Product</i>	<i>Page</i>
100	Self-Aligning Ball Bearing with Cylindrical Bore		159
100KR	Single-Row 15 Degree Angular Contact Ball Bearing		69
100KRD	Single-Row 15 Degree Angular Contact Duplex Ball Bearing		70
100KS	Single-Row Deep Groove Ball Bearing		49
100KSF	Single-Row Deep Groove Ball Bearing With One Shield		49
100KSFF	Single-Row Deep Groove Ball Bearing With Two Shields		49
100KSFFG	Single-Row Deep Groove Ball Bearing With Two Shields And Snap Ring		49
100KSFG	Single-Row Deep Groove Ball Bearing With One Shield And Snap Ring		49
100KSFZ	Single-Row Deep Groove Ball Bearing With One Shield And One Seal		49
100KSG	Single-Row Deep Groove Ball Bearing With Snap Ring		49
100KSZ	Single-Row Deep Groove Ball Bearing With One Seal		49
100SZZ	Single-Row Deep Groove Ball Bearing With Two Seals		49
100KSZZG	Single-Row Deep Groove Ball Bearing With Two Seals And Snap Ring		49
100M	Single-Row Maximum Capacity Filling Notch Ball Bearing		58
100MF	Single-Row Maximum Capacity Filling Notch Ball Bearing With One Shield		58
100R	Single-Row 15 Degree Angular Contact Ball Bearing		68
100RD	Single-Row 15 Degree Angular Contact Duplex Ball Bearing		68
100S	Single-Row Deep Groove Ball Bearing		48
11200E	Self-Aligning Ball Bearing With Extended Inner Ring		167
11300E	Self-Aligning Ball Bearing With Extended Inner Ring		167
1200	Self-Aligning Ball Bearing With Cylindrical Bore		159
1200E	Self-Aligning Ball Bearing With Cylindrical Bore		159
1200EK	Self-Aligning Ball Bearing With Tapered Bore		162
1200K	Self-Aligning Ball Bearing With Tapered Bore		162
1300	Self-Aligning Ball Bearing With Cylindrical Bore		160
1300E	Self-Aligning Ball Bearing With Cylindrical Bore		160
1300EK	Self-Aligning Ball Bearing With Tapered Bore		162
1300K	Self-Aligning Ball Bearing With Tapered Bore		162
1400	Self-Aligning Ball Bearing With Cylindrical Bore		160
1800S	Single-Row Deep Groove Ball Bearing		46
1800SFP	Single-Row Deep Groove Ball Bearing With One Shield		46
1800SFFP	Single-Row Deep Groove Ball Bearing With Two Shields		46
1800SZ	Single-Row Deep Groove Ball Bearing With One Seal		46
1800SZZ	Single-Row Deep Groove Ball Bearing With Two Seals		46
1900R	Single-Row 15 Degree Angular Contact Ball Bearing		66
1900RD	Single-Row 15 Degree Angular Contact Duplex Ball Bearing		67
1900S	Single-Row Deep Groove Ball Bearing		47
1900SFP	Single-Row Deep Groove Ball Bearing With One Shield		47
1900SFFP	Single-Row Deep Groove Ball Bearing With Two Shields		47
1900SZ	Single-Row Deep Groove Ball Bearing With One Seal		47
1900SZZ	Single-Row Deep Groove Ball Bearing With Two Seals		47
200M	Single-Row Maximum Capacity Filling Notch Ball Bearing		59
200MF	Single-Row Maximum Capacity Filling Notch Ball Bearing With One Shield		59
200MFF	Single-Row Maximum Capacity Filling Notch Ball Bearing With Two Shields		59
200MFFG	Single-Row Maximum Capacity Filling Notch Ball Bearing With Two Shields And Snap Ring		59
200MFG	Single-Row Maximum Capacity Filling Notch Ball Bearing With One Shield And Snap Ring		59
200MG	Single-Row Maximum Capacity Filling Notch Ball Bearing With Snap Ring		59
200R	Single-Row 15 Degree Angular Contact Ball Bearing		71
200RD	Single-Row 15 Degree Angular Contact Duplex Ball Bearing		72
200RDM	Single-Row Dynamometer Ball Bearing		206
200S	Single-Row Deep Groove Ball Bearing		50
200SF	Single-Row Deep Groove Ball Bearing With One Shield		50
200SFF	Single-Row Deep Groove Ball Bearing With Two Shields		50
200SFFC	Single-Row Deep Groove Cartridge Ball Bearing With Two Shields		53
200SFFG	Single-Row Deep Groove Ball Bearing With Two Shields And Snap Ring		50
200SFFX	Single-Row Deep Groove Ball Bearing With Two Shields And Tapered bore		202

Series	Designation Product	Page
200SFZ	Single-Row Deep Groove Ball Bearing With One Shield And One Seal	.50
200SG	Single-Row Deep Groove Ball Bearing With Snap Ring	.50
200SZ	Single-Row Deep Groove Ball Bearing With One Seal	.50
200SZZ	Single-Row Deep Groove Ball Bearing With Two Seals	.50
200SZZC	Single-Row Deep Groove Cartridge Ball Bearing With Two Seals	.53
200SZZG	Single-Row Deep Groove Ball Bearing With Two Seals And Snap Ring	.50
200SZZX	Single-Row Deep Groove Ball Bearing With Two Seals And Tapered Bore	.202
2200	Self-Aligning Ball Bearing With Cylindrical Bore	.161
2200E	Self-Aligning Ball Bearing With Cylindrical Bore	.161
2200EK	Self-Aligning Ball Bearing With Tapered Bore	.163
2200K	Self-Aligning Ball Bearing With Tapered Bore	.163
22002RS1	Self-Aligning Ball Bearing With Cylindrical Bore And Two Seals	.166
22002RS1K	Self-Aligning Ball Bearing With Tapered Bore And Two Seals	.166
2200E2RS1	Self-Aligning Ball Bearing With Cylindrical Bore And Two Seals	.166
2200E2RS1K	Self-Aligning Ball Bearing With Tapered Bore and Two Seals	.166
2300	Self-Aligning Ball Bearing With Cylindrical Bore	.161
2300E	Self-Aligning Ball Bearing With Cylindrical Bore	.161
2300EK	Self-Aligning Ball Bearing With Tapered Bore	.163
2300E2RS1	Self-Aligning Ball Bearing With Cylindrical Bore And Two Seals	.166
2300K	Self-Aligning Ball Bearing With Tapered Bore	.163
30	Single-Row Deep Groove Ball Bearing	.44
30F	Single-Row Deep Groove Ball Bearing With One Shield	.44
30FF	Single-Row Deep Groove Ball Bearing With Two Shields	.44
30Z	Single-Row Deep Groove Ball Bearing With One Seal	.44
30ZZ	Single-Row Deep Groove Ball Bearing With Two Seals	.44
300M	Single-Row Maximum Capacity Filling Notch Ball Bearing	.60
300MF	Single-Row Maximum Capacity Filling Notch Ball Bearing With One Shield	.60
300MFF	Single-Row Maximum Capacity Filling Notch Ball Bearing With Two Shields	.60
300MFFG	Single-Row Maximum Capacity Filling Notch Ball Bearing With Two Shields And Snap Ring	.60
300MFG	Single-Row Maximum Capacity Filling Notch Ball Bearing With One Shield And Snap Ring	.60
300MG	Single-Row maximum Capacity Filling Notch Ball Bearing With Snap Ring	.60
300R	Single-Row 15 Degree Angular Contact Ball Bearing	.73
300RD	Single-Row 15 Degree Angular Contact Duplex Ball Bearing	.74
300RDM	Single-Row Dynamometer Ball Bearing	.207
300S	Single-Row Deep Groove Ball Bearing	.51
300SF	Single-Row Deep Groove Ball Bearing With One Shield	.51
300SFF	Single-Row Deep Groove Ball Bearing With Two Shields	.51
300SFFC	Single-Row Deep Groove Cartridge Ball Bearing With Two Shields	.53
300SFFG	Single-Row Deep Groove Ball Bearing With Two Shields And Snap Ring	.51
300SFG	Single-Row Deep Groove Ball Bearing With One Shield And Snap Ring	.51
300SFZ	Single-Row Deep Groove Ball Bearing With One Shield And One Seal	.51
300SG	Single-Row Deep Groove Ball Bearing With Snap Ring	.51
300SWI	Single-Row Deep Groove Ball Bearing With Wide Inner Ring	.233
300SZ	Single-Row Deep Groove Ball Bearing With One Seal	.51
300SZZ	Single-Row Deep Groove Ball Bearing With Two Seals	.51
300SZZC	Single-Row Deep Groove Cartridge Ball Bearing With Two Seals	.53
300SZZG	Single-Row Deep Groove Ball Bearing With Two Seals And Snap Ring	.51
300WI	Single-Row Maximum Capacity Filling Notch Ball Bearing With Wide Inner Ring	.233
400M	Single-Row Maximum Capacity Filling Notch Ball Bearing	.61
400MF	Single-Row Maximum Capacity Filling Notch Ball Bearing With One Shield	.61
400MFF	Single-Row Maximum Capacity Filling Notch Ball Bearing With Two Shields	.61
400MG	Single-Row Maximum Capacity Filling Notch Ball Bearing With Snap Ring	.61
400R	Single-Row 15 Degree Angular Contact Ball Bearing	.75
400RD	Single-Row 15 Degree Angular Contact Duplex Ball Bearing	.75
400S	Single-Row Deep Groove Ball Bearing	.52
400SF	Single-Row Deep Groove Ball Bearing With One Shield	.52

<i>Series</i>	<i>Designation Product</i>	<i>Page</i>
400SFF	Single-Row Deep Groove Ball Bearing With Two Shields	52
487500	Single-Row Felt Seal Replacement With One Shield, One Seal And Snap Ring	225
488000	Single-Row Felt Seal Replacement With Two Seals And Snap Ring	225
488500	Single-Row Felt Seal Replacement With Two Seals And Snap Ring	225
5200C	Double-Row Angular Contact Non-Filling Notch Ball Bearing	149
5200CF	Double-Row Angular Contact Non-Filling Notch Ball Bearing With One Shield	149
5200CFF	Double-Row Angular Contact Non-Filling Notch Ball Bearing With Two Shields	149
5200CFFG	Double-Row Angular Contact Non-Filling Notch Ball Bearing With Two Shields And Snap Ring	149
5200CFG	Double-Row Angular Contact Non-Filling Notch Ball Bearing With One Shield And Snap Ring	149
5200CFZ	Double-Row Angular Contact Non-Filling Notch Ball Bearing With One Shield And One Seal	149
5200CFZG	Double-Row Angular Contact Non-Filling Notch Ball Bearing With One Shield, One Seal And Snap Ring	149
5200CG	Double-Row Angular Contact Non-Filling Notch Ball Bearing With Snap Ring	149
5200CZ	Double-Row Angular Contact Non-Filling Notch Ball Bearing With One Seal	149
5200CZG	Double-Row Angular Contact Non-Filling Notch Ball Bearing With One Seal And Snap Ring	149
5200CZZ	Double-Row Angular Contact Non-Filling Notch Ball Bearing With Two Seals	149
5200CZZG	Double-Row Angular Contact Non-Filling Notch Ball Bearing With Two Seals And Snap Ring	149
5200C1	Double-Row Angular Contact Non-Filling Notch Ball Bearing, Extra Width	149
5200M	Double-Row Angular Contact Filling Notch Ball Bearing	151
5200MF	Double-Row Angular Contact Filling Notch Ball Bearing With One Shield	151
5200MFF	Double-Row Angular Contact Filling Notch Ball Bearing With Two Shields	151
5200MFFG	Double-Row Angular Contact Filling Notch Ball Bearing With Two Shields And Snap Ring	151
5200MFG	Double-Row Angular Contact Filling Notch Ball Bearing With One Shield And Snap Ring	151
5200MFZ	Double-Row Angular Contact Filling Notch Ball Bearing With One Shield And One Seal	151
5200MFZG	Double-Row Angular Contact Filling Notch Ball Bearing With One Shield, One Seal And Snap Ring	151
5200MG	Double-Row Angular Contact Filling Notch Ball Bearing With Snap Ring	151
5200MZ	Double-Row Angular Contact Filling Notch Ball Bearing With One Seal	151
5200MZG	Double-Row Angular Contact Filling Notch Ball Bearing With One Seal And Snap Ring	151
5200MZZ	Double-Row Angular Contact Filling Notch Ball Bearing With Two Seals	151
5200MZZG	Double-Row Angular Contact Filling Notch Ball Bearing With Two Seals And Snap Ring	151
5200M1	Double-Row Angular Contact Filling Notch Ball Bearing, Extra Width	151
5200SB	Double-Row Angular Contact Non-Filling Notch Ball Bearing	149
5200SBKF	Double-Row Angular Contact Non-Filling Notch Ball Bearing With One Shield	149
5200SBKFF	Double-Row Angular Contact Non-Filling Notch Ball Bearing With Two Shields	149
5200SBKFFG	Double-Row Angular Contact Non-Filling Notch Ball Bearing With Two Seals And Snap Ring	149
5200SBKFG	Double-Row Angular Contact Non-Filling Notch Ball Bearing With One Shield And Snap Ring	149
5200SBKG	Double-Row Angular Contact Non-Filling Notch Ball Bearing With Snap Ring	149
5200SBKZ	Double-Row Angular Contact Non-Filling Notch Contact Ball Bearing With One Seal	149
5200SBKZZ	Double-Row Angular Contact Non-Filling Notch Ball Bearing With Two Seals	149
5300C	Double-Row Angular Contact Non-Filling Notch Ball Bearing	150
5300CF	Double-Row Angular Contact Non-Filling Notch Ball Bearing With One Shield	150
5300CFF	Double-Row Angular Contact Non-Filling Notch Ball Bearing With Two Shields	150
5300CFFG	Double-Row Angular Contact Non-Filling Notch Ball Bearing With Two Shields And Snap Ring	150
5300CFG	Double-Row Angular Contact Non-Filling Notch Ball Bearing With One Shield And Snap Ring	150
5300CFZ	Double-Row Angular Contact Non-Filling Notch Ball Bearing With One Shield And One Seal	150

<i>Series</i>	<i>Designation Product</i>	<i>Page</i>
5300CFZG	Double-Row Angular Contact Non-Filling Notch Ball Bearing With One Shield, One Seal And Snap Ring	150
5300CG	Double-Row Angular Contact Non-Filling Notch Ball Bearing With Snap Ring	150
5300CZ	Double-Row Angular Contact Non-Filling Notch Ball Bearing With One Seal	150
5300CZG	Double-Row Angular Contact Non-Filling Notch Ball Bearing With One Seal And Snap Ring	150
5300CZZ	Double-Row Angular Contact Non-Filling Notch Ball Bearing With Two Seals	150
5300CZZG	Double-Row Angular Contact Non-Filling Notch Ball Bearing With Two Seals And Snap Ring	150
5300C1	Double-Row Angular Contact Non-Filling Notch Ball Bearing, Extra Width	150
5300M	Double-Row Angular Contact Filling Notch Ball Bearing	152
5300MF	Double-Row Angular Contact Filling Notch Ball Bearing With One Shield	152
5300MFF	Double-Row Angular Contact Filling Notch Ball Bearing With Two Shields	152
5300MFFG	Double-Row Angular Contact Filling Notch Ball Bearing With Two Shields And Snap Ring	152
5300MFG	Double-Row Angular Contact Filling Notch Ball Bearing With One Shield And Snap Ring	152
5300MFZ	Double-Row Angular Contact Filling Notch Ball Bearing With One Shield And One Seal	152
5300MFZG	Double-Row Angular Contact Filling Notch Ball Bearing With One Shield, One Seal and Snap Ring	152
5300MZ	Double-Row Angular Contact Filling Notch Ball Bearing With One Seal	152
5300MZZ	Double-Row Angular Contact Filling Notch Ball Bearing With Two Seals	152
5300MZZG	Double-Row Angular Contact Filling Notch Ball Bearing With Two Seals And Snap Ring	152
5300M1	Double-Row Angular Contact Filling Notch Ball Bearing, Extra Width	152
5300SB	Double-Row Angular Contact Non-Filling Notch Ball Bearing	150
5300SBKF	Double-Row Angular Contact Non-Filling Notch Ball Bearing With One Shield	150
5300SBKFF	Double-Row Angular Contact Non-Filling Notch Ball Bearing With Two Shields	150
5300SBKFFG	Double-Row Angular Contact Non-Filling Notch Ball Bearing With Two Shields And Snap Ring	150
5300SBKFG	Double-Row Angular Contact Non-Filling Notch Ball Bearing With One Shield And Snap Ring	150
5300SBKG	Double-Row Angular Contact Non-Filling Notch Ball Bearing With Snap Ring	150
5300SBKZ	Double-Row Angular Contact Non-Filling Notch Ball Bearing With One Seal	150
5300SBKZZ	Double-Row Angular Contact Non-Filling Notch Ball Bearing With Two Seals	150
5400C	Double-Row Angular Contact Non-Filling Notch Ball Bearing	153
7100	Single-Row 29 Degree Angular Contact Ball Bearing	84
7100D	Single-Row 29 Degree Angular Contact Duplex Ball Bearing	84
7100KR	Single-Row 29 Degree Angular Contact Ball Bearing	85
7100KRD	Single-Row 29 Degree Angular Contact Duplex Ball Bearing	86
7200	Single-Row 29 Degree Angular Contact Ball Bearing	87
7200D	Single-Row 29 Degree Angular Contact Duplex Ball Bearing	88
7200P	Single-Row 40 Degree Angular Contact Ball Bearing	98
7200PD	Single-Row 40 Degree Angular Contact Duplex Ball Bearing	99
7200PJ	Single-Row 40 Degree Angular Contact Ball Bearing	110
7200PJD	Single-Row 40 Degree Angular Contact Duplex Ball Bearing	110
7300	Single-Row 29 Degree Angular Contact Ball Bearing	89
7300D	Single-Row 29 Degree Angular Contact Duplex Ball Bearing	90
7300P	Single-Row 40 Degree Angular Contact Ball Bearing	100
7300PD	Single-Row 40 Degree Angular Contact Duplex Ball Bearing	101
7300PJ	Single-Row 40 Degree Angular Contact Ball Bearing	111
7300PJD	Single-Row 40 Degree Angular Contact Duplex Ball Bearing	111
7400	Single-Row 29 Degree Angular Contact Ball Bearing	91
7400D	Single-Row 29 Degree Angular Contact Duplex Ball Bearing	91
7400P	Single-Row 40 Degree Angular Contact Ball Bearing	102
7400PD	Single-Row 40 Degree Angular Contact Duplex Ball Bearing	102
7400PJ	Single-Row 40 Degree Angular Contact Ball Bearing	112
7400PJD	Single-Row 40 Degree Angular Contact Duplex Ball Bearing	112
8000	Single-Row Felt Seal Replacement With One Seal	224
8200	PumPac Duplex Pair Of Angular Contact Ball Bearings	177

<i>Series</i>		<i>Page</i>
<i>Designation</i>	<i>Product</i>	
8200AAB	PumPac Triplex Set Of Angular Contact Ball Bearings	179
8200BB	PumPac Diamond Duplex Pair Of Angular Contact Ball Bearings	178
8300	PumPac Duplex Pair Of Angular Contact Ball Bearings	177
8300AAB	PumPac Triplex Set Of Angular Contact Ball Bearings	179
8300BB	PumPac Diamond Duplex Pair Of Angular Contact Ball Bearings	178
8500	Single-Row Felt Seal Replacement With One Seal	224
8600	Single-Row Felt Seal Replacement With One Seal	224
87000	Single-Row Felt Seal Replacement With One Shield And One Seal	224
87500	Single-Row Felt Seal Replacement With One Shield And One Seal	224
88000	Single-Row Felt Seal Replacement With Two Seals	225
88500	Single-Row Felt Seal Replacement With Two Seals	225
9100UK	Single-Row 29 Degree Split Inner Ring Angular Contact Ball Bearing	120
9200U	Single-Row 29 Degree Split Inner Ring Angular Contact Ball Bearing	120
9200UP	Single-Row 40 Degree Split Inner Ring Angular Contact Ball Bearing	125
9300U	Single-Row 29 Degree Split Inner Ring Angular Contact Ball Bearing	121
9300UP	Single-Row 40 Degree Split Inner Ring Angular Contact Ball Bearing	125
97000U	Matched Set Of 9000UDT And 7000DT 29 Degree Angular Contact Ball Bearings	129
97000UP	Matched Set Of 9000UPDT And 7000 PDT 40 Degree Angular Contact Ball Bearings	129

Product Index Alphabetical Order

<i>Series</i>		<i>Page</i>
<i>Designation</i>	<i>Product</i>	
AN	Locknut	309
CONV3SF	Conveyor Roll Ball Bearing	203
CONV3Y2	Conveyor Roll Ball Bearing	203
CONV3Y4	Conveyor Roll Ball Bearing	203
CONV4E2	Conveyor Roll Ball Bearing	203
CONV4SF	Conveyor Roll Ball Bearing	203
CONV4SZZ2	Conveyor Roll Ball Bearing	203
CONV5043	Conveyor Roll Ball Bearing	204
D2500	Double-Ended Stub Shaft For Conveyor Roll Bearing	204
D2625	Double-Ended Stub Shaft For Conveyor Roll Bearing	204
D3000	Double-Ended Stub Shaft For Conveyor Roll Bearing	204
H200	Adapter Sleeve For Tapered Bore Bearing	146
H300	Adapter Sleeve For Tapered Bore Bearing	147
H3000	Adapter Sleeve For Tapered Bore Bearing	146
J078DF-		
J400DF	Ball Screw Support Bearings	196
J078DFDT-		
J400DFDT	Ball Screw Support Bearings	196
N	Locknut	330
R2-R24	Single-Row Deep Groove Ball Bearing	45
R2A-R4A	Single-Row Deep Groove Ball Bearing	45
R2AF-R4AF	Single-Row Deep Groove Ball Bearing With One Shield	45
R2AFF-R4AFF	Single-Row Deep Groove Ball Bearing With Two Shields	45
R2AZ-R4AZ	Single-Row Deep Groove Ball Bearing With One Seal	45
R2AZZ-		
R4AZZ	Single-Row Deep Groove Ball Bearing With Two Seals	45
R2F-R24F	Single-Row Deep Groove Ball Bearing With One Shield	45
R2FF-R24FF	Single-Row Deep Groove Ball Bearing With Two Shields	45

Series		Page
Designation	Product	
R2Z-R20Z	Single-Row Deep Groove Ball Bearing With One Seal	45
R2ZZ-R20ZZ	Single-Row Deep Groove Ball Bearing With Two Seals	45
S1936	Single-Ended Stub Shaft For Conveyor Roll Bearing	204
S2500	Single-Ended Stub Shaft For Conveyor Roll Bearing	204
S3000	Single-Ended Stub Shaft for Conveyor Roll Bearing	204
S4125	Single-Ended Stub Shaft for Conveyor Roll Bearing	204
SNW	Adapter Sleeve For Tapered Bore Bearing	202
W00	Lockwasher	330
WC87000	Single-Row Felt Seal Replacement With One Shield And One Seal	224
WC87500	Single-Row Felt Seal Replacement With One Shield And One Seal	224
XLS	Single-Row 15 Degree Angular Contact Ball Bearing	76
X0	Ex-Cell-O Spindle Bearing	198

NOTES

NOTES