

Features

- Convenient Push-Twist and Click connection
- Dual-guide sleeve tabs ensure smooth action
- Corrosion resistant componentry improves performance
- Highly versatile selection of end configurations.
- Available in plated steel, brass or 303 stainless steel
- Conforms to the MIL-C-3486 Interchange Standard

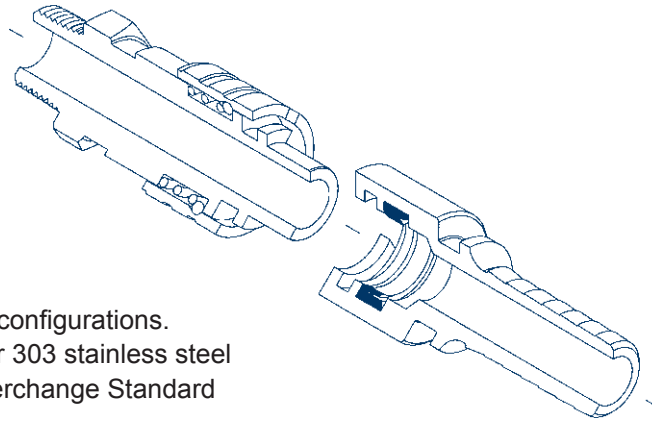

Performance Specifications

Body Size	Working Pressure		Failure Pressure		Vacuum Data	Flow Capacity $\Delta p=6\text{PSI}$ (90PSI @ 68°F)	Locking Mechanism
	PSI	bar	PSI	bar			
1/2"	300	21	3000	207	Not Recommended	125 SCFM	latch tabs

Material Configuration

Body Size	Structural Components	Seals	Operating Components
Couplers	Standard	Zinc plated steel body	Nitrile (Buna-N)
	Optional	Brass and 303 stainless steel	
Nipples	Standard	Zinc plated steel body & sleeve	Phosphor bronze retaining ring & spring
	Optional	Brass and 303 stainless steel	Steel flanged sleeve

Dimensional Specifications

Dimensional Reference Graphic (inches)	Body Size	End Size	Overall Length (A)				O.D. (B)	Hex Size (if applicable)
			Female NPTF	Female BSPP	Male NPTF	Collar Barb		
	1/2"	3/8"	1.63	-	1.77	2.98	1.54	1-3/8"
	1/2"	1/2"	1.63	-	1.77	3.37	1.54	1-3/8"
	1/2"	3/4"	1.63	-	1.77	3.37	1.54	1-3/8"
	1/2"	3/8"	2.73	-	3.65	4.36	1.40	1-1/8"
	1/2"	1/2"	2.73	-	3.65	4.63	1.40	1-1/8"
	1/2"	3/4"	3.34	-	3.74	4.77	1.40	1-3/8"

The Importance of "Whip Hose"

The constant vibration created by air tools, like air drills and pavement breakers, is destructive to air hose couplings, especially the quick-acting type. To provide a safer working environment, connect one end of a 3' to 10' length of air hose to the tool using Dixon's "No. 3500" Steel Nipple. This nipple is designed to specifically handle vibration applications. Connect the other end of hose to the air supply using the standard quick-acting coupling. The "Whip Hose" should remain permanently connected to the tool.

SAFETY

Dixon's couplings and retention devices are designed to work safely for their intended use. The selection of the proper hose, coupling and retention device, and the proper application of the coupling to the hose are of utmost importance.

Users must consider the size, temperature, application, media, pressure and hose and coupling manufacturer's recommendations when selecting the proper hose assembly components. Dixon recommends that all hose assemblies be tested in accordance with the Rubber Manufacturers Association's recommendations and be inspected regularly (before each use) to ensure that they are not damaged or have become loose. Visit RMA.org for more information. Where safety devices are integral to the coupling, they must be working and utilized. The use of supplementary safety devices such as safety clips or safety cables are recommended. If any problem is detected, couplings must be removed from service immediately.

Dixon is available to consult, train and recommend the proper selection and application of all fittings we sell. We strongly recommend that distributors and end users make use of Dixon's Testing and Recommendation Services. Call 877-963-4966 or click dixonvalve.com to learn more.



"Dix-Lock" Quick Acting Couplings

- It takes a minimum of 5 PSI to get a positive seal
- "Dix-Lock" is rated to **300 PSI**

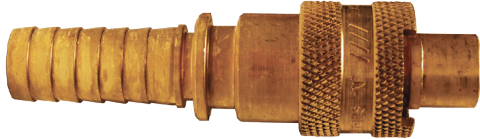
Body Size	Hose Shank Size	Material	Part #	Pkg Qty	Male Head x Hose End
1/2"	3/8"	plated steel	QM2	25	
1/2"	1/2"	plated steel	QM3	25	
1/2"	3/4"	plated steel	QM4	25	
1/2"	3/8"	brass	QB2	-	
1/2"	1/2"	brass	QB3	-	
1/2"	3/4"	brass	QB4	-	
1/2"	3/4"	stainless steel	QSS4	-	

Body Size	Hose Shank Size	Material	Part #	Pkg Qty	Female Head x Hose End
1/2"	3/8"	plated steel	QM21	25	
1/2"	1/2"	plated steel	QM22	25	
1/2"	3/4"	plated steel	QM23	25	
1/2"	3/8"	brass	QB21	-	
1/2"	1/2"	brass	QB22	-	
1/2"	3/4"	brass	QB23	-	
1/2"	3/4"	stainless steel	QSS23	-	

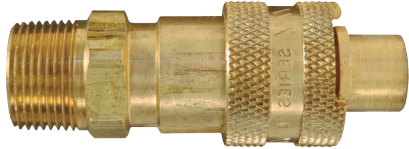
Body Size	NPT Thread Size	Material	Part #	Pkg Qty	Male Head x Male NPT End
1/2"	3/8"	plated steel	QM41	25	
1/2"	1/2"	plated steel	QM42	25	
1/2"	3/4"	plated steel	QM43	25	
1/2"	3/8"	brass	QB41	-	
1/2"	1/2"	brass	QB42	-	
1/2"	3/4"	brass	QB43	-	
1/2"	3/4"	stainless steel	QSS43	-	

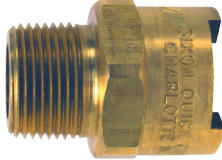
Body Size	NPT Thread Size	Material	Part #	Pkg Qty	Female Head x Male NPT End
1/2"	3/8"	plated steel	QM61	25	
1/2"	1/2"	plated steel	QM62	25	
1/2"	3/4"	plated steel	QM63	25	
1/2"	3/8"	brass	QB61	-	
1/2"	1/2"	brass	QB62	-	
1/2"	3/4"	brass	QB63	-	
1/2"	3/4"	stainless steel	QSS63	-	

Optional Pkg./Box Quantity Shown

"Dix-Lock" Quick Acting Couplings

- It takes a minimum of 5 PSI to get a positive seal
- "Dix-Lock" is rated to **300 PSI**

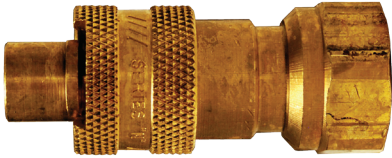
Male Head x Female NPT End	Body Size	NPT Thread Size	Material	Part #	Pkg Qty
	1/2"	3/8"	plated steel	QM81	25
	1/2"	1/2"	plated steel	QM82	25
	1/2"	3/4"	plated steel	QM83	25
	1/2"	3/8"	brass	QB81	-
	1/2"	1/2"	brass	QB82	-
	1/2"	3/4"	brass	QB83	-
	1/2"	3/4"	stainless steel	QSS83	-

Female Head x Female NPT End	Body Size	NPT Thread Size	Material	Part #	Pkg Qty
	1/2"	3/8"	plated steel	QM101	25
	1/2"	1/2"	plated steel	QM102	25
	1/2"	3/4"	plated steel	QM103	25
	1/2"	3/8"	brass	QB101	-
	1/2"	1/2"	brass	QB102	-
	1/2"	3/4"	brass	QB103	-
	1/2"	3/4"	stainless steel	QSS103	-

Optional Pkg./Box Quantity Shown

Male Locking Head x Hose Shank	Body Size	Hose Shank Size	Material	Part #
	1/2"	1/2"	plated steel	QM33
	1/2"	3/4"	plated steel	QM44
	1/2"	1/2"	brass	QB33
	1/2"	3/4"	brass	QB44

Male Locking Head x Male NPT	Body Size	NPT Thread Size	Material	Part #
	1/2"	1/2"	plated steel	QM66
	1/2"	3/4"	plated steel	QM88
	1/2"	1/2"	brass	QB66
	1/2"	3/4"	brass	QB88

POSITIVE SAFETY LOCK

With locking nut in place sleeve cannot be moved to open coupling.





Not for use with "Air King" or "Boss" clamps.

"Dix-Lock" Quick-Acting Couplings with Ferrules

- "Dix-Lock" Quick-acting Couplings with ferrules can be crimped or swaged-on
- Rated to **300 PSI** working pressure
- Plated steel ferrule
- For crimp or swage diameter recommendations see page 6

Body Size	Hose ID	O.D. Range From:	O.D. Range To:	Material	Part #	Male Head
1/2"	1/2"	27/32"	1-1/32"	plated steel	QM3WF	
1/2"	3/4"	1-5/32"	1-11/32"	plated steel	QM4WF	
1/2"	1/2"	27/32"	1-1/32"	brass	QB3WF	
1/2"	3/4"	1-5/32"	1-11/32"	brass	QB4WF	

Body Size	Hose ID	O.D. Range From:	O.D. Range To:	Material	Part #	Female Head
1/2"	1/2"	27/32"	1-1/32"	plated steel	QM22WF	
1/2"	3/4"	1-5/32"	1-11/32"	plated steel	QM23WF	
1/2"	1/2"	27/32"	1-1/32"	brass	QB22WF	
1/2"	3/4"	1-5/32"	1-11/32"	brass	QB23WF	

Body Size	Hose ID	O.D. Range From:	O.D. Range To:	Material	Part #	Male Locking Head
1/2"	1/2"	27/32"	1-1/32"	plated steel	QM33WF	
1/2"	3/4"	1-5/32"	1-11/32"	plated steel	QM44WF	
1/2"	1/2"	27/32"	1-1/32"	brass	QB33WF	
1/2"	3/4"	1-5/32"	1-11/32"	brass	QB44WF	

Note: Also available in stainless steel, contact the factory for further information.

"Dix-Lock" Gaskets (Buna-N)

Part #
QBM2



"Dix-Lock" Converter

Part #	Material	Pkg Qty
QM0	Steel	25



"KING" Safety Cables



When hose, couplings or clamps fail, or there is an accidental separation of the assembly, King Safety Cables minimize damage to equipment and injuries to operators. KING SAFETY CABLE reaches across the hose fittings to provide standby safety for hose. Spring-loaded loops in the cable ends open easily to pass over the couplings for a firm grip on the hose. Thoroughly tested with years of service. A positive safeguard for air hose connections - helps you meet today's safety standards. *KING SAFETY CABLE must be installed in the extended position (no slack).*

- Hose-to-hose or hose-to-rigid outlet
- King Cable is the low cost answer to eliminate injuries caused by broken air hose connections

Features:

- Highly resistant to rust and corrosion
- No tools needed - Easy to install and remove



Hose End

Tool End

Style WSR, for hose-to-tool service

Cable	Part #	Hose I.D.	Length	Maximum Working Pressure PSI
1/8"	WSR1	1/2" to 1-1/4"	20-1/4"	200
3/16"	WSR3	1/2" to 2"	28"	200
1/4"	WSR2	1-1/2" to 3"	38"	200
3/8"	WSR4	4"	44"	200



Hose End

Hose End

Style W, for hose-to-hose service

Cable	Part #	Hose I.D.	Length	Maximum Working Pressure PSI
1/8"	WB1	1/2" to 1-1/4"	20-1/4"	200
3/16"	WB3	1/2" to 2"	28"	200
1/4"	WA2	1-1/2" to 3"	38-1/4"	200
3/8"	WA4	4"	44"	200

Note: Cables are shipped with safety restraint labels attached. Labels are not pictured. Other cable options are available.

Reference OSHA regulations standards - 29 CFR, 1915.131, 1926.302, and 1926.603.

Crimped "Dix-Lock" Recommendation Guide

The chart at the right is only a guide. It will not apply to every coupling situation. In some instances alternative dies and crimping dimensions must be employed to ensure safety. Experience has shown that variances in the construction of similar hoses and couplings may cause some assemblies to react differently when crimped. It is not uncommon to find hose with an outer diameter that fluctuates from one end to the other or from production lot to production lot. These inconsistencies coupled with the inherent differences between textile or wire braid, hard or soft wall, the presence or absence of an internal spiral wire and the differences in hose coverings make it difficult to establish hard and fast rules. Therefore, it is imperative that hose dimensions are accurately measured, assemblies are tested, and documentation is maintained.

Part#

QM3WF, QB3WF, QM22WF, QB22WF, QM33WF, QB33WF







Hose I.D.	Measured Hose O.D.		Crimp Length	"Dix-Lock" Crimp O.D. ± .005
	Fractional	Decimal		
1/2"	54/64"	0.844	1-1/8"	0.968
1/2"	55/64"	0.859	1-1/8"	0.968
1/2"	56/64"	0.875	1-1/8"	0.968
1/2"	57/64"	0.891	1-1/8"	1.000
1/2"	58/64"	0.906	1-1/8"	1.000
1/2"	59/64"	0.922	1-1/8"	1.031
1/2"	60/64"	0.938	1-1/8"	1.031
1/2"	61/64"	0.953	1-1/8"	1.062
1/2"	62/64"	0.969	1-1/8"	1.062
1/2"	63/64"	0.984	1-1/8"	1.062
1/2"	1"	1.000	1-1/8"	1.093
1/2"	1-1/64"	1.016	1-1/8"	1.093
1/2"	1-2/64"	1.031	1-1/8"	1.093

Part#

QM4WF, QB4WF, QM23WF, QB23WF, QM44WF, QB44WF

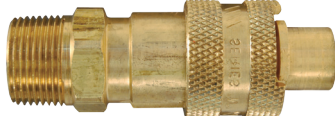
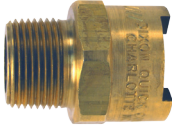
Hose I.D.	Measured Hose O.D.		Crimp Length	"Dix-Lock" Crimp O.D. ± .005
	Fractional	Decimal		
3/4"	1-10/64"	1.156	1-1/4"	1.218
3/4"	1-11/64"	1.172	1-1/4"	1.218
3/4"	1-12/64"	1.188	1-1/4"	1.218
3/4"	1-13/64"	1.203	1-1/4"	1.250
3/4"	1-14/64"	1.219	1-1/4"	1.250
3/4"	1-15/64"	1.234	1-1/4"	1.281
3/4"	1-16/64"	1.250	1-1/4"	1.281
3/4"	1-17/64"	1.266	1-1/4"	1.281
3/4"	1-18/64"	1.281	1-1/4"	1.312
3/4"	1-19/64"	1.297	1-1/4"	1.312
3/4"	1-20/64"	1.313	1-1/4"	1.343
3/4"	1-21/64"	1.328	1-1/4"	1.343
3/4"	1-22/64"	1.344	1-1/4"	1.375

"Dix-Lock" Interchange Guide

Size	Material	Dixon Part #	Perfecting Part #	Bowes Part #	National Part #	
3/8"	steel	QM2	HM3E	51522	BMH6	 Male Head x Hose End  Female Head x Hose End  Male Head x Male NPT End  Female Head x Male NPT End  Male Head x Female NPT End  Female Head x Female NPT End  Male Locking Head x Hose Shank  Male Locking Head x Male NPT
	brass	QB2	HM3B	51462	B-BMH6	
1/2"	steel	QM3	HM4E	51524	BMH8	
	brass	QB3	HM4B	51464	B-BMH8	
3/4"	steel	QM4	HM6E	51526	BMH12	
	brass	QB4	HM6B	51466	B-BMH12	
3/8"	steel	QM21	HF3E	51532	BFH6	
	brass	QB21	HF3B	51472	B-BFH6	
1/2"	steel	QM22	HF4E	51534	BFH8	
	brass	QB22	HF4B	51474	B-BFH8	
3/4"	steel	QM23	HF6E	51536	BFH12	
	brass	QB23	HF6B	51476	B-BFH12	
3/8"	steel	QM41	OM3E	51542	BMM6	
	brass	QB41	OM3B	51482	B-BMM6	
1/2"	steel	QM42	OM4E	51544	BMM8	
	brass	QB42	OM4B	51484	B-BMM8	
3/4"	steel	QM43	OM6E	51546	BMM12	
	brass	QB43	OM6B	51486	B-BMM12	
3/8"	steel	QM61	OF3E	51552	BFM6	
	brass	QB61	OF3B	51492	B-BFM6	
1/2"	steel	QM62	OF4E	51554	BFM8	
	brass	QB62	OF4B	51494	B-BFM8	
3/4"	steel	QM63	OF6E	51556	BFM12	
	brass	QB63	OF6B	51496	B-BFM12	
3/8"	steel	QM81	IM3E	51562	BMF6	
	brass	QB81	IM3B	51502	B-BMF6	
1/2"	steel	QM82	IM4E	51564	BMF8	
	brass	QB82	IM4B	51504	B-BMF8	
3/4"	steel	QM83	IM6E	51566	BMF12	
	brass	QB83	IM6B	51506	B-BMF12	
3/8"	steel	QM101	IF3E	51572	BFF6	
	brass	QB101	IF3B	51512	B-BFF6	
1/2"	steel	QM102	IF4E	51574	BFF8	
	brass	QB102	IF4B	51514	B-BFF8	
3/4"	steel	QM103	IF6E	51576	BFF12	
	brass	QB103	IF6B	51516	B-BFF12	
1/2"	steel	QM33	SHM4E	51524-1	BMH8-LN	
	brass	QB33	SHM4B	51464-1	B-BMH8-LN	
3/4"	steel	QM44	SHM6E	51526-1	BMH12-LN	
	brass	QB44	SHM6B	51466-1	B-BMH12-LN	
1/2"	steel	QM66	SOM4E	51544-1	BMM8-LN	
	brass	QB66	SOM4B	51484-1	B-BMM8-LN	
3/4"	steel	QM88	SOM6E	51546-1	BMM12-LN	
	brass	QB88	SOM6B	51486-1	B-BMM12-LN	

Dixon is recognized as the premier manufacturer and supplier of hose fittings and accessories spanning a wide range of industrial uses. Dixon's range includes products for food, dairy processing, beverage and brewery, mobile tankers, mining, construction, chemical processing, petroleum, oilfields, refining and manufacturing.

dixonvalve.com • *Customer Service:* 877.963.4966



The Right Connection™

Dixon Valve

800 High Street, Chestertown, MD 21620

ph: 877.963.4966

fx: 800.283.4966



Dixon Customer Service



Facebook Page



YouTube Videos

